

C 091 A/B/D Series

Circular Connectors



Note from the CEO



Ladies and Gentlemen,

For over 75 years Amphenol has enjoyed success as the interconnection technology provider of choice to industry-leading companies around the world. One of our key strategic areas of focus has been and is the Industrial market. Our organization works with leading manufacturers across a wide range of applications - including Energy Generation & Distribution, Transportation, Heavy Equipment, Factory Automation, Wireless Outdoor, ChipCard Readers - enabling smarter, faster and better technologies to connect products to customer solutions.

The Industrial market footprint of Amphenol covers over facilities in more than 12 different European countries and more than 30 countries worldwide. Our successful expansion into new regions as well as new industrial applications is a direct reflection of our agile, entrepreneurial management team and our unwavering commitment to execute Amphenol's strategies for the benefit of our customers, shareholders and employees.

Thank you for partnering with Amphenol. Our entire organization is at your service.

A handwritten signature in black ink, appearing to read 'R. Adam Norwitt'. The signature is fluid and stylized, with a large initial 'R'.

R. Adam Norwitt
President and CEO, Amphenol Corporation

Make use of the best

Use our global resources

“Think global, act local!” Independently from where you are in Europe, we offer you our global expertise and great variety of products and technologies. And in comfort with your personal contact. Our numerous European offices are your access to our global resources.

● OUR OFFICES IN EUROPE AND WORLDWIDE

FRANCE	CHINA	AUSTRALIA	SOUTH AFRICA
GERMANY	KOREA	MEXICO	INDIA
UNITED KINGDOM	TAIWAN	USA	ITALY

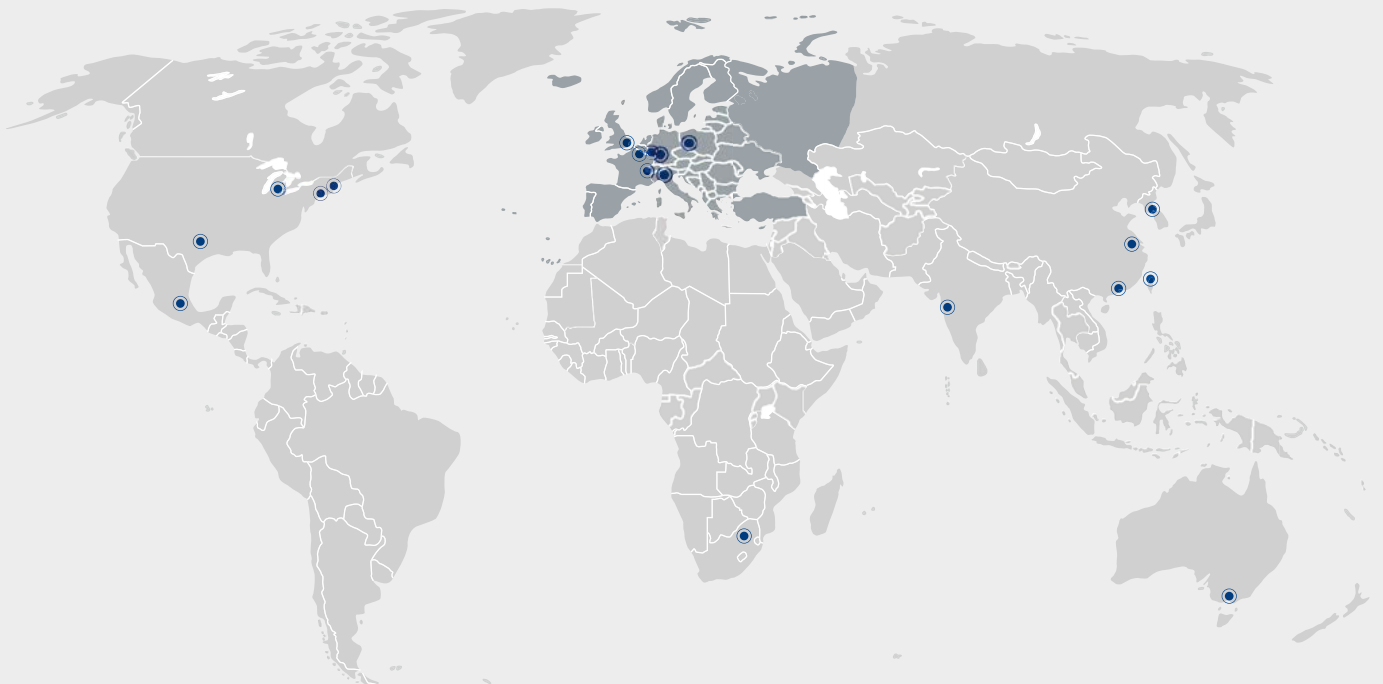

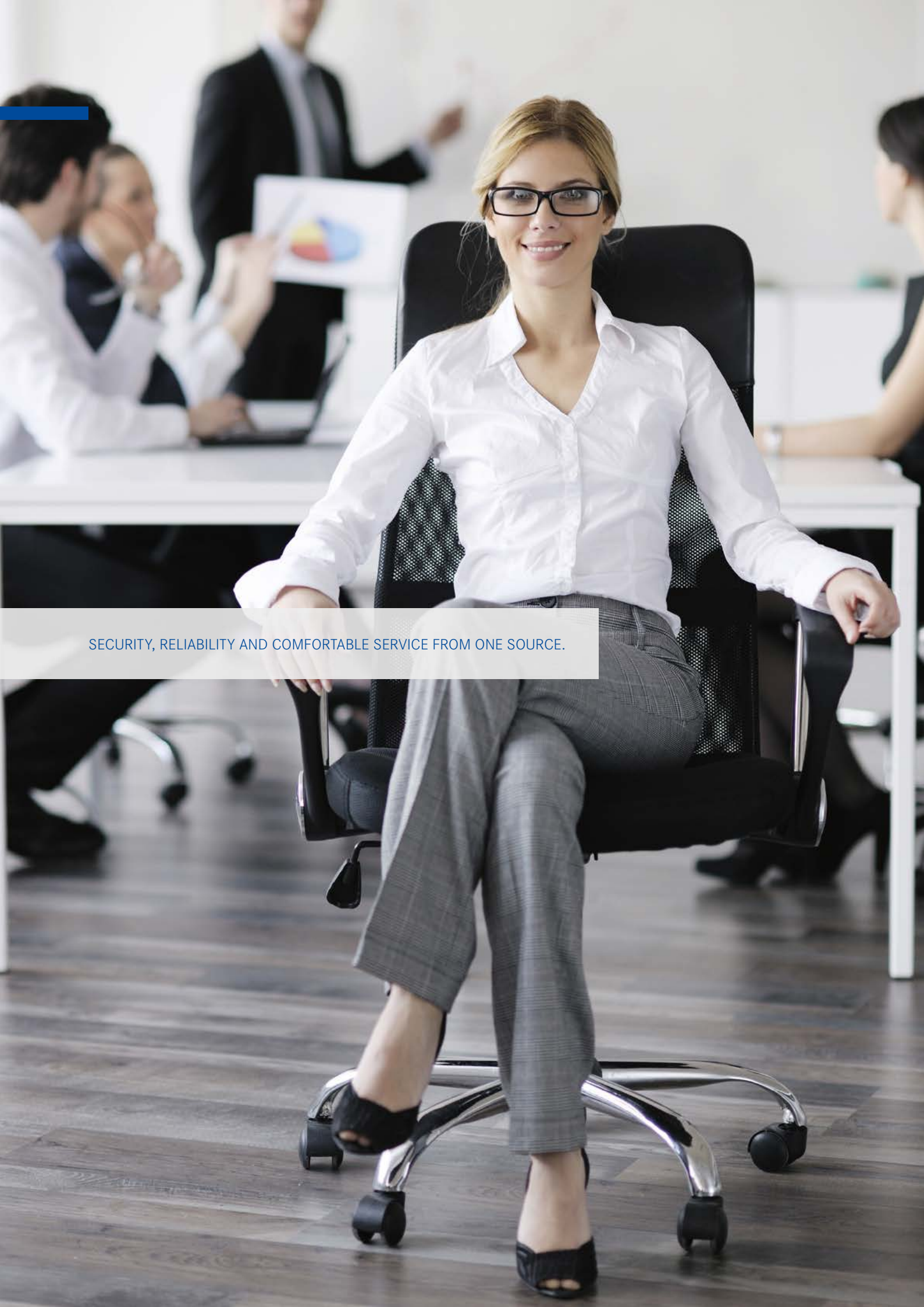

SECURITY, RELIABILITY AND COMFORTABLE SERVICE FROM ONE SOURCE.

More time for important things: benefit from our service and diversity

Enjoy security, reliability and comfortable service from one source. INDUSTRIAL@AMPHENOL offers one of the most individual and most diversified service programmes in the market – exclusively for industrial customers. Access all possibilities of the Amphenol group through your personal expert adviser.



WIDE PRODUCT RANGE

Take advantage of a choice of Amphenol products. Our broad product portfolio offers individual solutions from more than 90 member companies in the global Amphenol group.



EXCLUSIVENESS AND FLEXIBILITY

One face to the customer: every inquiry is handled on an individual service level by your personal key account service partner. This ensures maximum transparency and best-in-class flexibility in the whole process.



QUALITY

Interconnect systems need reliability, speed and flawless data transmission. We continuously test and guarantee the required standard in our products – and also in our personal services.



INDIVIDUAL SOLUTIONS

Your project requires an individual solution that is not available off-the-shelf? As your think tank and discussion partner we provide engineering support and solution-oriented development for your tailor-made Amphenol product.



SPEED AND AVAILABILITY

Smart and intelligent processes are the secret behind our service programme. Flexible planning and distribution, perfect logistics and highest availability are our key factors for best customer service.



GLOBAL KEY ACCOUNT SERVICE

Our key account service is your individual entrance to global know-how, products and services. More than 90 Amphenol companies around the world offer an extensive range of technologies and products. We offer access to our worldwide resources through one individual contact person.











Content		Page
<p>C 091 A Circular connectors with metal screw coupling and plastic back shell. Contacts: 2 to 8, 12 and 14, IP 40 when properly mated. Shieldable.</p>		8
<p>C 091 B Circular connectors with plastic bayonet coupling and plastic back shell. Contacts: 2 to 8, 12 and 14, IP 40 when properly mated.</p>		24
<p>C 091 D Circular connectors with metal screw coupling and metal back shell. Contacts: 3 to 8, 12 and 14, IP 69K / IP 67 / IP 65 when properly mated. Shieldable. Connectors are compliant with AISG-standard</p>		40
<p>C 091 D+ Circular connectors with metal screw coupling and metal back shell. Contacts: 3 to 8, 12 and 14, IP 69K / IP 68 when properly mated. Shieldable. Connectors are compliant with AISG-standard</p>		52
Crimp contacts		56
Tools		57
Accessories		57
Protective Caps		58
Current-Derating-Curves		59
Remarks / Safety classification		60
IP Code		61
Summary of Part Numbers		62



C 091 A

- M16 size
- Screw locking according to IEC 61076-2-106
- Metal locking ring
- Shieldable
- 2 - 8, 12 and 14 positions for crimp and solder
- IP 40
- Internal strain relief
- Male and female cable connectors straight and angled
- Male and female receptacles for front and rear panel mounting and PCB mounting
- Coloured back shells optional
- UL registered under file number E 63 093 UL

C 091 A Characteristics

General Characteristics	Standard	Characteristics										
Number of contacts		2 ¹⁾ + 3	4	5	5 Stereo	6	7	7	8	12	14	
View on termination side of male contact insert												
Contact arrangement	DIN EN 61076-2-106	03-a ✓	04-a ✓	05-a ✓	05-b ✓	06-a ✓	07-a ✓	07-b ✓	08-a ✓	12-a ✓	14-a ✓	
Contact arrangement	IEC 60130-9 ²⁾	✓	✓		✓	✓		✓	✓			
Electrical Characteristics												
Rated voltage ³⁾	IEC 60664-1	300 V ≈ (100 V ≈)		300 V ≈ (63 V ≈)		100 V ≈ (32 V ≈)		300 V ≈ (63 V ≈)		100 V ≈ (32 V ≈)		150 V ≈ (32 V ≈)
Rated voltage	UL 1977	250 V									60 V	
Rated impulse withstand voltage ³⁾	IEC 60664-1	1500 V (840 V)			1200 V (500 V)		1500 V (840 V)			1200 V (500 V)		
Pollution degree ³⁾	IEC 60664-1	1 (2)										
Installation category	IEC 60664-1	I										
Insulation group	IEC 60664-1	II, 400 ≤ CTI < 600										
Current rating	IEC 60512-5-2 UL 1977	10 A / + 40 °C				7 A / + 40 °C					3 A / + 40 °C / + 104 °F	
Insulation resistance	IEC 60512-3-1	> 10 ¹⁰ Ω ⁴⁾										
Contact resistance	IEC 60512-2-1	< 5 m Ω										
Climatic Characteristics												
Climatic category	IEC 60068-1	40 / 100 / 56										
Temperature range	IEC 60068-1	- 40 °C ... + 100 °C / - 40 °F ... + 212 °F										
Mechanical Characteristics												
IP-degree	IEC 60529	IP 40										
Insertion and withdrawal forces	IEC 60512-13-2	25 N 90.oz	30 N 110.oz	35 N 125.oz	50 N 180.oz	55 N 200.oz	60 N 220.oz	50 N 180.oz				
Mechanical operation	IEC 60512-9-1	Silver ≥ 500 mating cycles Gold ≥ 1000 mating cycles										
Materials												
Housing material		brass or zinc die cast nickel plated or thermoplast										
Dielectric material		thermoplastic										
Contact plating		silver plated / gold plated ⁵⁾										
Further Characteristics												
Termination technique		solder, crimp										
Wire gauge		solder: ≤ 0,5 mm ² / 20 AWG crimp: 2 - 6 pol (excluding 5S): 0,09 - 1,00 mm ² / 28 - 18 AWG crimp: 5S, 7, 7S and 8-pol.: 0,09 - 0,75 mm ² / 28 - 20 AWG								solder: ≤ 0,25 mm ² / 24 AWG crimp: 0,09-0,25 mm ² / 28 - 24 AWG		
Flammability		UL 94 V0										
Locking system	IEC 60130-9 DIN EN 61076-2-106	metal screw coupling; tightening torque 1,0 Nm										

Caution: Do not connect or disconnect under load. Metal housing parts shall be securely incorporated to protected ground.

¹⁾ 2 contact version: contact loading 1+3

²⁾ Edition 2000-05









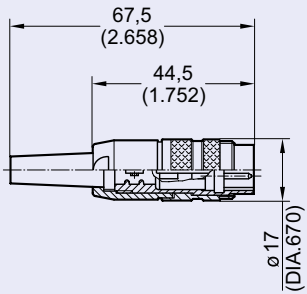

³⁾ Values in brackets are according to DIN EN 61076-2-106

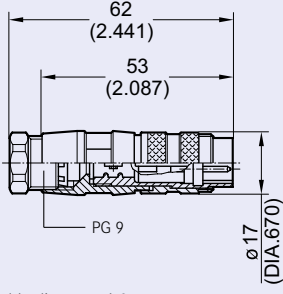
⁴⁾ Under operating conditions >10⁸ Ω

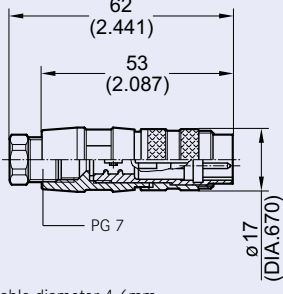
⁵⁾ Remark for gold plated contacts: In order to avoid brittle inter-metallic connections, gold-plated terminals have to be tin-plated in the solder area.

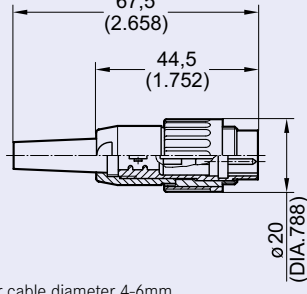
IEC 60 664 ≙ DIN VDE 0110; IEC 60 512-x ≙ DIN EN 60 512-x; IEC 60 130-9 ≙ DIN EN 60 130-9; IEC 61076-2-106 ≙ DIN EN 61076-2-106

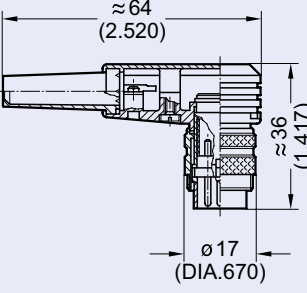
C 091 A Male cable connector

No. of cont.	Part Number solder termination		Part Number crimp termination	Drawing	Figure		
	silver plating	gold plating ¹⁾					
Straight (Please order crimp contacts separately, see page 56)							
2	T 3200 001	T 3200 018	T 3200 551	 <p>for cable diameter 4-6mm</p>			
3	T 3260 001	T 3260 018	T 3260 551				
4	T 3300 001	T 3300 018	T 3300 551				
5	T 3360 001	T 3360 018	T 3360 551				
5S ²⁾	T 3360 010	T 3356 018	T 3356 551				
6	T 3400 001	T 3400 018	T 3400 551				
7	T 3475 001	T 3475 018	T 3475 551				
7 ²⁾	T 3484 001	T 3484 018	T 3484 551				
8	T 3504 001	T 3504 018	T 3504 551				
12	T 3635 001	T 3635 000	T 3635 551				
14	T 3650 001	T 3650 000	T 3650 551				
2	T 3200 002	T 3200 028	T 3200 552			 <p>for cable diameter 6-8mm</p>	
3	T 3260 002	T 3260 028	T 3260 552				
4	T 3300 002	T 3300 028	T 3300 552				
5	T 3360 002	T 3360 028	T 3360 552				
5S ²⁾	T 3360 020	T 3356 028	T 3356 552				
6	T 3400 002	T 3400 028	T 3400 552				
7	T 3475 002	T 3475 028	T 3475 552				
7 ²⁾	T 3484 002	T 3484 028	T 3484 552				
8	T 3504 002	T 3504 028	T 3504 552				
12	T 3635 020	T 3635 002	T 3635 552				
14	T 3650 020	T 3650 002	T 3650 552				
2	T 3200 004	T 3200 048	T 3200 554	 <p>for cable diameter 4-6mm</p>			
3	T 3260 004	T 3260 048	T 3260 554				
4	T 3300 004	T 3300 048	T 3300 554				
5	T 3360 004	T 3360 048	T 3360 554				
5S ²⁾	T 3356 004	T 3356 048	T 3356 554				
6	T 3400 004	T 3400 048	T 3400 554				
7	T 3475 004	T 3475 048	T 3475 554				
7 ²⁾	T 3484 004	T 3484 048	T 3484 554				
8	T 3504 004	T 3504 048	T 3504 554				
12	T 3635 024	T 3635 004	T 3635 554				
14	T 3650 024	T 3650 004	T 3650 554				
2	T 3200 013	T 3200 038	T 3200 556			 <p>for cable diameter 4-6mm</p>	
3	T 3260 013	T 3260 038	T 3260 556				
4	T 3300 013	T 3300 038	T 3300 556				
5	T 3360 013	T 3360 038	T 3360 556				
5S ²⁾	T 3360 130	T 3356 038	T 3356 556				
6	T 3400 013	T 3400 038	T 3400 556				
7	T 3475 013	T 3475 038	T 3475 556				
7 ²⁾	T 3484 013	T 3484 038	T 3484 556				
8	T 3504 013	T 3504 038	T 3504 556				
12	T 3635 013	T 3635 038	T 3635 556				
14	T 3650 013	T 3650 038	T 3650 556				
Right-angled (Please order crimp contacts separately, see page 56)							
2	T 3200 005	T 3200 058	T 3200 055	 <p>for cable diameter 4-6mm</p>			
3	T 3260 005	T 3260 058	T 3260 055				
4	T 3300 005	T 3300 058	T 3300 055				
5	T 3360 005	T 3360 058	T 3360 055				
5S ²⁾	T 3356 005	T 3356 058	T 3356 055				
6	T 3400 005	T 3400 058	T 3400 055				
7	T 3475 005	T 3475 058	T 3475 055				
7 ²⁾	T 3484 005	T 3484 058	T 3484 055				
8	T 3504 005	T 3504 058	T 3504 055				
12	T 3635 005	T 3635 058	T 3635 055				
14	T 3650 005	T 3650 058	T 3650 055				

C 091 A Male cable connector

Assembly instruction¹⁾, cable diameter 4-6mm

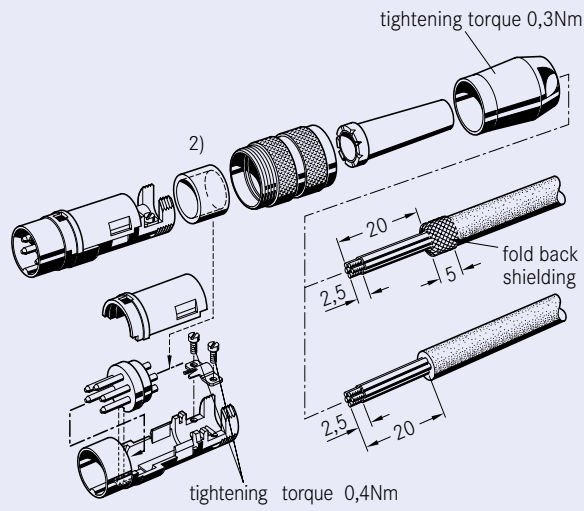



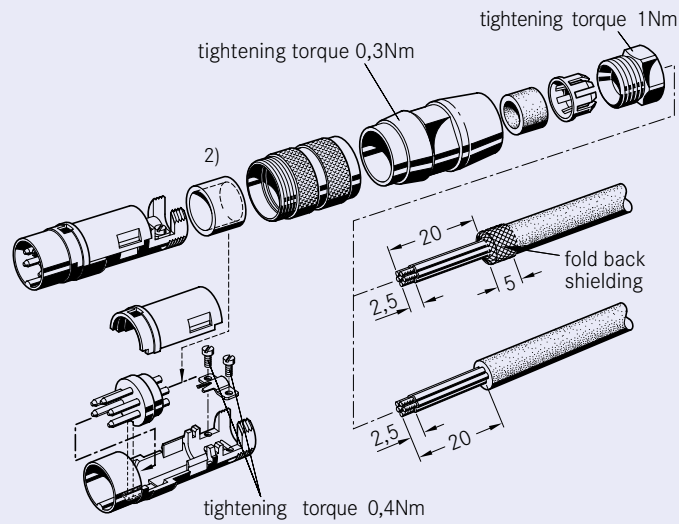



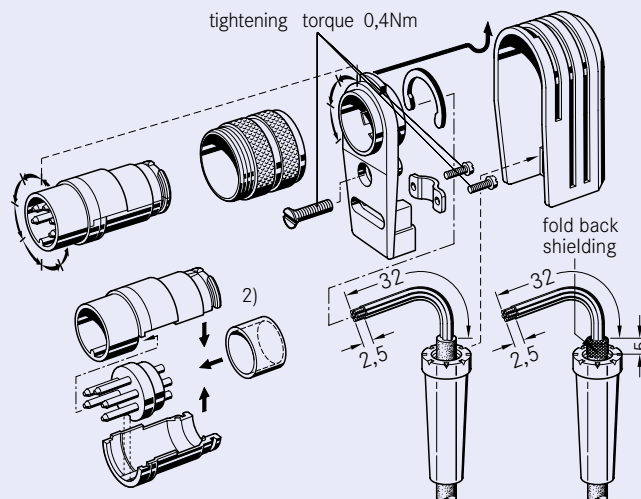

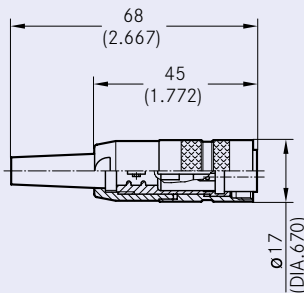

Assembly instruction¹⁾, cable diameter 4-6mm or 6-8mm

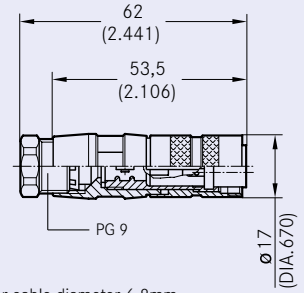

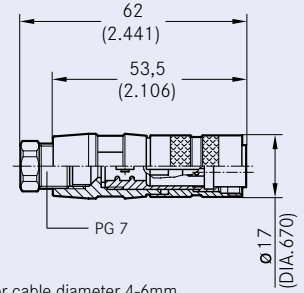
Assembly instruction¹⁾, right-angled, can be keyed to 8 angle positions

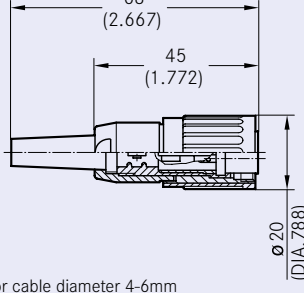

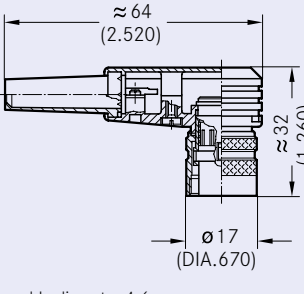
C 091 A Female cable connector

No. of cont.	Part Number solder termination		Part Number crimp termination	Drawing	Figure		
	silver plating	gold plating ¹⁾					
Straight (Please order crimp contacts separately, see page 56)							
2	T 3201 001	T 3201 018	T 3201 551	 <p>for cable diameter 4-6mm</p>			
3	T 3261 001	T 3261 018	T 3261 551				
4	T 3301 001	T 3301 018	T 3301 551				
5	T 3361 001	T 3361 018	T 3361 551				
5S ²⁾	T 3361 010	T 3357 018	T 3357 551				
6	T 3401 001	T 3401 018	T 3401 551				
7	T 3476 001	T 3476 018	T 3476 551				
7 ²⁾	T 3485 001	T 3485 018	T 3485 551				
8	T 3505 001	T 3505 018	T 3505 551				
12	T 3636 001	T 3636 000	T 3636 551				
14	T 3651 001	T 3651 000	T 3651 551				
2	T 3201 002	T 3201 028	T 3201 552			 <p>for cable diameter 6-8mm</p>	
3	T 3261 002	T 3261 028	T 3261 552				
4	T 3301 002	T 3301 028	T 3301 552				
5	T 3361 002	T 3361 028	T 3361 552				
5S ²⁾	T 3361 020	T 3357 028	T 3357 552				
6	T 3401 002	T 3401 028	T 3401 552				
7	T 3476 002	T 3476 028	T 3476 552				
7 ²⁾	T 3485 002	T 3485 028	T 3485 552				
8	T 3505 002	T 3505 028	T 3505 552				
12	T 3636 020	T 3636 002	T 3636 552				
14	T 3651 020	T 3651 002	T 3651 552				
2	T 3201 004	T 3201 048	T 3201 554	 <p>for cable diameter 4-6mm</p>			
3	T 3261 004	T 3261 048	T 3261 554				
4	T 3301 004	T 3301 048	T 3301 554				
5	T 3361 004	T 3361 048	T 3361 554				
5S ²⁾	T 3357 004	T 3357 048	T 3357 554				
6	T 3401 004	T 3401 048	T 3401 554				
7	T 3476 004	T 3476 048	T 3476 554				
7 ²⁾	T 3485 004	T 3485 048	T 3485 554				
8	T 3505 004	T 3505 048	T 3505 554				
12	T 3636 044	T 3636 004	T 3636 554				
14	T 3651 044	T 3651 004	T 3651 554				
2	T 3201 013	T 3201 038	T 3201 556			 <p>for cable diameter 4-6mm</p>	
3	T 3261 013	T 3261 038	T 3261 556				
4	T 3301 013	T 3301 038	T 3301 556				
5	T 3361 013	T 3361 038	T 3361 556				
5S ²⁾	T 3361 130	T 3357 038	T 3357 556				
6	T 3401 013	T 3401 038	T 3401 556				
7	T 3476 013	T 3476 038	T 3476 556				
7 ²⁾	T 3485 013	T 3485 038	T 3485 556				
8	T 3505 013	T 3505 038	T 3505 556				
12	T 3636 013	T 3636 038	T 3636 556				
14	T 3651 013	T 3651 038	T 3651 556				
Right-angled (Please order crimp contacts separately, see page 56)							
2	T 3201 005	T 3201 058	T 3201 055	 <p>for cable diameter 4-6mm</p>			
3	T 3261 005	T 3261 058	T 3261 055				
4	T 3301 005	T 3301 058	T 3301 055				
5	T 3361 005	T 3361 058	T 3361 055				
5S ²⁾	T 3357 005	T 3357 058	T 3357 055				
6	T 3401 005	T 3401 058	T 3401 055				
7	T 3476 005	T 3476 058	T 3476 055				
7 ²⁾	T 3485 005	T 3485 058	T 3485 055				
8	T 3505 005	T 3505 058	T 3505 055				
12	T 3636 005	T 3636 058	T 3636 055				
14	T 3651 005	T 3651 058	T 3651 055				

C 091 A Female cable connector

Assembly instruction¹⁾, cable diameter 4-6mm

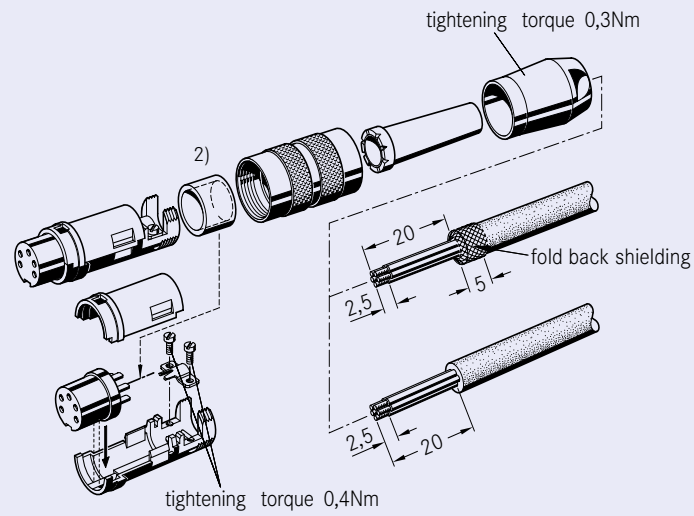

Assembly instruction¹⁾, cable diameter 4-6mm or 6-8mm

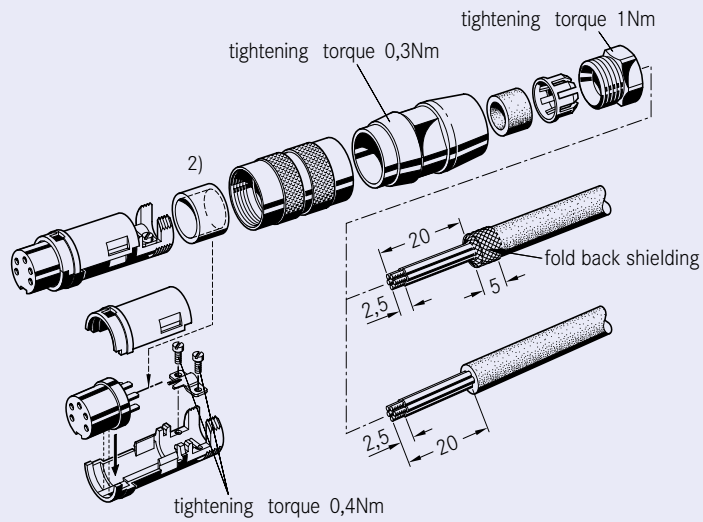

Assembly instruction¹⁾, right-angled, can be keyed to 8 angle positions

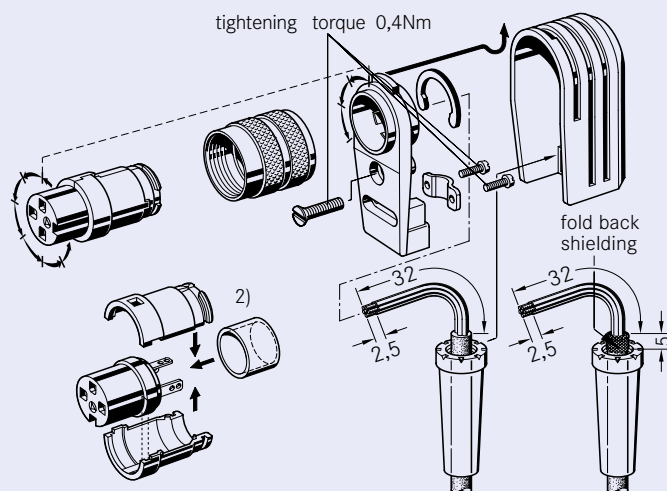

C 091 A Male receptacle | front mounting

No. of cont.	Part Number solder termination		Part Number crimp termination	Drawing	Figure
	silver plating	gold plating ¹⁾			

Ring Nut (Hex nut on request) (Please order crimp contacts separately, see page 56)

2	T 3202 000	T 3202 018	T 3202 550
3	T 3262 000	T 3262 018	T 3262 550
4	T 3302 000	T 3302 018	T 3302 550
5	T 3362 000	T 3362 018	T 3362 550
5S ²⁾	T 3362 010	T 3358 018	T 3358 550
6	T 3402 000	T 3402 018	T 3402 550
7	T 3477 000	T 3477 018	T 3477 550
7 ²⁾	T 3486 000	T 3486 018	T 3486 550
8	T 3506 000	T 3506 018	T 3506 550
12	T 3637 001	T 3637 000	T 3637 550
14	T 3652 001	T 3652 000	T 3652 550

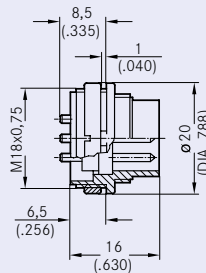

termination: solder or crimp



2	T 3262 300	T 3262 304	
3	T 3302 300	T 3302 304	
4	T 3362 300	T 3362 304	
5	T 3362 300	T 3362 304	
5S ²⁾	T 3358 300	T 3358 304	
6	T 3402 300	T 3402 304	
7	T 3477 300	T 3477 304	
7 ²⁾	T 3486 300	T 3486 304	
8	T 3506 300	T 3506 304	
12	T 3637 300	T 3637 304	
14	T 3652 300	T 3652 304	

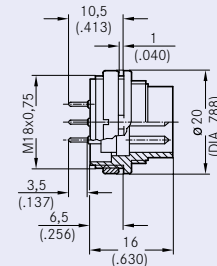

pin length 10.5 mm from flange
termination: straight dip solder



Assembly instruction ³⁾

Panel cutout

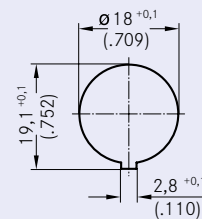
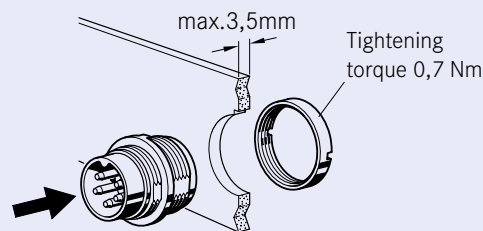

C 091 A Male receptacle | rear mounting

No. of cont.	Part Number solder termination		Part Number crimp termination	Drawing	Figure		
	silver plating	gold plating ¹⁾					
Ring Nut (Hex nut on request) (Please order crimp contacts separately, see page 56)							
2	T 3202 100	T 3202 118	T 3202 150	<p>termination: solder or crimp</p>			
3	T 3262 100	T 3262 118	T 3262 150				
4	T 3302 100	T 3302 118	T 3302 150				
5	T 3362 100	T 3362 118	T 3362 150				
5S ²⁾	T 3358 100	T 3358 118	T 3358 150				
6	T 3402 100	T 3402 118	T 3402 150				
7	T 3477 100	T 3477 118	T 3477 150				
7 ²⁾	T 3486 100	T 3486 118	T 3486 150				
8	T 3506 100	T 3506 118	T 3506 150				
12	T 3637 110	T 3637 100	T 3637 150				
14	T 3652 110	T 3652 100	T 3652 150				
3	T 3262 400	T 3262 404				<p>pin length 10.5 mm from flange termination: straight dip solder</p>	
4	T 3302 400	T 3302 404					
5	T 3362 400	T 3362 404					
5S ²⁾	T 3358 400	T 3358 404					
6	T 3402 400	T 3402 404					
7	T 3477 400	T 3477 404					
7 ²⁾	T 3486 400	T 3486 404					
8	T 3506 400	T 3506 404					
12	T 3637 400	T 3637 404					
14	T 3652 400	T 3652 404					
3	T 3262 420			<p>pin length 14.5 mm from flange termination: straight dip solder</p>			
4	T 3302 420						
5	T 3362 420						
5S ²⁾	T 3358 420						
6	T 3402 420						
7	T 3477 420						
7 ²⁾	T 3486 420						
8	T 3506 420						
12							
14							
3	T 3262 430					<p>pin length 19.5 mm from flange termination: straight dip solder</p>	
4	T 3302 430						
5	T 3362 430						
5S ²⁾	T 3358 430						
6	T 3402 430						
7	T 3477 430						
7 ²⁾	T 3486 430						
8	T 3506 430						
12							
14							

Assembly instruction ³⁾

Panel cutout

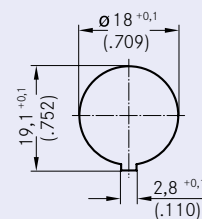
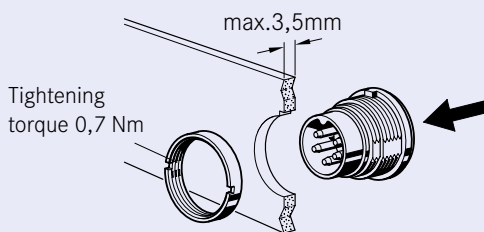

PCB-Layout (components side of circuit board)

Male Receptacles | front mounting | rear mounting | straight

3 POL

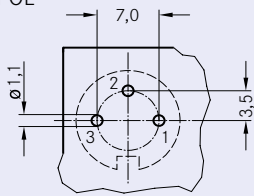

4 POL

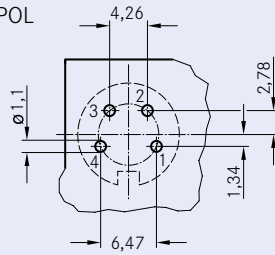

5 POL

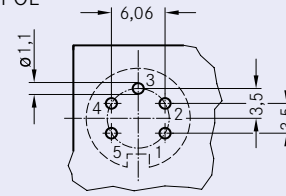

5 POL S ¹⁾

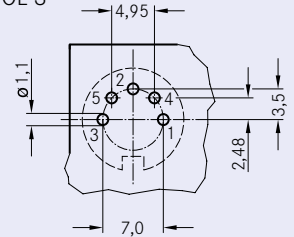

6 POL

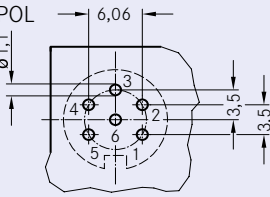

7 POL

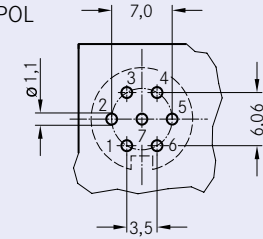

7 POL ¹⁾

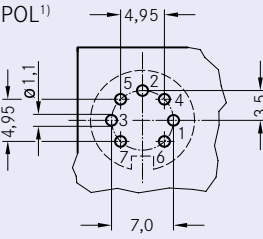

8 POL

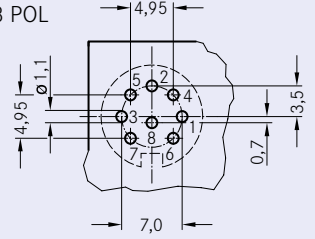

12 POL

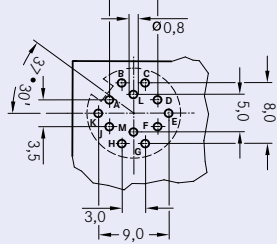

14 POL

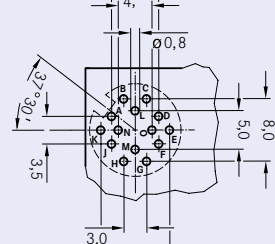





C 091 A Female receptacle | front mounting

No. of cont.	Part Number		Part Number crimp termination	Drawing	Figure
	solder termination silver plating	gold plating ¹⁾			

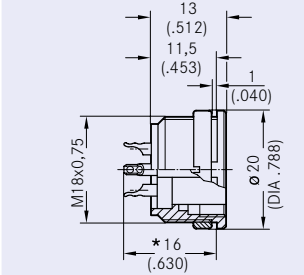
Ring Nut (Hex nut on request)

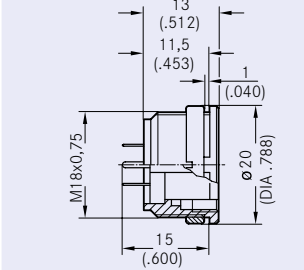
(Please order crimp contacts separately, see page 56)

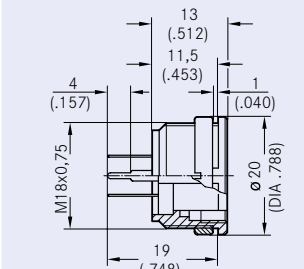
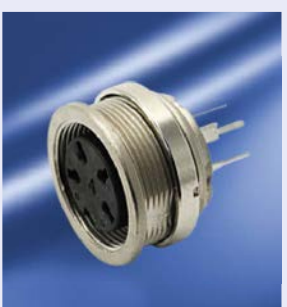
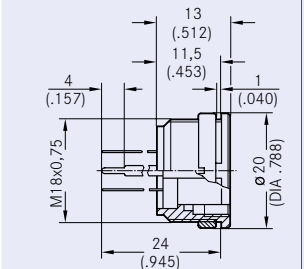
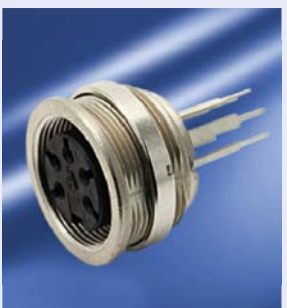
2	T 3203 000	T 3203 018	T 3203 550				
3	T 3263 000	T 3263 018	T 3263 550				
4	T 3303 000	T 3303 018	T 3303 550				
5	T 3363 000	T 3363 018	T 3363 550				
5S ²⁾	T 3363 010	T 3359 018	T 3359 550				
6	T 3403 000	T 3403 018	T 3403 550				
7	T 3478 000	T 3478 018	T 3478 550				
7 ²⁾	T 3487 000	T 3487 018	T 3487 550				
8	T 3507 000	T 3507 018	T 3507 550				
12	T 3638 000	T 3638 004	T 3638 550				
14	T 3653 000	T 3653 004	T 3653 550				
2	T 3203 300	T 3203 304					
3	T 3263 300	T 3263 304					
4	T 3303 300	T 3303 304					
5	T 3363 300	T 3363 304					
5S ²⁾	T 3359 300	T 3359 304					
6	T 3403 300	T 3403 304					
7	T 3478 300	T 3478 304					
7 ²⁾	T 3487 300	T 3487 304					
8	T 3507 300	T 3507 304					
12	T 3638 300	T 3638 304					
14	T 3653 300	T 3653 304					
2							
3	T 3263 320						
4	T 3303 320						
5	T 3363 320						
5S ²⁾	T 3359 320						
6	T 3403 320						
7	T 3478 320						
7 ²⁾	T 3487 320						
8	T 3507 320						
12							
14							
2							
3	T 3263 330						
4	T 3303 330						
5	T 3363 330						
5S ²⁾	T 3359 330						
6	T 3403 330						
7	T 3478 330						
7 ²⁾	T 3487 330						
8	T 3507 330						
12							
14							

Assembly instruction³⁾

Panel cutout

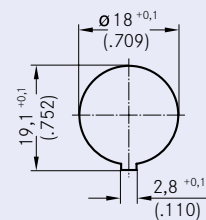
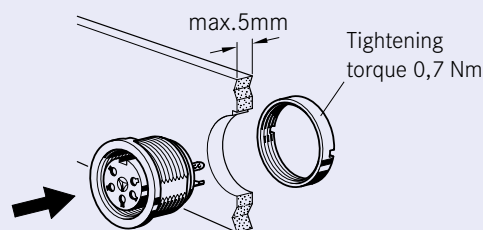







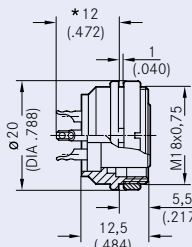

C 091 A Female receptacle | rear mounting

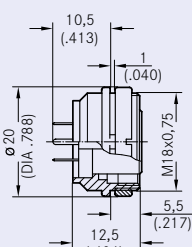
No. of cont.	Part Number solder termination		Part Number crimp termination	Drawing	Figure
	silver plating	gold plating ¹⁾			

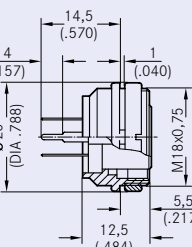
Ring Nut (Hex nut on request)

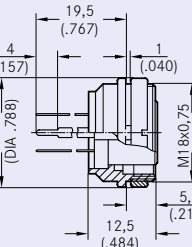
(Please order crimp contacts separately, see page 56)



2	T 3203 100	T 3203 118	T 3203 150	 <p>*Measure 12- and 14-pol.=10±0,3 termination: solder or crimp</p>			
3	T 3263 100	T 3263 118	T 3263 150				
4	T 3303 100	T 3303 118	T 3303 150				
5	T 3363 100	T 3363 118	T 3363 150				
5S ²⁾	T 3359 100	T 3359 118	T 3359 150				
6	T 3403 100	T 3403 118	T 3403 150				
7	T 3478 100	T 3478 118	T 3478 150				
7 ²⁾	T 3487 100	T 3487 118	T 3487 150				
8	T 3507 100	T 3507 118	T 3507 150				
12	T 3638 100	T 3638 118	T 3638 150				
14	T 3653 100	T 3653 118	T 3653 150				
2	T 3203 400	T 3203 404				 <p>pin length 10.5 mm from flange termination: straight dip solder</p>	
3	T 3263 400	T 3263 404					
4	T 3303 400	T 3303 404					
5	T 3363 400	T 3363 404					
5S ²⁾	T 3359 400	T 3359 404					
6	T 3403 400	T 3403 404					
7	T 3478 400	T 3478 404					
7 ²⁾	T 3487 400	T 3487 404					
8	T 3507 400	T 3507 404					
12	T 3638 400	T 3638 404					
14	T 3653 400	T 3653 404					
2		T 3263 420	T 3263 424	 <p>pin length 14.5 mm from flange termination: straight dip solder</p>			
3	T 3263 420	T 3263 424					
4	T 3303 420	T 3303 424					
5	T 3363 420	T 3363 424					
5S ²⁾	T 3359 420	T 3359 424					
6	T 3403 420	T 3403 424					
7	T 3478 420	T 3478 424					
7 ²⁾	T 3487 420	T 3487 424					
8	T 3507 420	T 3507 424					
12	T 3638 420	T 3638 424					
14	T 3653 420	T 3653 424					
2		T 3263 430	T 3263 434			 <p>pin length 19.5 mm from flange termination: straight dip solder</p>	
3	T 3263 430	T 3263 434					
4	T 3303 430	T 3303 434					
5	T 3363 430	T 3363 434					
5S ²⁾	T 3359 430	T 3359 434					
6	T 3403 430	T 3403 434					
7	T 3478 430	T 3478 434					
7 ²⁾	T 3487 430	T 3487 434					
8	T 3507 430	T 3507 434					
12	T 3638 430	T 3638 434					
14	T 3653 430	T 3653 434					

Assembly instruction³⁾

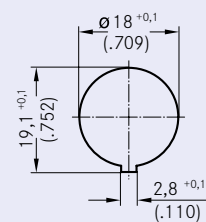
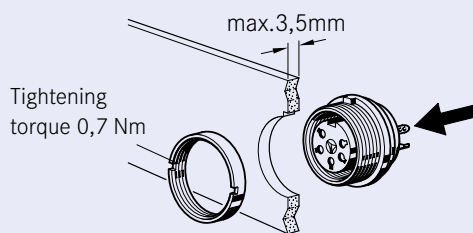

Panel cutout

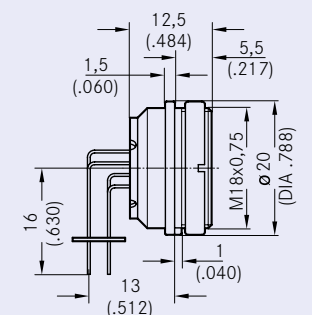

C 091 A Female receptacle | 90° | rear mounting

No. of cont.	Part Number solder termination		Part Number crimp termination	Drawing	Figure
	silver plating	gold plating ¹⁾			
Right-angled Ring Nut (Hex nut on request)			(Please order crimp contacts separately, see page 56)		
2					
3					
4					
5		T 3363 902			
5S ²⁾		T 3403 902			
6					
7					
7 ²⁾					
8					
12					
14					

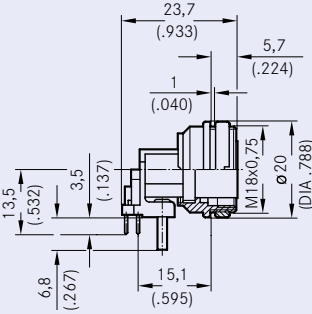
C 091 A Female receptacle | 90° | PCB mounting

No. of cont.	Part Number solder termination		Part Number crimp termination	Drawing	Figure
	silver plating	gold plating ¹⁾			
Right-angled Ring Nut (Hex nut on request)			(Please order crimp contacts separately, see page 56)		
2	T 3263 900				
3					
4					
5					
5S ²⁾	T 3359 900				
6					
7					
7 ²⁾	T 3487 900				
8	T 3507 900	T 3507 918			
12					
14					

Panel cutout ³⁾ | Female receptacle | 90° | rear mounting | PCB mounting

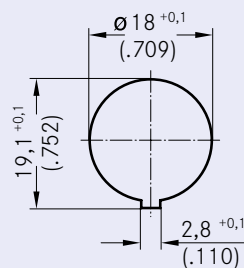

C 091 A Female receptacle | 90° | PCB flange mounting

No. of cont.	Part Number solder termination		Part Number crimp termination	Drawing	Figure
	silver plating	gold plating ¹⁾			

Right-angled

(Please order crimp contacts separately, see page 56)

2					
3					
4					
5		T 3363 218			
5S ²⁾		T 3403 218			
6					
7					
7 ²⁾					
8					
12					
14					

Panel cutout³⁾ | Female receptacle | 90° | PCB flange mounting

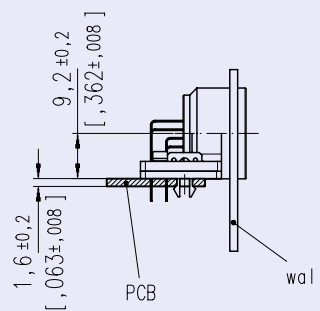
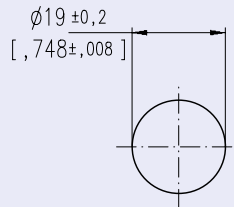

C 091 A Female receptacle | PCB-LAYOUT

PCB-LAYOUT (components side of circuit board)

Female receptacle | front mounting | rear mounting

3 POL

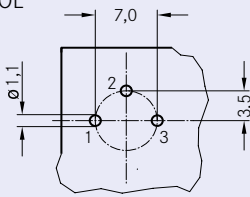

4 POL

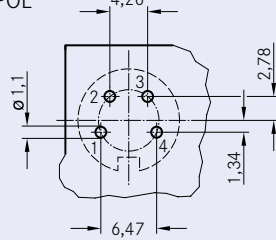

5 POL

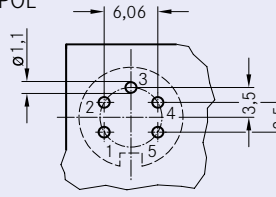

5 POL S¹⁾

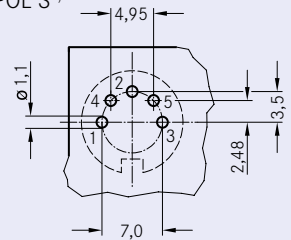

6 POL

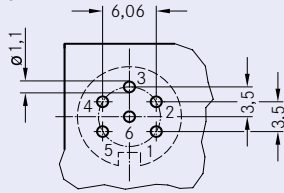

7 POL

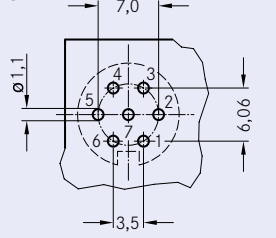

7 POL¹⁾

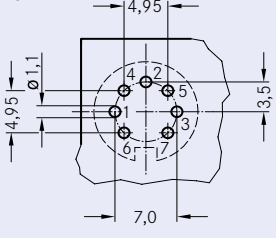

8 POL

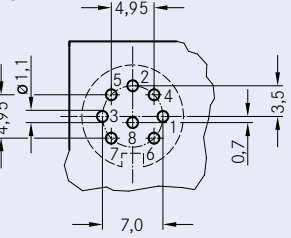

12 POL

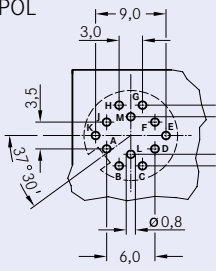

14 POL

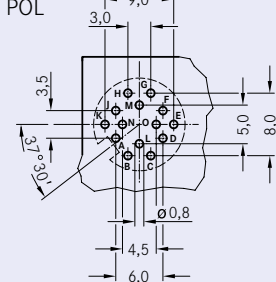

Female receptacle | 90° | rear mounting

5 POL

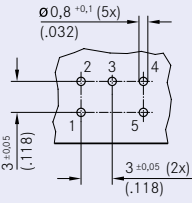

6 POL

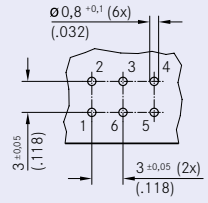

Female receptacle | 90° | PCB mounting

3 POL

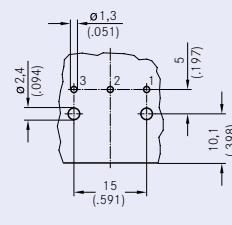

5 POL S¹⁾

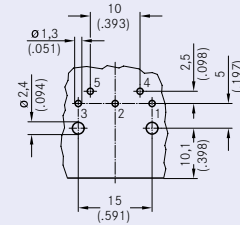

7 POL¹⁾

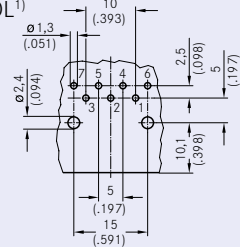

8 POL

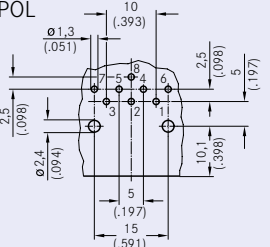

Female receptacle | 90° | PCB flange mounting

5 POL

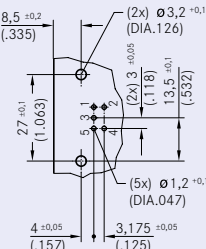

6 POL

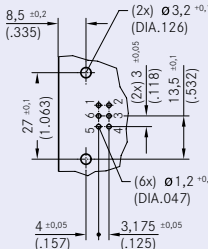



C 091 B

- Bayonet locking
- Plastic locking ring
- 3 - 8, 12 and 14 positions for crimp and solder
- IP 40
- Internal strain relief
- Male and female cable connectors straight and angled
- Male and female receptacles for front and rear panel mounting and PCB mounting
- Coloured back shells optional
- UL registered under file number E 63 093 UL

C 091 B Characteristics

General Characteristics	Standard	Characteristics											
Number of contacts		3	4	5	5 Stereo	6	7	7	8	12	14		
View on termination side of male contact insert													
Contact arrangement	DIN EN 61076-2-106	03-a ✓	04-a ✓	05-a ✓	05-b ✓	06-a ✓	07-a ✓	07-b ✓	08-a ✓	12-a ✓	14-a ✓		
Contact arrangement	IEC 60130-9 ¹⁾	✓	✓		✓	✓		✓	✓				
Electrical Characteristics													
Rated voltage	IEC 60664-1	300 V ≈ (100 V ≈)		300 V ≈ (63 V ≈)		100 V ≈ (32 V ≈)		300 V ≈ (63 V ≈)		100 V ≈ (32 V ≈)		150 V ≈ (32 V ≈)	
Rated voltage	UL 1977	250 V									60 V		
Rated impulse withstand voltage	IEC 60664-1	1500 V (840 V)			1200 V (500 V)		1500 V (840 V)			1200 V (500 V)			
Pollution degree	IEC 60664-1	1 (2)											
Installation category	IEC 60664-1	I											
Insulation group	IEC 60664-1	II, 400 ≤ CTI < 600											
Current rating	IEC 60512-5-2 UL 1977	10 A / + 40 °C			7 A / + 40 °C						3 A / + 40 °C / + 104 °F		
		please refer also to current derating curves page 59											
Insulation resistance	IEC 60512-3-1	> 10 ¹⁰ Ω ²⁾											
Contact resistance	IEC 60512-2-1	< 5 m Ω											
Climatic Characteristics													
Climatic category	IEC 60668-1	40 / 100 / 56											
Temperature range	IEC 60668-1	- 40 °C ... + 100 °C / - 40 °F ... + 212 °F											
Mechanical Characteristics													
IP-degree	IEC 60529	IP 40											
Insertion and withdrawal forces	IEC 60512-13-2	25 N 90.oz	30 N 110.oz	35 N 125.oz	50 N 180.oz	55 N 200.oz	60 N 220.oz	60 N 220.oz	50 N 180.oz				
Mechanical operation	IEC 60512-9-1	Silver ≥ 500 mating cycles Gold ≥ 1000 mating cycles											
Materials													
Housing material		brass or zinc die cast nickel plated or thermoplast											
Dielectric material		thermoplastic											
Contact plating		silver plated / gold plated ³⁾											
Further Characteristics													
Termination technique		solder, crimp											
Wire gauge		solder: ≤ 0,5 mm ² / 20 AWG crimp: 2 - 6 pol (excluding 5S): 0,09 - 1,00 mm ² / 28 - 18 AWG crimp: 5S, 7, 7S and 8-pol.: 0,09 - 0,75 mm ² / 28 - 20 AWG								solder: ≤ 0,25 mm ² / 24 AWG crimp: 0,09-0,25 mm ² / 28 - 24 AWG			
Flammability		UL 94 V0											
Locking system		bayonet											

Caution: Do not connect or disconnect under load. Metal housing parts shall be securely incorporated to protected ground.









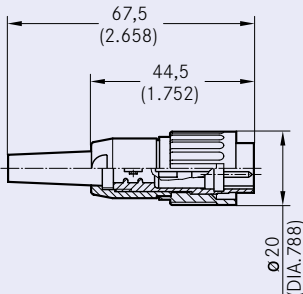

¹⁾ Edition 2000-05

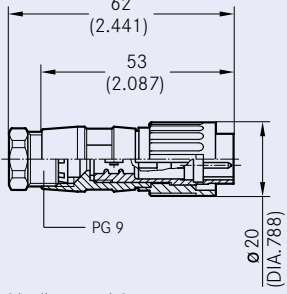
²⁾ Under operating conditions >10⁸ Ω

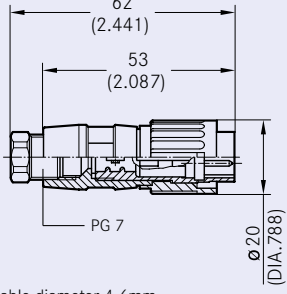
³⁾ Remark for gold plated contacts: In order to avoid brittle inter-metallic connections, gold-plated terminals have to be tin-plated in the solder area.

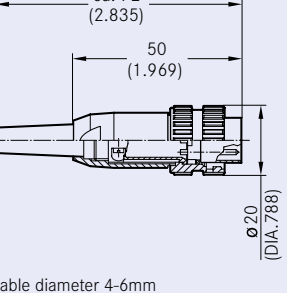
IEC 60 664 ≙ DIN VDE 0110; IEC 60 512-x ≙ DIN EN 60 512-x; IEC 60 130-9 ≙ DIN EN 60 130-9; IEC 61076-2-106 ≙ DIN EN 61076-2-106

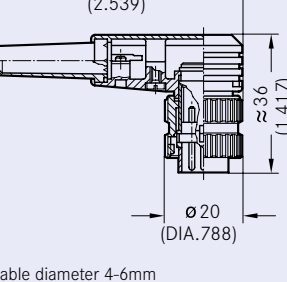
C 091 B Male cable connector | bayonet locking inside (mateable with locking outside)

No. of cont.	Part Number solder termination		Part Number crimp termination	Drawing	Figure		
	silver plating	gold plating ¹⁾					
Locking inside straight (Please order crimp contacts separately, see page 56)							
3	T 3274 501	T 3274 518	T 3274 551	 <p>for cable diameter 4-6mm</p>			
4	T 3324 501	T 3324 518	T 3324 551				
5	T 3374 501	T 3374 518	T 3374 551				
5S ²⁾	T 3394 501	T 3394 518	T 3394 551				
6	T 3424 501	T 3424 518	T 3424 551				
7	T 3434 501	T 3434 518	T 3434 551				
7 ²⁾	T 3444 501	T 3444 518	T 3444 551				
8	T 3524 501	T 3524 518	T 3524 551				
12	T 3624 501	T 3624 518	T 3624 551				
14	T 3644 501	T 3644 518	T 3644 551				
3	T 3274 502	T 3274 528	T 3274 552			 <p>for cable diameter 6-8mm</p>	
4	T 3324 502	T 3324 528	T 3324 552				
5	T 3374 502	T 3374 528	T 3374 552				
5S ²⁾	T 3394 502	T 3394 528	T 3394 552				
6	T 3424 502	T 3424 528	T 3424 552				
7	T 3434 502	T 3434 528	T 3434 552				
7 ²⁾	T 3444 502	T 3444 528	T 3444 552				
8	T 3524 502	T 3524 528	T 3524 552				
12	T 3624 502	T 3624 528	T 3624 552				
14	T 3644 502	T 3644 528	T 3644 552				
3	T 3274 504	T 3274 548	T 3274 554	 <p>for cable diameter 4-6mm</p>			
4	T 3324 504	T 3324 548	T 3324 554				
5	T 3374 504	T 3374 548	T 3374 554				
5S ²⁾	T 3394 504	T 3394 548	T 3394 554				
6	T 3424 504	T 3424 548	T 3424 554				
7	T 3434 504	T 3434 548	T 3434 554				
7 ²⁾	T 3444 504	T 3444 548	T 3444 554				
8	T 3524 504	T 3524 548	T 3524 554				
12	T 3624 504	T 3624 548	T 3624 554				
14	T 3644 504	T 3644 548	T 3644 554				
Locking inside straight full plastic (Please order crimp contacts separately, see page 56)							
3	T 3274 991	T 3274 998	T 3274 951			 <p>for cable diameter 4-6mm</p>	
4	T 3324 991	T 3324 998	T 3324 951				
5	T 3374 991	T 3374 998	T 3374 951				
5S ²⁾	T 3394 991	T 3394 998	T 3394 951				
6	T 3424 991	T 3424 998	T 3424 951				
7	T 3434 991	T 3434 998	T 3434 951				
7 ²⁾			T 3444 951				
8			T 3524 951				
12							
14							
Locking inside right-angled (Please order crimp contacts separately, see page 56)							
3	T 3274 005	T 3274 058	T 3274 055	 <p>for cable diameter 4-6mm</p>			
4	T 3324 005	T 3324 058	T 3324 055				
5	T 3374 005	T 3374 058	T 3374 055				
5S ²⁾	T 3394 005	T 3394 058	T 3394 055				
6	T 3424 005	T 3424 058	T 3424 055				
7	T 3434 005	T 3434 058	T 3434 055				
7 ²⁾	T 3444 005	T 3444 058	T 3444 055				
8	T 3524 005	T 3524 058	T 3524 055				
12	T 3624 005	T 3624 058	T 3624 055				
14	T 3644 005	T 3644 058	T 3644 055				

C 091 B Male cable connector | bayonet locking inside (mateable with locking outside)

Assembly instruction¹⁾, cable diameter 4-6mm

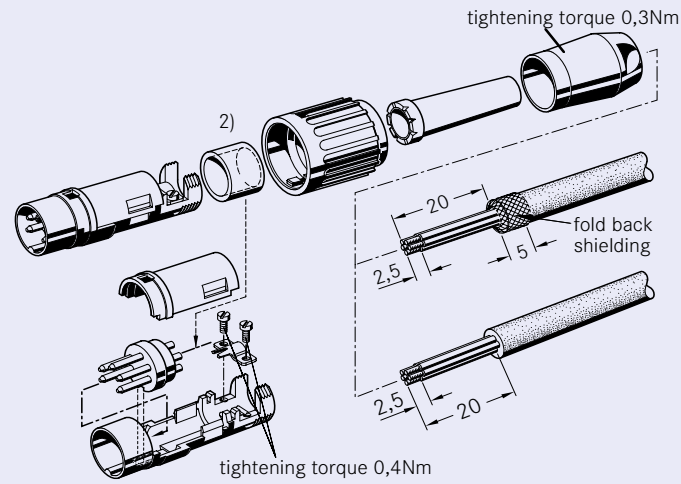

Assembly instruction¹⁾, cable diameter 4-6mm or 6-8mm

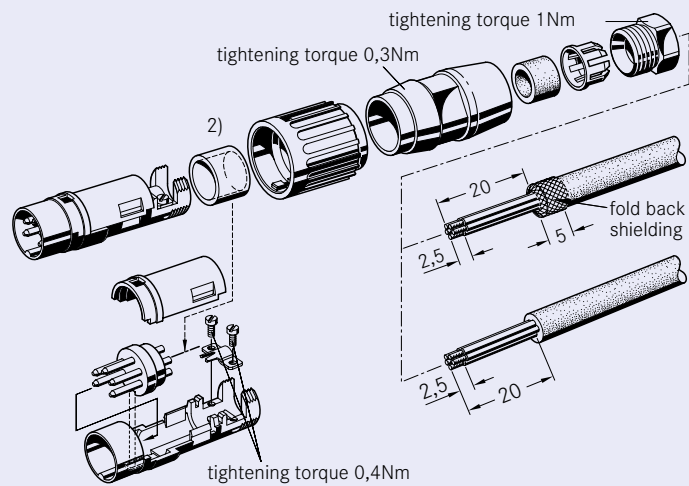

Assembly instruction¹⁾, right-angled, can be keyed to 8 angle positions

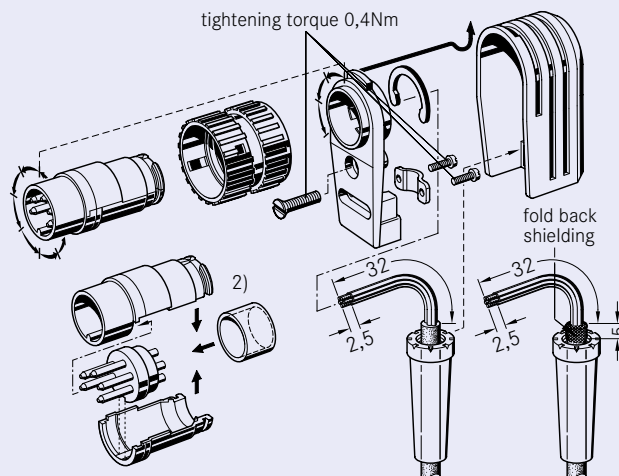

C 091 B Male cable connector | bayonet locking outside (mateable with locking inside)

No. of cont.	Part Number solder termination		Part Number crimp termination	Drawing	Figure		
	silver plating	gold plating ¹⁾					
Locking outside straight (Please order crimp contacts separately, see page 56)							
3	T 3279 501	T 3279 518	T 3279 551	<p>for cable diameter 4-6mm</p>			
4	T 3329 501	T 3329 518	T 3329 551				
5	T 3379 501	T 3379 518	T 3379 551				
5S ²⁾	T 3399 501	T 3399 518	T 3399 551				
6	T 3429 501	T 3429 518	T 3429 551				
7	T 3439 501	T 3439 518	T 3439 551				
7 ²⁾	T 3449 501	T 3449 518	T 3449 551				
8	T 3529 501	T 3529 518	T 3529 551				
12	T 3629 501	T 3629 518	T 3629 551				
14	T 3649 501	T 3649 518	T 3649 551				
3	T 3279 502	T 3279 528	T 3279 552			<p>for cable diameter 6-8mm</p>	
4	T 3329 502	T 3329 528	T 3329 552				
5	T 3379 502	T 3379 528	T 3379 552				
5S ²⁾	T 3399 502	T 3399 528	T 3399 552				
6	T 3429 502	T 3429 528	T 3429 552				
7	T 3439 502	T 3439 528	T 3439 552				
7 ²⁾	T 3449 502	T 3449 528	T 3449 552				
8	T 3529 502	T 3529 528	T 3529 552				
12	T 3629 502	T 3629 528	T 3629 552				
14	T 3649 502	T 3649 528	T 3649 552				
3	T 3279 504	T 3279 548	T 3279 554	<p>for cable diameter 4-6mm</p>			
4	T 3329 504	T 3329 548	T 3329 554				
5	T 3379 504	T 3379 548	T 3379 554				
5S ²⁾	T 3399 504	T 3399 548	T 3399 554				
6	T 3429 504	T 3429 548	T 3429 554				
7	T 3439 504	T 3439 548	T 3439 554				
7 ²⁾	T 3449 504	T 3449 548	T 3449 554				
8	T 3529 504	T 3529 548	T 3529 554				
12	T 3629 504	T 3629 548	T 3629 554				
14	T 3649 504	T 3649 548	T 3649 554				

C 091 B Male cable connector | bayonet locking outside (mateable with locking inside)

Assembly instruction¹⁾, cable diameter 4-6mm

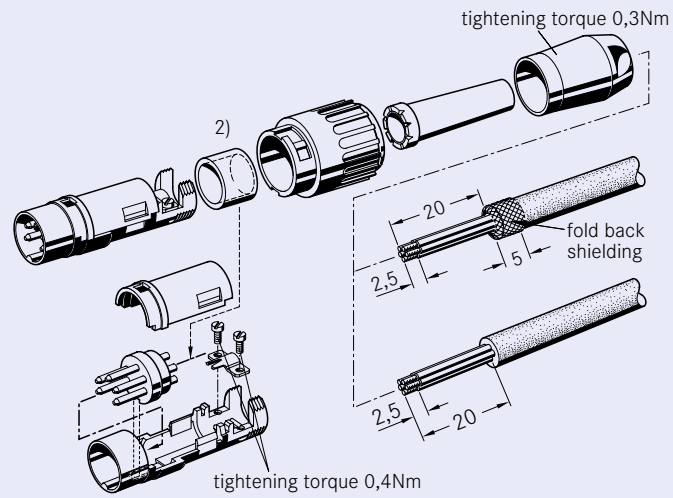

Assembly instruction¹⁾, cable diameter 4-6mm or 6-8mm

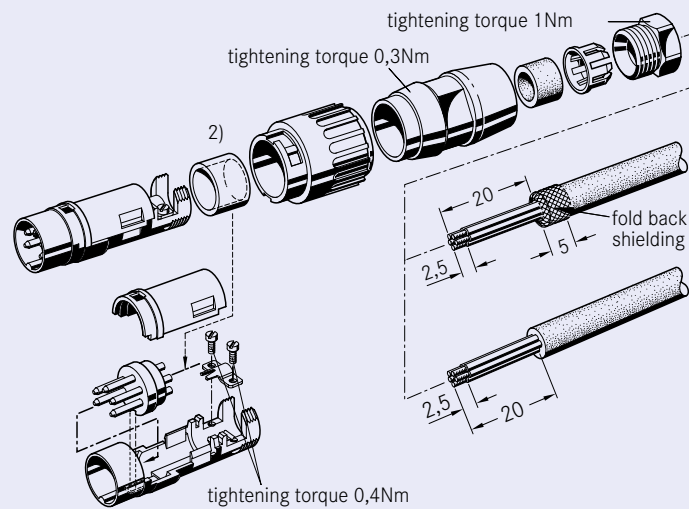

C 091 B Female cable connector | bayonet locking inside (mateable with locking outside)

No. of cont.	Part Number solder termination		Part Number crimp termination	Drawing	Figure
	silver plating	gold plating ¹⁾			
Locking inside straight (Please order crimp contacts separately, see page 56)					
3	T 3275 501	T 3275 518	T 3275 551	<p>for cable diameter 4-6mm</p>	
4	T 3325 501	T 3325 518	T 3325 551		
5	T 3375 501	T 3375 518	T 3375 551		
5S ²⁾	T 3395 501	T 3395 518	T 3395 551		
6	T 3425 501	T 3425 518	T 3425 551		
7	T 3435 501	T 3435 518	T 3435 551		
7 ²⁾	T 3445 501	T 3445 518	T 3445 551		
8	T 3525 501	T 3525 518	T 3525 551		
12	T 3625 501	T 3625 518	T 3625 551		
14	T 3645 501	T 3645 518	T 3645 551		
3	T 3275 502	T 3275 528	T 3275 552	<p>for cable diameter 6-8mm</p>	
4	T 3325 502	T 3325 528	T 3325 552		
5	T 3375 502	T 3375 528	T 3375 552		
5S ²⁾	T 3395 502	T 3395 528	T 3395 552		
6	T 3425 502	T 3425 528	T 3425 552		
7	T 3435 502	T 3435 528	T 3435 552		
7 ²⁾	T 3445 502	T 3445 528	T 3445 552		
8	T 3525 502	T 3525 528	T 3525 552		
12	T 3625 502	T 3625 528	T 3625 552		
14	T 3645 502	T 3645 528	T 3645 552		
3	T 3275 504	T 3275 548	T 3275 554	<p>for cable diameter 4-6mm</p>	
4	T 3325 504	T 3325 548	T 3325 554		
5	T 3375 504	T 3375 548	T 3375 554		
5S ²⁾	T 3395 504	T 3395 548	T 3395 554		
6	T 3425 504	T 3425 548	T 3425 554		
7	T 3435 504	T 3435 548	T 3435 554		
7 ²⁾	T 3445 504	T 3445 548	T 3445 554		
8	T 3525 504	T 3525 548	T 3525 554		
12	T 3625 504	T 3625 548	T 3625 554		
14	T 3645 504	T 3645 548	T 3645 554		
Locking inside straight full plastic (Please order crimp contacts separately, see page 56)					
3	T 3275 991		T 3275 951	<p>for cable diameter 4-6mm</p>	
4	T 3325 991		T 3325 951		
5	T 3375 991		T 3375 951		
5S ²⁾					
6	T 3425 991		T 3425 951		
7	T 3435 991		T 3435 951		
7 ²⁾					
8					
12					
14					
Locking inside right-angled (Please order crimp contacts separately, see page 56)					
3	T 3275 005	T 3275 058	T 3275 055	<p>for cable diameter 4-6mm</p>	
4	T 3325 005	T 3325 058	T 3325 055		
5	T 3375 005	T 3375 058	T 3375 055		
5S ²⁾	T 3395 005	T 3395 058	T 3395 055		
6	T 3425 005	T 3425 058	T 3425 055		
7	T 3435 005	T 3435 058	T 3435 055		
7 ²⁾	T 3445 005	T 3445 058	T 3445 055		
8	T 3525 005	T 3525 058	T 3525 055		
12	T 3625 005	T 3625 058	T 3625 055		
14	T 3645 005	T 3645 058	T 3645 055		

C 091 B Female cable connector | bayonet locking inside (mateable with locking outside)

Assembly instruction¹⁾, cable diameter 4-6mm

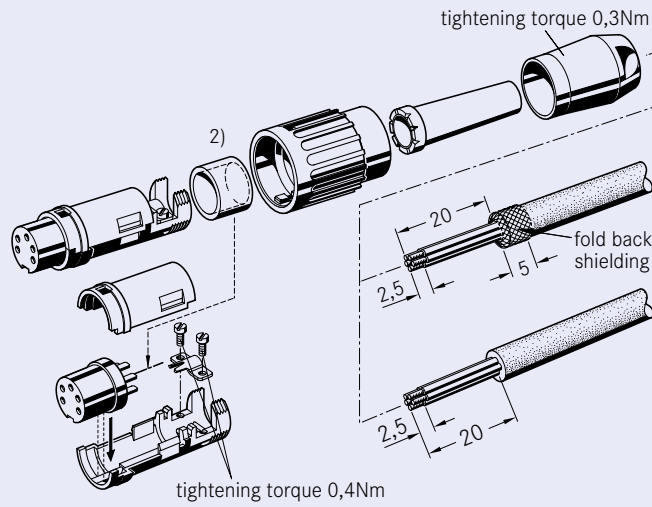



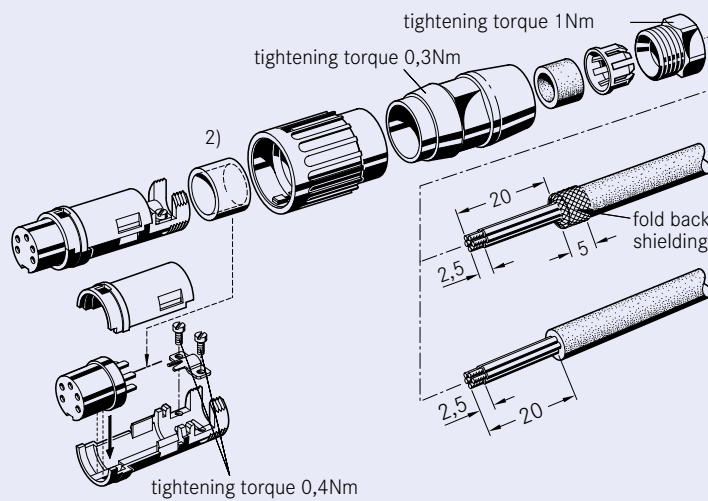



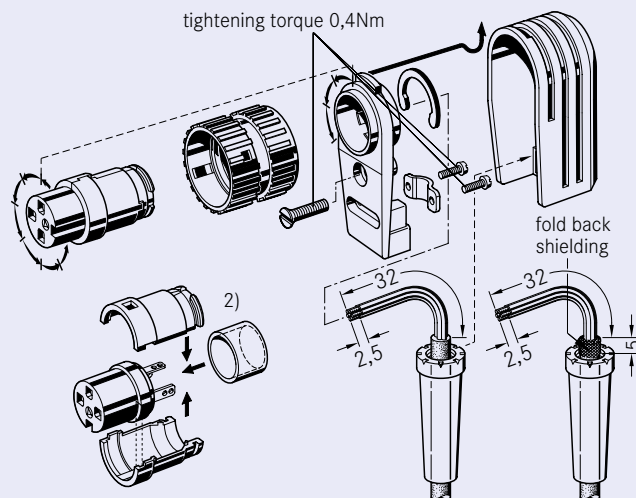

Assembly instruction¹⁾, cable diameter 4-6mm or 6-8mm

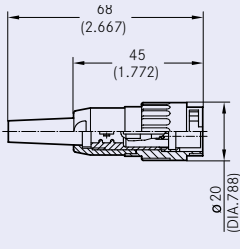

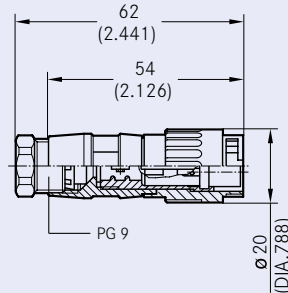
Assembly instruction¹⁾, right-angled, can be keyed to 8 angle positions

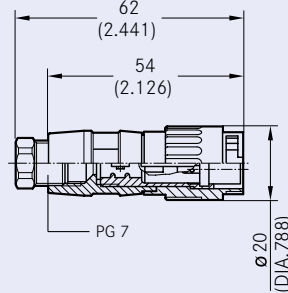

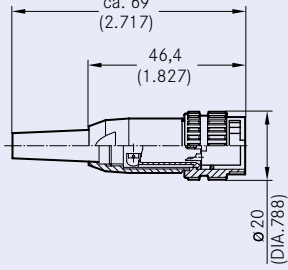
C 091 B Female cable connector | bayonet locking outside (mateable with locking inside)

No. of cont.	Part Number solder termination		Part Number crimp termination	Drawing	Figure		
	silver plating	gold plating ¹⁾					
Locking outside straight (Please order crimp contacts separately, see page 56)							
3	T 3278 501	T 3278 518	T 3278 551	 <p>for cable diameter 4-6mm</p>			
4	T 3328 501	T 3328 518	T 3328 551				
5	T 3378 501	T 3378 518	T 3378 551				
5S ²⁾	T 3398 501	T 3398 518	T 3398 551				
6	T 3428 501	T 3428 518	T 3428 551				
7	T 3438 501	T 3438 518	T 3438 551				
7 ²⁾	T 3448 501	T 3448 518	T 3448 551				
8	T 3528 501	T 3528 518	T 3528 551				
12	T 3628 501	T 3628 518	T 3628 551				
14	T 3648 501	T 3648 518	T 3648 551				
3	T 3278 502	T 3278 528	T 3278 552			 <p>for cable diameter 6-8mm</p>	
4	T 3328 502	T 3328 528	T 3328 552				
5	T 3378 502	T 3378 528	T 3378 552				
5S ²⁾	T 3398 502	T 3398 528	T 3398 552				
6	T 3428 502	T 3428 528	T 3428 552				
7	T 3438 502	T 3438 528	T 3438 552				
7 ²⁾	T 3448 502	T 3448 528	T 3448 552				
8	T 3528 502	T 3528 528	T 3528 552				
12	T 3628 502	T 3628 528	T 3628 552				
14	T 3648 502	T 3648 528	T 3648 552				
3	T 3278 504	T 3278 548	T 3278 554	 <p>for cable diameter 4-6mm</p>			
4	T 3328 504	T 3328 548	T 3328 554				
5	T 3378 504	T 3378 548	T 3378 554				
5S ²⁾	T 3398 504	T 3398 548	T 3398 554				
6	T 3428 504	T 3428 548	T 3428 554				
7	T 3438 504	T 3438 548	T 3438 554				
7 ²⁾	T 3448 504	T 3448 548	T 3448 554				
8	T 3528 504	T 3528 548	T 3528 554				
12	T 3628 504	T 3628 548	T 3628 554				
14	T 3648 504	T 3648 548	T 3648 554				
Locking outside straight full plastic (Please order crimp contacts separately, see page 56)							
3	T 3278 991		T 3278 951			 <p>for cable diameter 4-6mm</p>	
4	T 3328 991		T 3328 951				
5	T 3378 991		T 3378 951				
5S ²⁾							
6	T 3428 991		T 3428 951				
7	T 3438 991		T 3438 951				
7 ²⁾							
8							
12							
14							

C 091 B Female cable connector | bayonet locking outside (mateable with locking inside)

Assembly instruction¹⁾, cable diameter 4-6mm

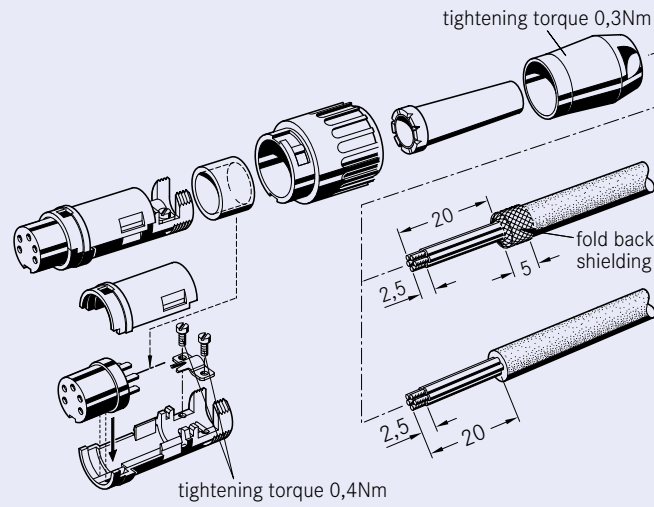

Assembly instruction¹⁾, cable diameter 4-6mm or 6-8mm

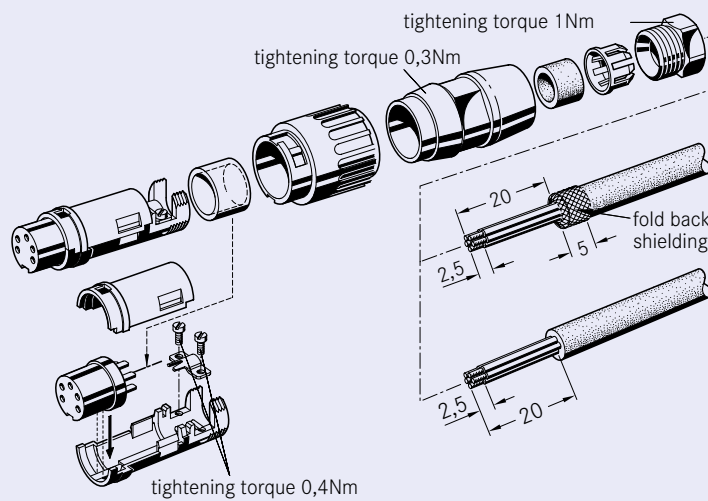

C 091 B Male receptacle | bayonet locking outside (mateable with locking inside) | front mounting | full plastic

No. of cont.	Part Number solder termination		Part Number crimp termination	Drawing	Figure
	silver plating	gold plating ¹⁾			

Locking outside | Snap in

(Please order crimp contacts separately, see page 56)

3	T 3276 500	T 3276 518	T 3276 550
4	T 3326 500	T 3326 518	T 3326 550
5	T 3376 500	T 3376 518	T 3376 550
5S ²⁾	T 3396 500	T 3396 518	T 3396 550
6	T 3426 500	T 3426 518	T 3426 550
7	T 3436 500	T 3436 518	T 3436 550
7 ²⁾	T 3446 500	T 3446 518	T 3446 550
8	T 3526 500	T 3526 518	T 3526 550
12	T 3626 500	T 3626 518	
14	T 3646 500	T 3646 518	

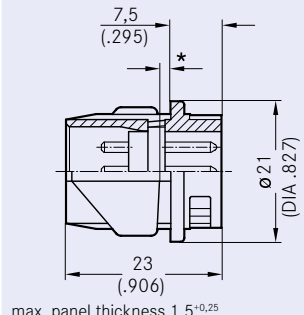

Panel cutout

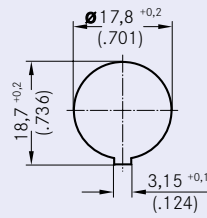

C 091 B Female receptacle | bayonet locking outside (mateable with locking inside) | front mounting | full plastic

No. of cont.	Part Number solder termination		Part Number crimp termination	Drawing	Figure
	silver plating	gold plating ¹⁾			

Locking outside | Ring Nut (Hex nut on request) (Please order crimp contacts separately, see page 56)

3	T 3277 000	T 3277 018	T 3277 050		
4	T 3327 000	T 3327 018	T 3327 050		
5	T 3377 000	T 3377 018	T 3377 050		
5S ²⁾					
6	T 3427 000	T 3427 018	T 3427 050		
7	T 3437 000	T 3437 018	T 3437 050		
7 ²⁾					
8					
12					
14					

Locking outside | Snap in (Please order crimp contacts separately, see page 56)

3	T 3277 500	T 3277 518	T 3277 550		
4	T 3327 500	T 3327 518	T 3327 550		
5	T 3377 500	T 3377 518	T 3377 550		
5S ²⁾	T 3397 500	T 3397 518	T 3397 550		
6	T 3427 500	T 3427 518	T 3427 550		
7	T 3437 500	T 3437 518	T 3437 550		
7 ²⁾	T 3447 500	T 3447 518	T 3447 550		
8	T 3527 500	T 3527 518			
12	T 3627 500	T 3627 518			
14	T 3647 500	T 3647 518			

Locking inside | Snap in (Please order crimp contacts separately, see page 56)

3	T 3271 500	T 3271 518	T 3271 550		
4	T 3321 500	T 3321 518	T 3321 550		
5	T 3371 500	T 3371 518	T 3371 550		
5S ²⁾	T 3391 500	T 3391 518	T 3391 550		
6	T 3421 500	T 3421 518	T 3421 550		
7	T 3431 500	T 3431 518	T 3431 550		
7 ²⁾	T 3441 500	T 3441 518	T 3441 550		
8	T 3521 500	T 3521 518	T 3521 550		
12	T 3621 500	T 3621 518			
14	T 3641 500	T 3641 518			

Panel cutout

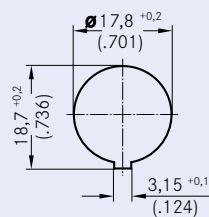

C 091 B Female receptacle | bayonet locking outside (mateable with locking inside) | rear mounting | metal

No. of cont.	Part Number solder termination		Part Number crimp termination	Drawing	Figure
	silver plating	gold plating ¹⁾			

Locking outside | Ring Nut (Hex nut on request) (Please order crimp contacts separately, see page 56)

3	T 3277 100	T 3277 118	T 3277 150
4	T 3327 100	T 3327 118	T 3327 150
5	T 3377 100	T 3377 118	T 3377 150
5S ²⁾	T 3397 100	T 3397 118	T 3397 150
6	T 3427 100	T 3427 118	T 3427 150
7	T 3437 100	T 3437 118	T 3437 150
7 ²⁾	T 3447 100	T 3447 118	T 3447 150
8	T 3527 100	T 3527 118	T 3527 150
12	T 3627 100	T 3627 118	
14	T 3647 100	T 3647 118	

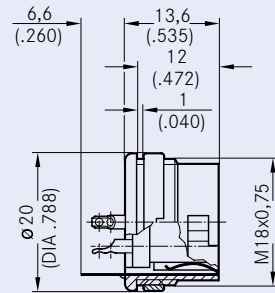

Panel cutout

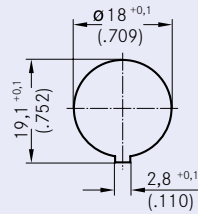

C 091 B Female receptacle | bayonet locking outside (mateable with locking inside) | 90° | PCB mounting

No. of cont.	Part Number		Part Number crimp termination	Drawing	Figure
	silver plating	gold plating ¹⁾			
Locking outside (Please order crimp contacts separately, see page 56)					
3 4 5 5S ²⁾ 6 7 7 ²⁾ 8 12 14	T 3277 600 T 3377 600 T 3397 600 T 3427 600				
3 4 5 5S ²⁾ 6 7 7 ²⁾ 8 12 14	T 3277 900 T 3397 900 T 3447 900 T 3527 900				

Position when mounted directly next to another

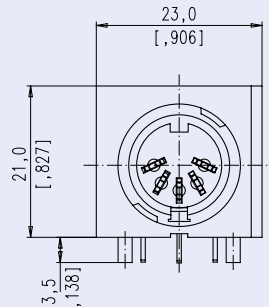

C 091 B Female receptacle | PCB-Layout

PCB-Layout (components side of circuit board)

Female receptacle | bayonet locking outside (mateable with locking inside) | 90° | PCB mounting

3 POL

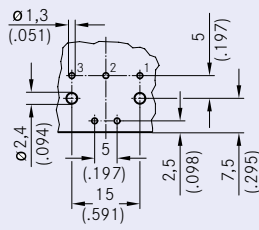

5 POL

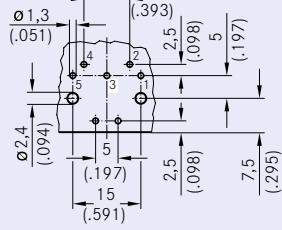

5 POL Stereo

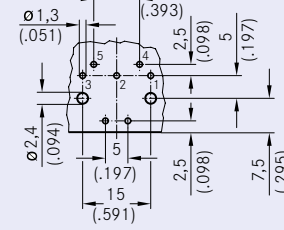

6 POL

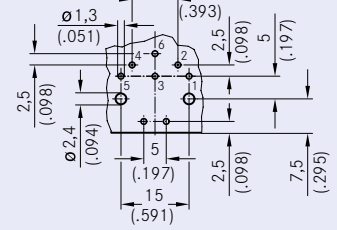

7 POL

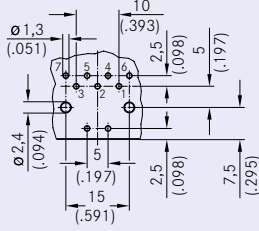

8 POL

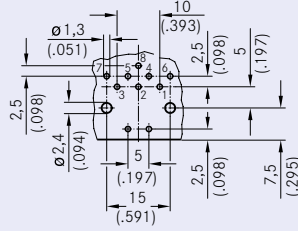



C 091 D

- **M16 size**
- **Screw locking according to IEC 61076-2-106**
- **Metal locking ring**
- **Shieldable**
- **3 - 8, 12 and 14 positions for crimp and solder**
- **IP 69 K / IP 67 / IP 65**
- **Internal strain relief**
- **Male and female cable connectors straight and angled**
- **Male and female receptacles for front and rear panel mounting and PCB mounting**
- **UL registered under file number E 63 093 UL**
- **Connectors are compliant with AISG-standard**

C 091 D Characteristics

General Characteristics	Standard	Characteristics										
Number of contacts		3	4	5	5 Stereo	6	7	7	8	12	14	
View on termination side of male contact insert												
Contact arrangement	DIN EN 61076-2-106	03-a ✓	04-a ✓	05-a ✓	05-b ✓	06-a ✓	07-a ✓	07-b ✓	08-a ✓	12-a ✓	14-a ✓	
Contact arrangement	IEC 60130-9 ¹⁾	✓	✓		✓	✓		✓	✓			
Electrical Characteristics												
Rated voltage ²⁾	IEC 60664-1	300 V ≈ (100 V ≈)		300 V ≈ (63 V ≈)		100 V ≈ (32 V ≈)		300 V ≈ (63 V ≈)		100 V ≈ (32 V ≈)		150 V ≈ (32 V ≈)
Rated voltage	UL 1977	250 V								60 V		
Rated impulse withstand voltage ²⁾	IEC 60664-1	1500 V (840 V)			1200 V (500 V)		1500 V (840 V)			1200 V (500 V)		
Pollution degree ²⁾	IEC 60664-1	1 (3 ³⁾)										
Installation category	IEC 60664-1	I										
Insulation group	IEC 60664-1	II, 400 ≤ CTI < 600										
Current rating	IEC 60512-5-2 UL 1977	10 A / + 40 °C				7 A / + 40 °C					3 A / + 40 °C / + 104 °F	
		please refer also to current derating curves page 59										
Insulation resistance	IEC 60512-3-1	> 10 ¹⁰ Ω ⁴⁾										
Contact resistance	IEC 60512-2-1	< 5 m Ω										
Climatic Characteristics												
Climatic category	IEC 60668-1	40 / 100 / 56										
Temperature range	IEC 60668-1	- 40 °C ... + 100 °C / - 40 °F ... + 212 °F										
Salt Spray Resistance	DIN IEC 60068-2-11, Test Ka	720h										
Mechanical Characteristics												
IP-degree	IEC 60529	IP 69K / IP 67 / IP 65 (in mated condition)										
Insertion and withdrawal forces	IEC 60512-13-2	25 N 90.oz	30 N 110.oz	35 N 125.oz	50 N 180.oz	55 N 200.oz	60 N 220.oz	50 N 180.oz				
Mechanical operation	IEC 60512-9-1	Silver ≥ 500 mating cycles Gold ≥ 1000 mating cycles										
Materials												
Housing material		brass or zinc die cast nickel plated or thermoplast										
Dielectric material		thermoplastic										
Contact plating		silver plated / gold plated ⁵⁾										
Further Characteristics												
Termination technique		solder, crimp										
Wire gauge		solder: ≤ 0,5 mm ² / 20 AWG crimp: 2 - 6 pol (excluding 5S): 0,09 - 1,00 mm ² / 28 - 18 AWG crimp: 5S, 7, 7S and 8-pol.: 0,09 - 0,75 mm ² / 28 - 20 AWG								solder: ≤ 0,25 mm ² / 24 AWG crimp: 0,09-0,25 mm ² / 28 - 24 AWG		
Flammability		UL 94 V0										
Locking system	IEC 60130-9 DIN EN 61076-2-106	metal screw coupling; tightening torque 1,0 - 1,5 Nm										
UL	UL 1977	Conditions of acceptability										

Caution: Do not connect or disconnect under load. Metal housing parts shall be securely incorporated to protected ground.

¹⁾ Edition 2000-05

²⁾ Values in brackets are according to DIN EN 61076-2-106







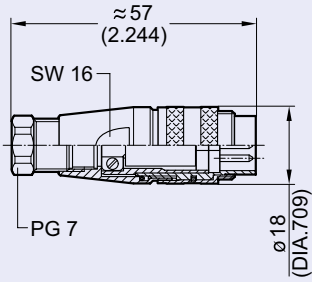

³⁾ Designed acc. pollution degree 2; can be used under pollution degree 3 when the rules of IEC 60644-1 are fulfilled

⁴⁾ Under operating conditions >10⁸ Ω

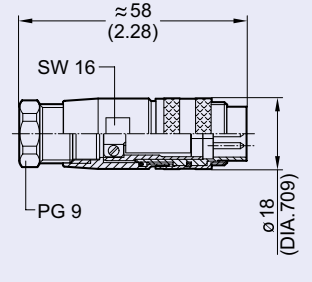
⁵⁾ Remark for gold plated contacts: In order to avoid brittle inter-metallic connections, gold-plated terminals have to be tin-plated in the solder area.

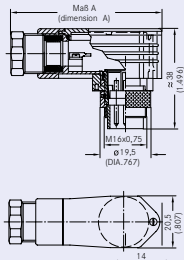
IEC 60 664 ≙ DIN VDE 0110 ; IEC 60 512-x ≙ DIN EN 60 512-x; IEC 60 130-9 ≙ DIN EN 60 130-9; IEC 61076-2-106 ≙ DIN EN 61076-2-106

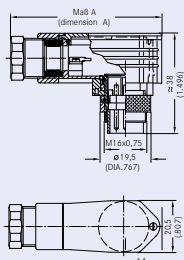
C 091 D Male cable connector

No. of cont.	Part Number		Part Number crimp termination	Drawing	Figure		
	solder termination silver plating	gold plating ¹⁾					
Straight (Please order crimp contacts separately, see page 56)							
3	C091 31H003 100 2	C091 31H003 200 2	C091 11H003 000 2	 <p>for cable diameter 4-6mm</p>			
4	C091 31H004 100 2	C091 31H004 200 2	C091 11H004 000 2				
5	C091 31H005 100 2	C091 31H005 200 2	C091 11H005 000 2				
5S ²⁾	C091 31H105 100 2	C091 31H105 200 2	C091 11H105 000 2				
6	C091 31H006 100 2	C091 31H006 200 2	C091 11H006 000 2				
7	C091 31H007 100 2	C091 31H007 200 2	C091 11H007 000 2				
7 ²⁾	C091 31H107 100 2	C091 31H107 200 2	C091 11H107 000 2				
8	C091 31H008 100 2	C091 31H008 200 2	C091 11H008 000 2				
12	C091 31H012 100 2	C091 31H012 200 2	C091 11H012 000 2				
14	C091 31H014 100 2	C091 31H014 200 2	C091 11H014 000 2				
3	C091 31H003 101 2	C091 31H003 201 2	C091 11H003 001 2			 <p>for cable diameter 6-8mm</p>	
4	C091 31H004 101 2	C091 31H004 201 2	C091 11H004 001 2				
5	C091 31H005 101 2	C091 31H005 201 2	C091 11H005 001 2				
5S ²⁾	C091 31H105 101 2	C091 31H105 201 2	C091 11H105 001 2				
6	C091 31H006 101 2	C091 31H006 201 2	C091 11H006 001 2				
7	C091 31H007 101 2	C091 31H007 201 2	C091 11H007 001 2				
7 ²⁾	C091 31H107 101 2	C091 31H107 201 2	C091 11H107 001 2				
8	C091 31H008 101 2	C091 31H008 201 2	C091 11H008 001 2				
12	C091 31H012 101 2	C091 31H012 201 2	C091 11H012 001 2				
14	C091 31H014 101 2	C091 31H014 201 2	C091 11H014 001 2				
Right-angled (Please order crimp contacts separately, see page 56)							
3	C091 31K003 100 2	C091 31K003 200 2	C091 11K003 000 2	 <p>for cable diameter 4-6mm Dimension A = 55,5 mm</p>			
4	C091 31K004 100 2	C091 31K004 200 2	C091 11K004 000 2				
5	C091 31K005 100 2	C091 31K005 200 2	C091 11K005 000 2				
5S ²⁾	C091 31K105 100 2	C091 31K105 200 2	C091 11K105 000 2				
6	C091 31K006 100 2	C091 31K006 200 2	C091 11K006 000 2				
7	C091 31K007 100 2	C091 31K007 200 2	C091 11K007 000 2				
7 ²⁾	C091 31K107 100 2	C091 31K107 200 2	C091 11K107 000 2				
8	C091 31K008 100 2	C091 31K008 200 2	C091 11K008 000 2				
12	C091 31K012 100 2	C091 31K012 200 2	C091 11K012 000 2				
14	C091 31K014 100 2	C091 31K014 200 2	C091 11K014 000 2				
3	C091 31K003 101 2	C091 31K003 201 2	C091 11K003 001 2			 <p>for cable diameter 6-8mm Dimension A = 57,5 mm</p>	
4	C091 31K004 101 2	C091 31K004 201 2	C091 11K004 001 2				
5	C091 31K005 101 2	C091 31K005 201 2	C091 11K005 001 2				
5S ²⁾	C091 31K105 101 2	C091 31K105 201 2	C091 11K105 001 2				
6	C091 31K006 101 2	C091 31K006 201 2	C091 11K006 001 2				
7	C091 31K007 101 2	C091 31K007 201 2	C091 11K007 001 2				
7 ²⁾	C091 31K107 101 2	C091 31K107 201 2	C091 11K107 001 2				
8	C091 31K008 101 2	C091 31K008 201 2	C091 11K008 001 2				
12	C091 31K012 101 2	C091 31K012 201 2	C091 11K012 001 2				
14	C091 31K014 101 2	C091 31K014 201 2	C091 11K014 001 2				

C 091 D Male cable connector



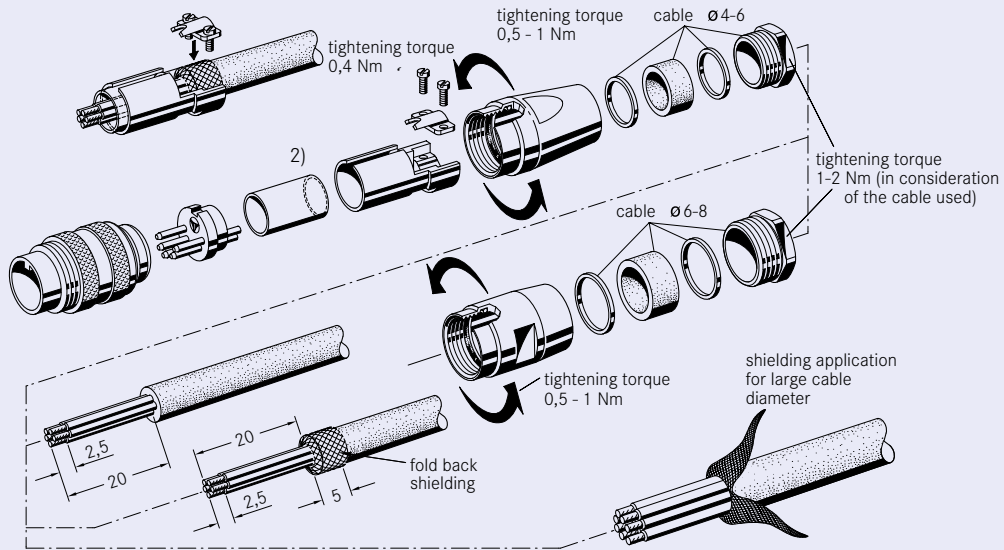



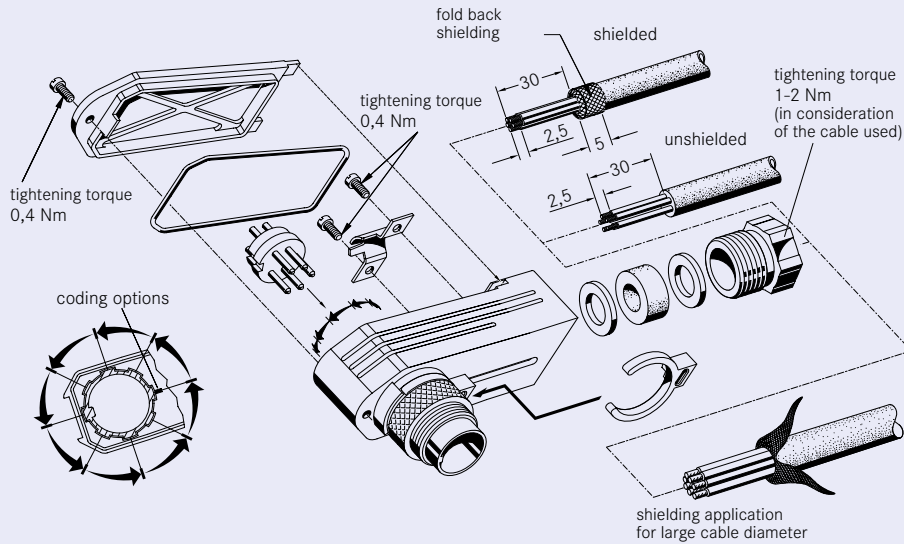

Assembly instruction¹⁾

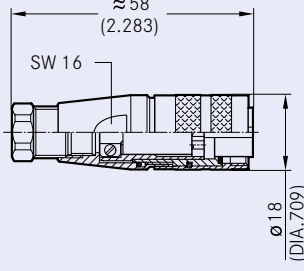

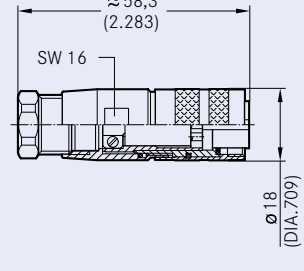
Assembly instruction¹⁾, can be keyed to 8 angle positions

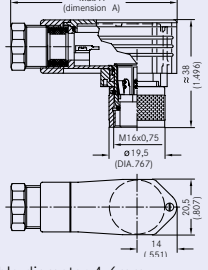

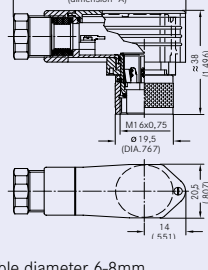
C 091 D Female cable connector

No. of cont.	Part Number solder termination		Part Number crimp termination	Drawing	Figure		
	silver plating	gold plating ¹⁾					
Straight (Please order crimp contacts separately, see page 56)							
3	C091 31D003 100 2	C091 31D003 200 2	C091 11D003 000 2	 <p>for cable diameter 4-6mm</p>			
4	C091 31D004 100 2	C091 31D004 200 2	C091 11D004 000 2				
5	C091 31D005 100 2	C091 31D005 200 2	C091 11D005 000 2				
5S ²⁾	C091 31D105 100 2	C091 31D105 200 2	C091 11D105 000 2				
6	C091 31D006 100 2	C091 31D006 200 2	C091 11D006 000 2				
7	C091 31D007 100 2	C091 31D007 200 2	C091 11D007 000 2				
7 ²⁾	C091 31D107 100 2	C091 31D107 200 2	C091 11D107 000 2				
8	C091 31D008 100 2	C091 31D008 200 2	C091 11D008 000 2				
12	C091 31D012 100 2	C091 31D012 200 2	C091 11D012 000 2				
14	C091 31D014 100 2	C091 31D014 200 2	C091 11D014 000 2				
3	C091 31D003 101 2	C091 31D003 201 2	C091 11D003 001 2			 <p>for cable diameter 6-8mm</p>	
4	C091 31D004 101 2	C091 31D004 201 2	C091 11D004 001 2				
5	C091 31D005 101 2	C091 31D005 201 2	C091 11D005 001 2				
5S ²⁾	C091 31D105 101 2	C091 31D105 201 2	C091 11D105 001 2				
6	C091 31D006 101 2	C091 31D006 201 2	C091 11D006 001 2				
7	C091 31D007 101 2	C091 31D007 201 2	C091 11D007 001 2				
7 ²⁾	C091 31D107 101 2	C091 31D107 201 2	C091 11D107 001 2				
8	C091 31D008 101 2	C091 31D008 201 2	C091 11D008 001 2				
12	C091 31D012 101 2	C091 31D012 201 2	C091 11D012 001 2				
14	C091 31D014 101 2	C091 31D014 201 2	C091 11D014 001 2				
Right-angled (Please order crimp contacts separately, see page 56)							
3	C091 31F003 100 2	C091 31F003 200 2	C091 11F003 000 2	 <p>for cable diameter 4-6mm Dimension A = 55,5 mm</p>			
4	C091 31F004 100 2	C091 31F004 200 2	C091 11F004 000 2				
5	C091 31F005 100 2	C091 31F005 200 2	C091 11F005 000 2				
5S ²⁾	C091 31F105 100 2	C091 31F105 200 2	C091 11F105 000 2				
6	C091 31F006 100 2	C091 31F006 200 2	C091 11F006 000 2				
7	C091 31F007 100 2	C091 31F007 200 2	C091 11F007 000 2				
7 ²⁾	C091 31F107 100 2	C091 31F107 200 2	C091 11F107 000 2				
8	C091 31F008 100 2	C091 31F008 200 2	C091 11F008 000 2				
12	C091 31F012 100 2	C091 31F012 200 2	C091 11F012 000 2				
14	C091 31F014 100 2	C091 31F014 200 2	C091 11F014 000 2				
3	C091 31F003 101 2	C091 31F003 201 2	C091 11F003 001 2			 <p>for cable diameter 6-8mm Dimension A = 57,5 mm</p>	
4	C091 31F004 101 2	C091 31F004 201 2	C091 11F004 001 2				
5	C091 31F005 101 2	C091 31F005 201 2	C091 11F005 001 2				
5S ²⁾	C091 31F105 101 2	C091 31F105 201 2	C091 11F105 001 2				
6	C091 31F006 101 2	C091 31F006 201 2	C091 11F006 001 2				
7	C091 31F007 101 2	C091 31F007 201 2	C091 11F007 001 2				
7 ²⁾	C091 31F107 101 2	C091 31F107 201 2	C091 11F107 001 2				
8	C091 31F008 101 2	C091 31F008 201 2	C091 11F008 001 2				
12	C091 31F012 101 2	C091 31F012 201 2	C091 11F012 001 2				
14	C091 31F014 101 2	C091 31F014 201 2	C091 11F014 001 2				

¹⁾ See remark page 41

²⁾ Contact arrangement acc. to DIN EN 61076-2-106 "0X-b"

C 091 D Female cable connector

Assembly instruction¹⁾

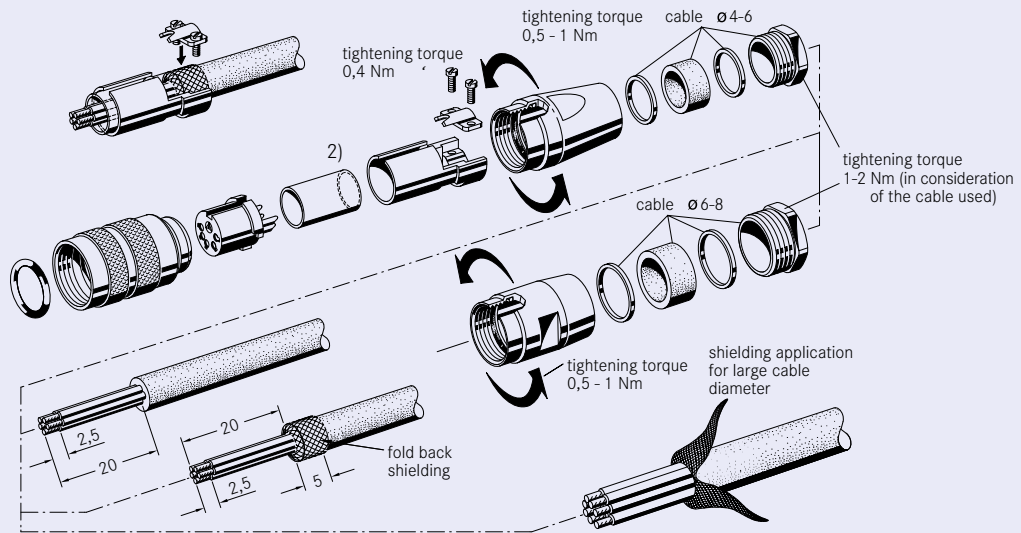

Assembly instruction¹⁾, can be keyed to 8 angle positions

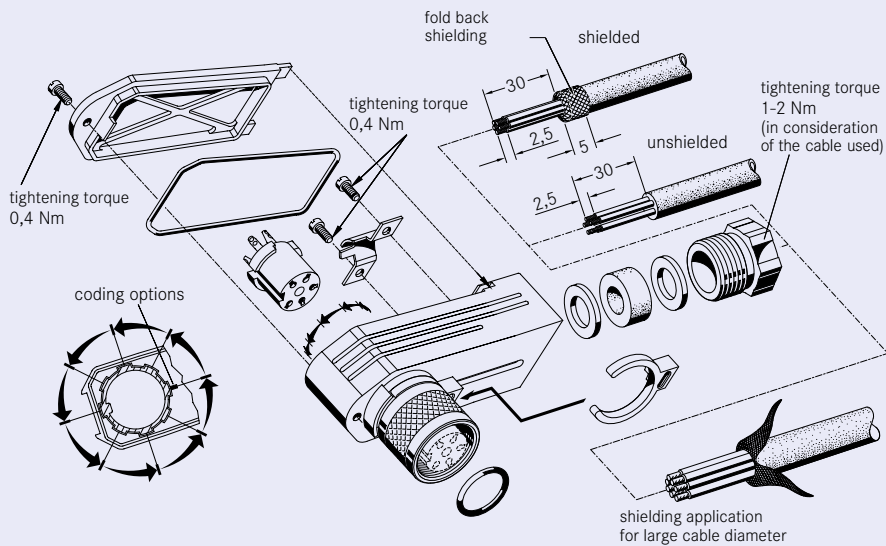

C 091 D Male receptacle | front mounting

No. of cont.	Part Number solder termination		Part Number crimp termination	Drawing	Figure
	silver plating	gold plating ¹⁾			
Ring Nut (Hex nut on request)			(Please order crimp contacts separately, see page 56)		
3	C091 31W003 100 2	C091 31W003 200 2	C091 11W003 000 2		
4	C091 31W004 100 2	C091 31W004 200 2	C091 11W004 000 2		
5	C091 31W005 100 2	C091 31W005 200 2	C091 11W005 000 2		
5S ²⁾	C091 31W105 100 2	C091 31W105 200 2	C091 11W105 000 2		
6	C091 31W006 100 2	C091 31W006 200 2	C091 11W006 000 2		
7	C091 31W007 100 2	C091 31W007 200 2	C091 11W007 000 2		
7 ²⁾	C091 31W107 100 2	C091 31W107 200 2	C091 11W107 000 2		
8	C091 31W008 100 2	C091 31W008 200 2	C091 11W008 000 2		
12	C091 31W012 100 2	C091 31W012 200 2	C091 11W012 000 2		
14	C091 31W014 100 2	C091 31W014 200 2	C091 11W014 000 2		

Assembly instruction

Panel cutout

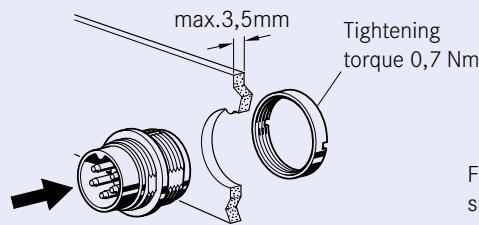

For sealing reasons the surface for the gasket needs to be level and free of burrs.

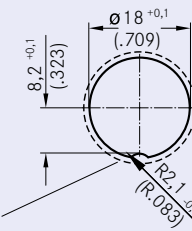

C 091 D Male receptacle | rear mounting

No. of cont.	Part Number solder termination		Part Number crimp termination	Drawing	Figure
	silver plating	gold plating ¹⁾			
Ring Nut (Hex nut on request)			(Please order crimp contacts separately, see page 56)		
3	C091 31C003 100 2	C091 31C003 200 2	C091 11C003 000 2		
4	C091 31C004 100 2	C091 31C004 200 2	C091 11C004 000 2		
5	C091 31C005 100 2	C091 31C005 200 2	C091 11C005 000 2		
5S ²⁾	C091 31C105 100 2	C091 31C105 200 2	C091 11C105 000 2		
6	C091 31C006 100 2	C091 31C006 200 2	C091 11C006 000 2		
7	C091 31C007 100 2	C091 31C007 200 2	C091 11C007 000 2		
7 ²⁾	C091 31C107 100 2	C091 31C107 200 2	C091 11C107 000 2		
8	C091 31C008 100 2	C091 31C008 200 2	C091 11C008 000 2		
12	C091 31C012 100 2	C091 31C012 200 2	C091 11C012 000 2		
14	C091 31C014 100 2	C091 31C014 200 2	C091 11C014 000 2		

Assembly instruction

Panel cutout

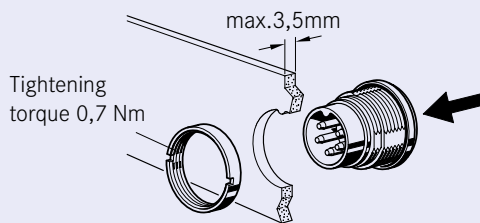

For sealing reasons the surface for the gasket needs to be level and free of burrs.

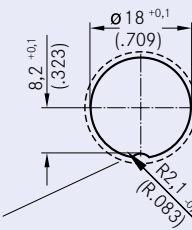

C 091 D Male receptacle | flange mounting

No. of cont.	Part Number solder termination		Part Number crimp termination	Drawing	Figure
	silver plating	gold plating ¹⁾			

Ring Nut (for hex nut see page 57)

(Please order crimp contacts separately, see page 56)

3	C091 31S003 100 2	C091 31S003 200 2	C091 11S003 000 2
4	C091 31S004 100 2	C091 31S004 200 2	C091 11S004 000 2
5	C091 31S005 100 2	C091 31S005 200 2	C091 11S005 000 2
5S ²⁾	C091 31S105 100 2	C091 31S105 200 2	C091 11S105 000 2
6	C091 31S006 100 2	C091 31S006 200 2	C091 11S006 000 2
7	C091 31S007 100 2	C091 31S007 200 2	C091 11S007 000 2
7 ²⁾	C091 31S107 100 2	C091 31S107 200 2	C091 11S107 000 2
8	C091 31S008 100 2	C091 31S008 200 2	C091 11S008 000 2
12	C091 31S012 100 2	C091 31S012 200 2	C091 11S012 000 2
14	C091 31S014 100 2	C091 31S014 200 2	C091 11S014 000 2

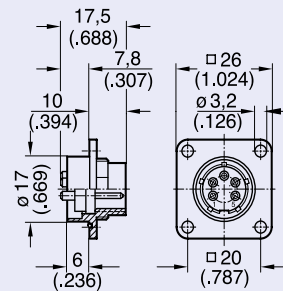

Panel cutout

For sealing reasons the surface for the gasket needs to be level and free of burrs. Provide suitable sealing for the screws.

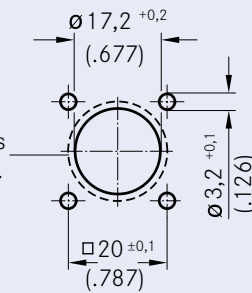

C 091 D Female receptacle | front mounting

No. of cont.	Part Number solder termination		Part Number crimp termination	Drawing	Figure		
	silver plating	gold plating ¹⁾					
Ring Nut (Hex nut on request)			(Please order crimp contacts separately, see page 56)				
3	C091 31N003 100 2	C091 31N003 200 2	C091 11N003 000 2				
4	C091 31N004 100 2	C091 31N004 200 2	C091 11N004 000 2				
5	C091 31N005 100 2	C091 31N005 200 2	C091 11N005 000 2				
5S ²⁾	C091 31N105 100 2	C091 31N105 200 2	C091 11N105 000 2				
6	C091 31N006 100 2	C091 31N006 200 2	C091 11N006 000 2				
7	C091 31N007 100 2	C091 31N007 200 2	C091 11N007 000 2				
7 ²⁾	C091 31N107 100 2	C091 31N107 200 2	C091 11N107 000 2				
8	C091 31N008 100 2	C091 31N008 200 2	C091 11N008 000 2				
12	C091 31N012 100 2	C091 31N012 200 2	C091 11N012 000 2				
14	C091 31N014 100 2	C091 31N014 200 2	C091 11N014 000 2				
3	C091 61N003 110 2	C091 61N003 210 2					
4	C091 61N004 110 2	C091 61N004 210 2					
5	C091 61N005 110 2	C091 61N005 210 2					
5S ²⁾	C091 61N105 110 2	C091 61N105 210 2					
6	C091 61N006 110 2	C091 61N006 210 2					
7	C091 61N007 110 2	C091 61N007 210 2					
7 ²⁾	C091 61N107 110 2	C091 61N107 210 2					
8	C091 61N008 110 2	C091 61N008 210 2					
12	C091 61N012 110 2	C091 61N012 210 2					
14	C091 61N014 110 2	C091 61N014 210 2					
3	C091 61N003 120 2	C091 61N003 220 2					
4	C091 61N004 120 2	C091 61N004 220 2					
5	C091 61N005 120 2	C091 61N005 220 2					
5S ²⁾	C091 61N105 120 2	C091 61N105 220 2					
6	C091 61N006 120 2	C091 61N006 220 2					
7	C091 61N007 120 2	C091 61N007 220 2					
7 ²⁾	C091 61N107 120 2	C091 61N107 220 2					
8	C091 61N008 120 2	C091 61N008 220 2					
12	C091 61N012 120 2	C091 61N012 220 2					
14	C091 61N014 120 2	C091 61N014 220 2					
3	C091 61N003 130 2	C091 61N003 230 2					
4	C091 61N004 130 2	C091 61N004 230 2					
5	C091 61N005 130 2	C091 61N005 230 2					
5S ²⁾	C091 61N105 130 2	C091 61N105 230 2					
6	C091 61N006 130 2	C091 61N006 230 2					
7	C091 61N007 130 2	C091 61N007 230 2					
7 ²⁾	C091 61N107 130 2	C091 61N107 230 2					
8	C091 61N008 130 2	C091 61N008 230 2					
12	C091 61N012 130 2	C091 61N012 230 2					
14	C091 61N014 130 2	C091 61N014 230 2					

Assembly instruction³⁾

Panel cutout

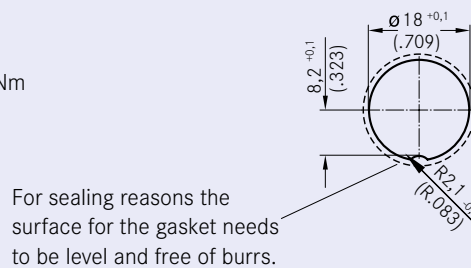
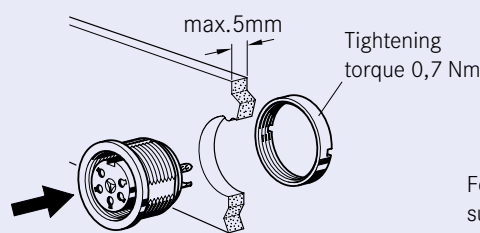

C 091 D Female receptacle | rear mounting

No. of cont.	Part Number solder termination		Part Number crimp termination	Drawing	Figure		
	silver plating	gold plating ¹⁾					
Ring Nut (Hex nut on request) (Please order crimp contacts separately, see page 56)							
3	C091 31G003 100 2	C091 31G003 200 2	C091 11G003 000 2				
4	C091 31G004 100 2	C091 31G004 200 2	C091 11G004 000 2				
5	C091 31G005 100 2	C091 31G005 200 2	C091 11G005 000 2				
5S ²⁾	C091 31G105 100 2	C091 31G105 200 2	C091 11G105 000 2				
6	C091 31G006 100 2	C091 31G006 200 2	C091 11G006 000 2				
7	C091 31G007 100 2	C091 31G007 200 2	C091 11G007 000 2				
7 ²⁾	C091 31G107 100 2	C091 31G107 200 2	C091 11G107 000 2				
8	C091 31G008 100 2	C091 31G008 200 2	C091 11G008 000 2				
12	C091 31G012 100 2	C091 31G012 200 2	C091 11G012 000 2				
14	C091 31G014 100 2	C091 31G014 200 2	C091 11G014 000 2				
3	C091 61G003 110 2	C091 61G003 210 2				<p>pin length 10.5 mm from flange solder area: tin plated</p>	
4	C091 61G004 110 2	C091 61G004 210 2					
5	C091 61G005 110 2	C091 61G005 210 2					
5S ²⁾	C091 61G105 110 2	C091 61G105 210 2					
6	C091 61G006 110 2	C091 61G006 210 2					
7	C091 61G007 110 2	C091 61G007 210 2					
7 ²⁾	C091 61G107 110 2	C091 61G107 210 2					
8	C091 61G008 110 2	C091 61G008 210 2					
12	C091 61G012 110 2	C091 61G012 210 2					
14	C091 61G014 110 2	C091 61G014 210 2					
3	C091 61G003 120 2	C091 61G003 220 2		<p>pin length 14.5 mm from flange solder area: tin plated</p>			
4	C091 61G004 120 2	C091 61G004 220 2					
5	C091 61G005 120 2	C091 61G005 220 2					
5S ²⁾	C091 61G105 120 2	C091 61G105 220 2					
6	C091 61G006 120 2	C091 61G006 220 2					
7	C091 61G007 120 2	C091 61G007 220 2					
7 ²⁾	C091 61G107 120 2	C091 61G107 220 2					
8	C091 61G008 120 2	C091 61G008 220 2					
12		C091 61G012 220 2					
14		C091 61G014 220 2					
3	C091 61G003 130 2	C091 61G003 230 2				<p>pin length 19.5 mm from flange solder area: tin plated</p>	
4	C091 61G004 130 2	C091 61G004 230 2					
5	C091 61G005 130 2	C091 61G005 230 2					
5S ²⁾	C091 61G105 130 2	C091 61G105 230 2					
6	C091 61G006 130 2	C091 61G006 230 2					
7	C091 61G007 130 2	C091 61G007 230 2					
7 ²⁾	C091 61G107 130 2	C091 61G007 230 2					
8	C091 61G008 130 2	C091 61G008 230 2					
12		C091 61G012 230 2					
14		C091 61G014 230 2					

Assembly instruction³⁾

Panel cutout

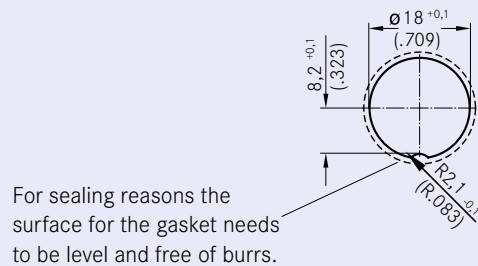
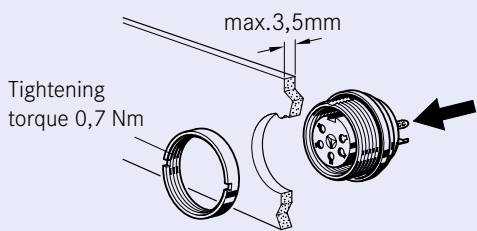

C 091 D Female receptacle | 90° | PCB mounting

No. of cont.	Part Number solder termination		Part Number crimp termination	Drawing	Figure
	silver plating	gold plating ¹⁾			
Ring Nut (Hex nut on request)			(Please order crimp contacts separately, see page 56)		
3					
4					
5					
5S ²⁾					
6					
7					
7 ²⁾					
8	C091 51G008 100 2	C091 51G008 200 2			
12					
14					

C 091 D Female receptacle | 90° | PCB mounting with board lock

No. of cont.	Part Number solder termination		Part Number crimp termination	Drawing	Figure
	silver plating	gold plating ¹⁾			
Ring Nut (Hex nut on request)			(Please order crimp contacts separately, see page 56)		
3					
4					
5					
5S ²⁾					
6					
7					
7 ²⁾					
8	C091 51G008 150 2	C091 51G008 250 2			
12					
14					

Panel cutout³⁾ | Female receptacle | 90° | PCB mounting | PCB mounting with board lock

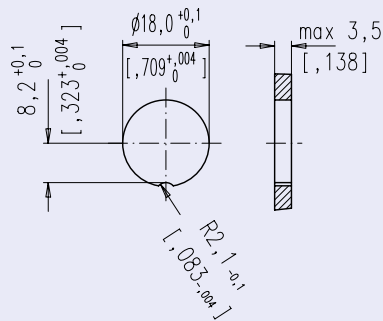

C 091 D Female receptacle | flange mounting

No. of cont.	Part Number solder termination		Part Number crimp termination	Drawing	Figure
	silver plating	gold plating ¹⁾			

Ring Nut (for hex nut see page 5) (Please order crimp contacts separately, see page 56)

3	C091 31T003 100 2	C091 31T003 200 2	C091 11T003 000 2
4	C091 31T004 100 2	C091 31T004 200 2	C091 11T004 000 2
5	C091 31T005 100 2	C091 31T005 200 2	C091 11T005 000 2
5S ²⁾	C091 31T105 100 2	C091 31T105 200 2	C091 11T105 000 2
6	C091 31T006 100 2	C091 31T006 200 2	C091 11T006 000 2
7	C091 31T007 100 2	C091 31T007 200 2	C091 11T007 000 2
7 ²⁾	C091 31T107 100 2	C091 31T107 200 2	C091 11T107 000 2
8	C091 31T008 100 2	C091 31T008 200 2	C091 11T008 000 2
12	C091 31T012 100 2	C091 31T012 200 2	C091 11T012 000 2
14	C091 31T014 100 2	C091 31T014 200 2	C091 11T014 000 2

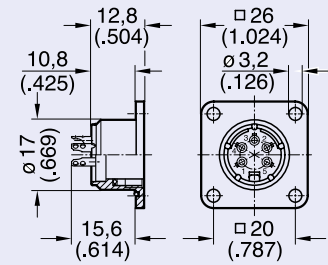

Panel cutout

For sealing reasons the surface for the gasket needs to be level and free of burrs. Provide suitable sealing for the screws.

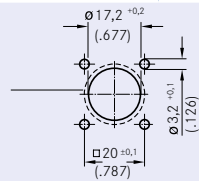

C 091 D Female receptacle | PCB-LAYOUT

PCB-LAYOUT (components side of circuit board)

Female receptacle | front mounting | rear mounting

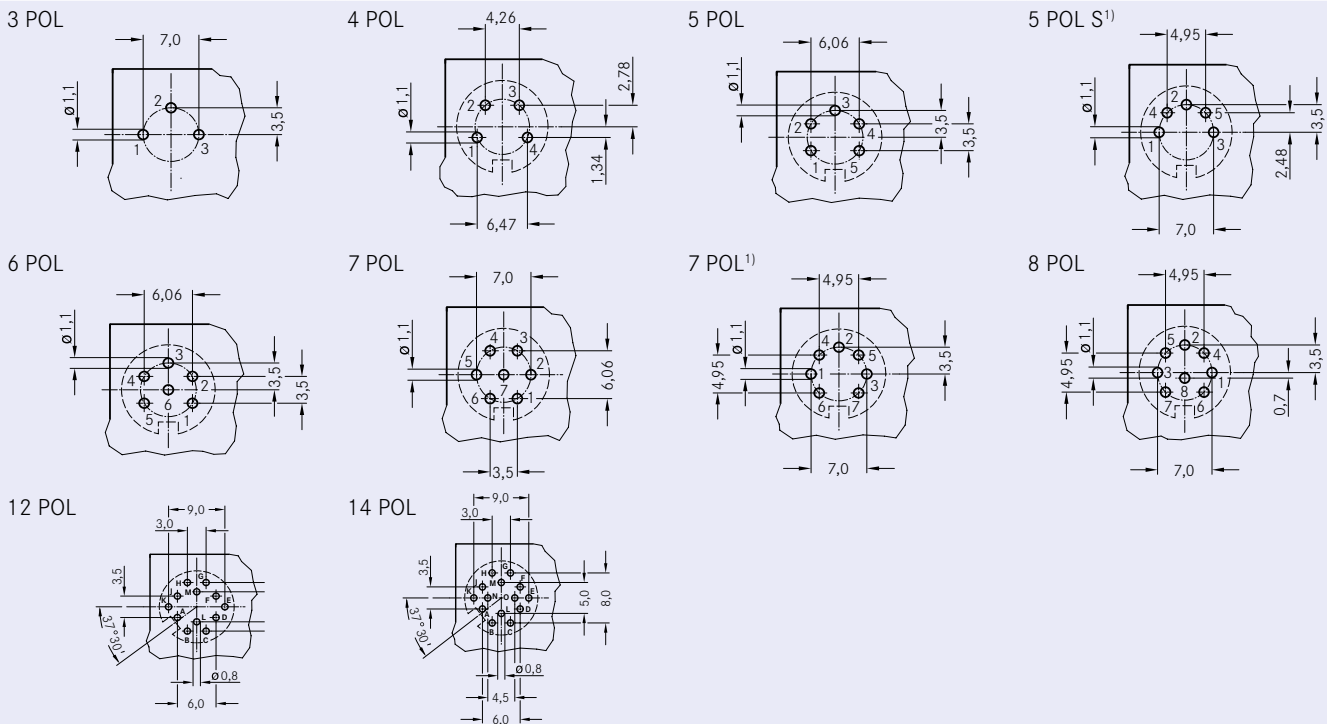

Female receptacle | 90° | PCB mounting

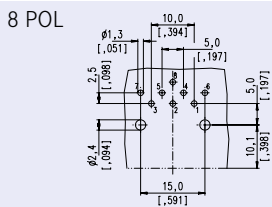

PCB mounting with board lock

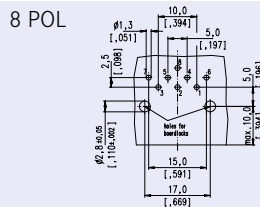

C 091 D+

- **M16 size**
- **Screw locking according to IEC 61076-2-106**
- **Metal locking ring**
- **3 - 8, 12 and 14 positions for crimp and solder**
- **IP 69K / IP 68**
- **Internal strain relief**
- **Male and female cable connectors straight**
- **Male and female receptacles see C091D**
- **UL registered under file number E 63 093 UL**
- **Reduced Assembling Time**
- **Easy and reliable assembly**
- **Outer cable diameter up to 10,5mm**
- **360° shielding (resistance 40 db)**
- **Connectors are compliant with AISG-standard**



C 091 D+ Characteristics

General Characteristics	Standard	Characteristics											
Number of contacts		3	4	5	5 Stereo	6	7	7	8	12	14		
View on termination side of male contact insert													
Contact arrangement	DIN EN 61076-2-106	03-a ✓	04-a ✓	05-a ✓	05-b ✓	06-a ✓	07-a ✓	07-b ✓	08-a ✓	12-a ✓	14-a ✓		
Contact arrangement	IEC 60130-9 ¹⁾	✓	✓		✓	✓		✓	✓				
Electrical Characteristics													
Rated voltage ²⁾	IEC 60664-1	300 V ≈ (100 V ≈)		300 V ≈ (63 V ≈)	100 V ≈ (32 V ≈)	300 V ≈ (63 V ≈)		100 V ≈ (32 V ≈)		150 V ≈ (32 V ≈)			
Rated impulse withstand voltage ²⁾	IEC 60664-1	1500 V (840 V)			1200 V (500 V)	1500 V (840 V)		1200 V (500 V)					
Pollution degree ²⁾	IEC 60664-1	1 (3 ³⁾)											
Installation category	IEC 60664-1	I											
Insulation group	IEC 60664-1	II, 400 ≤ CTI < 600											
Current rating	IEC 60512-5-2 UL 1977	10 A / + 40 °C			7 A / + 40 °C					3 A / + 40 °C + 104 °F			
Insulation resistance	IEC 60512-3-1	> 10 ¹⁰ Ω ⁴⁾											
Contact resistance	IEC 60512-2-1	< 5 m Ω											
Climatic Characteristics													
Climatic category	IEC 60668-1	40 / 100 / 21											
Temperature range	IEC 60668-1	- 40 °C ... + 100 °C											
Salt Spray Resistance	DIN IEC 60068-2-11, Test Ka	720h											
Mechanical Characteristics													
IP-degree	IEC 60529	IP 69K / IP 68											
Insertion and withdrawal forces	IEC 60512-13-2	25 N 90.oz	30 N 110.oz	35 N 125.oz	50 N 180.oz	50 N 180.oz	60 N 220.oz	50 N 180.oz					
Mechanical operation	IEC 60512-9-1	Silver ≥ 500 mating cycles Gold ≥ 1000 mating cycles											
Materials													
Housing material		brass or zinc die cast nickel plated or thermoplast											
Dielectric material		thermoplastic											
Sealing material		chloroprene											
Contact plating		silver plated / gold plated ⁵⁾											
Further Characteristics													
Termination technique		solder, crimp											
Wire gauge		solder: ≤ 0,5 mm ² / 20 AWG crimp: 2 - 6 pol (excluding 5S): 0,09 - 1,00 mm ² / 28 - 18 AWG crimp: 5S, 7, 7S and 8-pol.: 0,09 - 0,75 mm ² / 28 - 20 AWG								solder: ≤ 0,25 mm ² / 24 AWG crimp: 0,09-0,25 mm ² / 28 - 24 AWG			
Flammability		UL 94 V0											
Locking system	IEC 60130-9	metal screw coupling; tightening torque 1,0 - 1,5 Nm											

Caution: Do not connect or disconnect under load. Metal housing parts shall be securely incorporated to protected ground.

¹⁾ Edition 2000-05

²⁾ Values in brackets are according to DIN EN 61076-2-106

³⁾ Designed acc. pollution degree 2; can be used under pollution degree 3 when the rules of IEC 60644-1 are fulfilled

⁴⁾ Under operating conditions >10⁸ Ω

⁵⁾ Remark for gold plated contacts: In order to avoid brittle inter-metallic connections, gold-plated terminals have to be tin-plated in the solder area.

IEC 60 664 ≙ DIN VDE 0110 ; IEC 60 512-x ≙ DIN EN 60 512-x; IEC 60 130-9 ≙ DIN EN 60 130-9; IEC 61076-2-106 ≙ DIN EN 61076-2-106

C 091 D+ Male cable connector

No. of cont.	Part Number solder termination		Part Number crimp termination	Drawing	Figure
	silver plating	gold plating ¹⁾			

(Please order crimp contacts separately, see page 56)

3	C091 31H003 100 4	C091 31H003 200 4	C091 11H003 000 4
4	C091 31H004 100 4	C091 31H004 200 4	C091 11H004 000 4
5	C091 31H005 100 4	C091 31H005 200 4	C091 11H005 000 4
5S ²⁾	C091 31H105 100 4	C091 31H105 200 4	C091 11H105 000 4
6	C091 31H006 100 4	C091 31H006 200 4	C091 11H006 000 4
7	C091 31H007 100 4	C091 31H007 200 4	C091 11H007 000 4
7 ²⁾	C091 31H107 100 4	C091 31H107 200 4	C091 11H107 000 4
8	C091 31H008 100 4	C091 31H008 200 4	C091 11H008 000 4
12	C091 31H012 100 4	C091 31H012 200 4	C091 11H012 000 4
14	C091 31H014 100 4	C091 31H014 200 4	C091 11H014 000 4

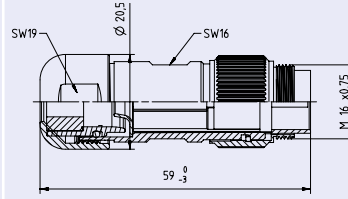

for cable diameter 4-6 mm

3	C091 31H003 101 4	C091 31H003 201 4	C091 11H003 001 4
4	C091 31H004 101 4	C091 31H004 201 4	C091 11H004 001 4
5	C091 31H005 101 4	C091 31H005 201 4	C091 11H005 001 4
5S ²⁾	C091 31H105 101 4	C091 31H105 201 4	C091 11H105 001 4
6	C091 31H006 101 4	C091 31H006 201 4	C091 11H006 001 4
7	C091 31H007 101 4	C091 31H007 201 4	C091 11H007 001 4
7 ²⁾	C091 31H107 101 4	C091 31H107 201 4	C091 11H107 001 4
8	C091 31H008 101 4	C091 31H008 201 4	C091 11H008 001 4
12	C091 31H012 101 4	C091 31H012 201 4	C091 11H012 001 4
14	C091 31H014 101 4	C091 31H014 201 4	C091 11H014 001 4

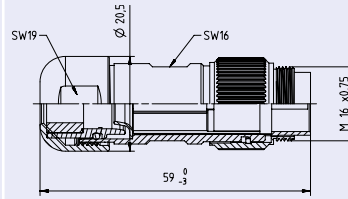

for cable diameter 6-8 mm

3	C091 31H003 102 4	C091 31H003 202 4	C091 11H003 002 4
4	C091 31H004 102 4	C091 31H004 202 4	C091 11H004 002 4
5	C091 31H005 102 4	C091 31H005 202 4	C091 11H005 002 4
5S ²⁾	C091 31H105 102 4	C091 31H105 202 4	C091 11H105 002 4
6	C091 31H006 102 4	C091 31H006 202 4	C091 11H006 002 4
7	C091 31H007 102 4	C091 31H007 202 4	C091 11H007 002 4
7 ²⁾	C091 31H107 102 4	C091 31H107 202 4	C091 11H107 002 4
8	C091 31H008 102 4	C091 31H008 202 4	C091 11H008 002 4
12	C091 31H012 102 4	C091 31H012 202 4	C091 11H012 002 4
14	C091 31H014 102 4	C091 31H014 202 4	C091 11H014 002 4

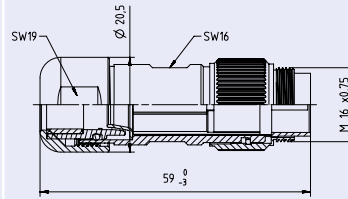

for cable diameter 8-10,5 mm



Assembly instruction

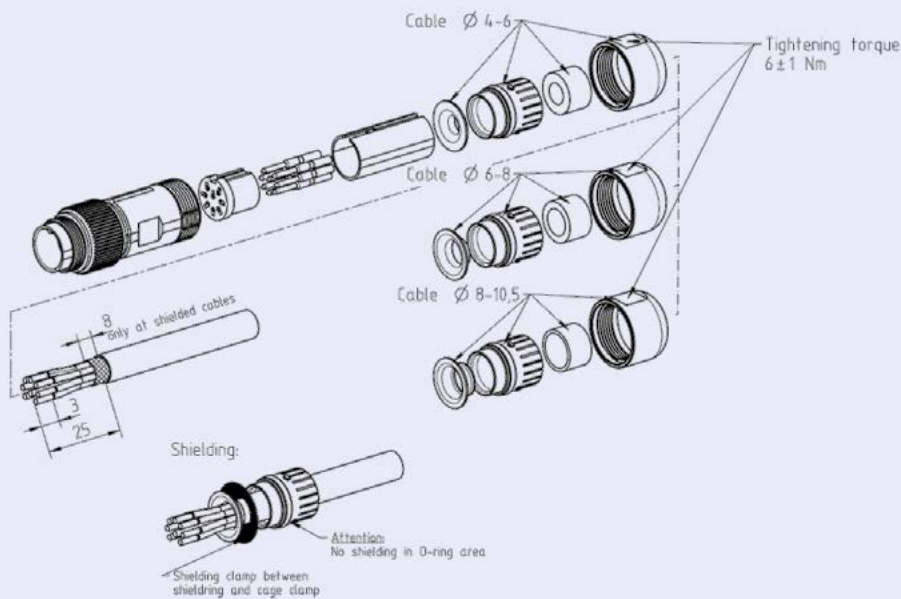

C091D+ connectors are fully intermateable with C091D connectors.
Receptacles to mate with C091D+ can be found in section C091D.

C 091 D+ Female cable connector

No. of cont.	Part Number solder termination		Part Number crimp termination	Drawing	Figure
	silver plating	gold plating ¹⁾			

(Please order crimp contacts separately, see page 56)

3	C091 31D003 100 4	C091 31D003 200 4	C091 11D003 000 4
4	C091 31D004 100 4	C091 31D004 200 4	C091 11D004 000 4
5	C091 31D005 100 4	C091 31D005 200 4	C091 11D005 000 4
5S ²⁾	C091 31D105 100 4	C091 31D105 200 4	C091 11D105 000 4
6	C091 31D006 100 4	C091 31D006 200 4	C091 11D006 000 4
7	C091 31D007 100 4	C091 31D007 200 4	C091 11D007 000 4
7 ²⁾	C091 31D107 100 4	C091 31D107 200 4	C091 11D107 000 4
8	C091 31D008 100 4	C091 31D008 200 4	C091 11D008 000 4
12	C091 31D012 100 4	C091 31D012 200 4	C091 11D012 000 4
14	C091 31D014 100 4	C091 31D014 200 4	C091 11D014 000 4

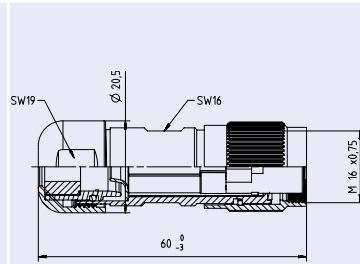

for cable diameter 4-6 mm

3	C091 31D003 101 4	C091 31D003 201 4	C091 11D003 001 4
4	C091 31D004 101 4	C091 31D004 201 4	C091 11D004 001 4
5	C091 31D005 101 4	C091 31D005 201 4	C091 11D005 001 4
5S ²⁾	C091 31D105 101 4	C091 31D105 201 4	C091 11D105 001 4
6	C091 31D006 101 4	C091 31D006 201 4	C091 11D006 001 4
7	C091 31D007 101 4	C091 31D007 201 4	C091 11D007 001 4
7 ²⁾	C091 31D107 101 4	C091 31D107 201 4	C091 11D107 001 4
8	C091 31D008 101 4	C091 31D008 201 4	C091 11D008 001 4
12	C091 31D012 101 4	C091 31D012 201 4	C091 11D012 001 4
14	C091 31D014 101 4	C091 31D014 201 4	C091 11D014 001 4

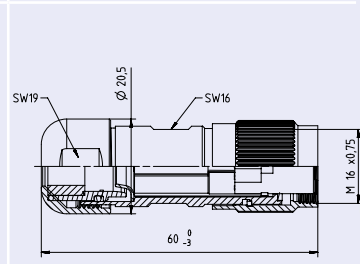

for cable diameter 6-8 mm

3	C091 31D003 102 4	C091 31D003 202 4	C091 11D003 002 4
4	C091 31D004 102 4	C091 31D004 202 4	C091 11D004 002 4
5	C091 31D005 102 4	C091 31D005 202 4	C091 11D005 002 4
5S ²⁾	C091 31D105 102 4	C091 31D105 202 4	C091 11D105 002 4
6	C091 31D006 102 4	C091 31D006 202 4	C091 11D006 002 4
7	C091 31D007 102 4	C091 31D007 202 4	C091 11D007 002 4
7 ²⁾	C091 31D107 102 4	C091 31D107 202 4	C091 11D107 002 4
8	C091 31D008 102 4	C091 31D008 202 4	C091 11D008 002 4
12	C091 31D012 102 4	C091 31D012 202 4	C091 11D012 002 4
14	C091 31D014 102 4	C091 31D014 202 4	C091 11D014 002 4

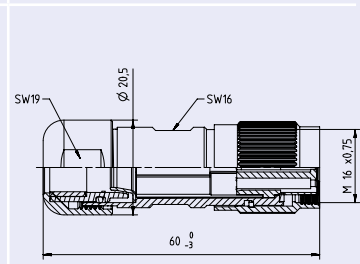

for cable diameter 8-10,5 mm



Assembly instruction

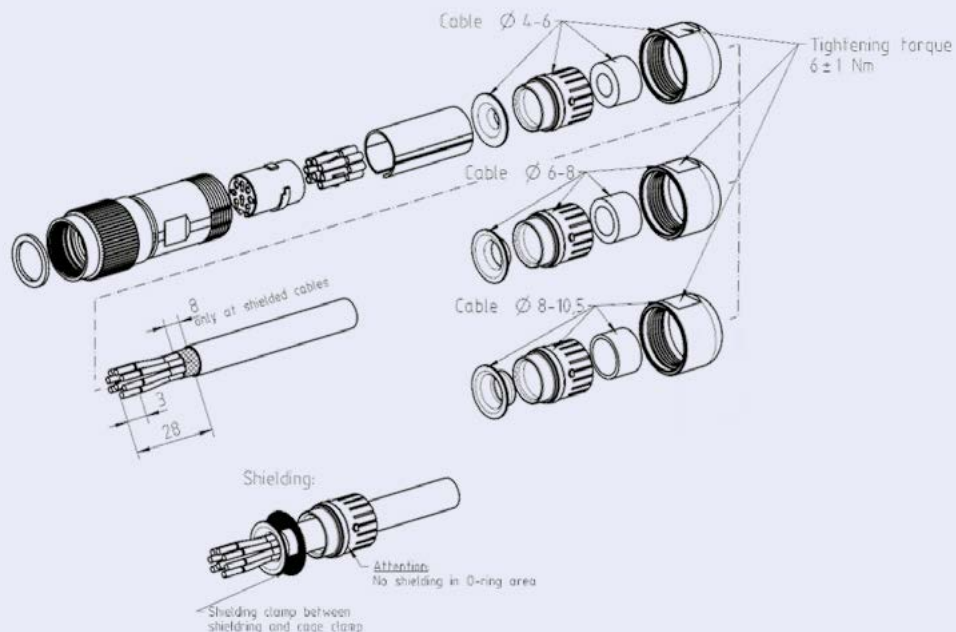

C091D+ connectors are fully intermateable with C091D connectors.
Receptacles to mate with C091D+ can be found in section C091D.

C 091 Crimp contacts

Supplied as	Wire Gauge	Insul. Ø mm	Pieces	Part Number		Figure	
				Silver	Gold		
Pin contact Ø 1.5 mm							
single contact	0.09-0.25 mm ²	0.7-1.6	100	VN01 015 0052 (1)	VN01 015 0052 (2)		
contacts on reel							
right			2000	HN01 015 0052 (1)	HN01 015 0052 (2)		
left	2000	TN01 015 0052 (1)	TN01 015 0052 (2)				
single contact	0.35-0.50 mm ²	1.0-2.0	100	VN01 015 0046 (1)	VN01 015 0046 (2)		
contacts on reel							
right			200	ZN01 015 0046 (1)	ZN01 015 0046 (2)		
left	2000	HN01 015 0046 (1)	HN01 015 0046 (2)				
left	2000	TN01 015 0046 (1)	TN01 015 0046 (2)				
single contact	0.75-1.0 mm ²	1.6-2.1	100	VN01 015 0047 (1)	VN01 015 0047 (2)		
contacts on reel							
right			200	ZN01 015 0047 (1)	ZN01 015 0047 (2)		
left	2000	HN01 015 0047 (1)	HN01 015 0047 (2)				
left	2000	TN01 015 0047 (1)	TN01 015 0047 (2)				
Pin contact Ø 1.0 mm							
	0.09-0.25 mm ²	0.7-1.3	100	VN01 010 0158 (1)	VN01 010 0158 (2)		
					2000		HN01 010 0158 (1)
			2000	TN01 010 0158 (1)	TN01 010 0158 (2)		
Socket contact Ø 1.5 mm							
single contact	0.09-0.25 mm ²	0.7-1.6	100	VN02 015 0052 (1)	VN02 015 0052 (2)		
contacts on reel							
right			2000	HN02 015 0052 (1)	HN02 015 0052 (2)		
left	2000	TN02 015 0052 (1)	TN02 015 0052 (2)				
single contact	0.35-0.50 mm ²	1.0-2.0	100	VN02 015 0046 (1)	VN02 015 0046 (2)		
contacts on reel							
right			200	ZN02 015 0046 (1)	ZN02 015 0046 (2)		
left	2000	HN02 015 0046 (1)	HN02 015 0046 (2)				
left	2000	TN02 015 0046 (1)	TN02 015 0046 (2)				
single contact	0.75-1.0 mm ²	1.6-2.1	100	VN02 015 0047 (1)	VN02 015 0047 (2)		
contacts on reel							
right			200	ZN02 015 0047 (1)	ZN02 015 0047 (2)		
left	2000	HN02 015 0047 (1)	HN02 015 0047 (2)				
left	2000	TN02 015 0047 (1)	TN02 015 0047 (2)				
Socket contact Ø 1.0 mm							
	0.09-0.25 mm ²	0.7-1.3	100	VN02 010 0158 (1)	VN02 010 0158 (2)		
					2000	HN02 010 0158 (1)	HN02 010 0158 (2)
			2000	TN02 010 0158 (1)	TN02 010 0158 (2)		

Connecting Range mm ²	Wire Gauge		Stripping Length mm	Crimp Height (Average Values) mm	Crimp Retention Force acc. DIN EN 60352-2 N	
	mm ²	AWG				
0.09-0.25	0.09	28	3.0 + 0.5	0.85-0.89	11	
		26			15	
	0.14	24		0.86-0.90	18	
					28	
0.35-0.50	0.25	22	3.0 + 0.5	0.91-0.97	32	
	0.35			20	0.90-1.06	40
	0.50			20	0.95-1.11	60
0.75-1.00	0.75	18	3.5 + 1.0	1.33-1.50	85	
					90	
	1.00			1.36-1.53	108	

These min. values are based on the copper wire tensile strength with $\delta_B \approx 230 \text{ N/mm}^2$.

C 091 Tools

Description	Wire Gauge	Part Number		
		Contact Locator	Crimping Dies	Tool
Tools for 1.5 mm contacts				
Removal tool for contacts	-	-	-	FH 0200 0911
Crimping tool for single contacts	0.09 - 0.50 mm ²	TA 0012 091 0001	TA 0000 503	TA 0000
	0.35 - 1.00 mm ²	TA 0002 091 0001	TA 0000 502	TA 0000
Tools for 1.0 mm contacts				
Removal tool for contacts	-	-	-	FH 0200 0912
Crimping tool for single contacts	0.09 - 0.25 mm ²	TA 0003 091 0001	TA 0000 504	TA 0000

C 091 Accessories

Description	for Series	Part Number	Drawing	Figure
Spanner wrench for receptacles with ring nut	C 091 A C 091 B C 091 D	N 45 091 000 1		
Spanner wrench for male and female cable connectors	C 091 A C 091 B C 091 D	FH 0300 091		
Torque wrench	C 091 D+	FH 0400 091		
Hex nut for male and female receptacles	C 091 A C 091 B C 091 D	T 0422 060 9		
Colored back-shells thermoplast Colour: blue Colour: red Colour: yellow Colour: green	C 091 A C 091 B	T 2993 510 9 T 2993 511 9 T 2993 512 9 T 2993 513 9		

C 091 Protective Caps

Description	L	Part Number	Drawing	Figure
For male cable connector				
metal cap with plastic leash	85 mm	C091 00U000 120 2		
For male receptacles				
metal cap with plastic leash	60 mm 100 mm	C091 00U000 130 2 C091 00U000 131 2		
metal cap with metal chain	110 mm	C091 00U000 152 2		
For female cable connector				
metal cap with plastic leash	85 mm	C091 00V000 120 2		
For female receptacles				
metal cap with plastic leash	60 mm 100 mm	C091 00V000 130 2 C091 00V000 131 2		
metal cap with metal chain	110 mm	C091 00V000 152 2		
plastic cap with cord	90 mm	C091 00V000 163 2		
plastic cap without cord		C091 00V000 169 2		

The following current derating curves refer to the stated numbers of contacts and wire gauges, when all contacts are simultaneously loaded with the same current. The maximum ambient temperature for the series C091 is 100°C.

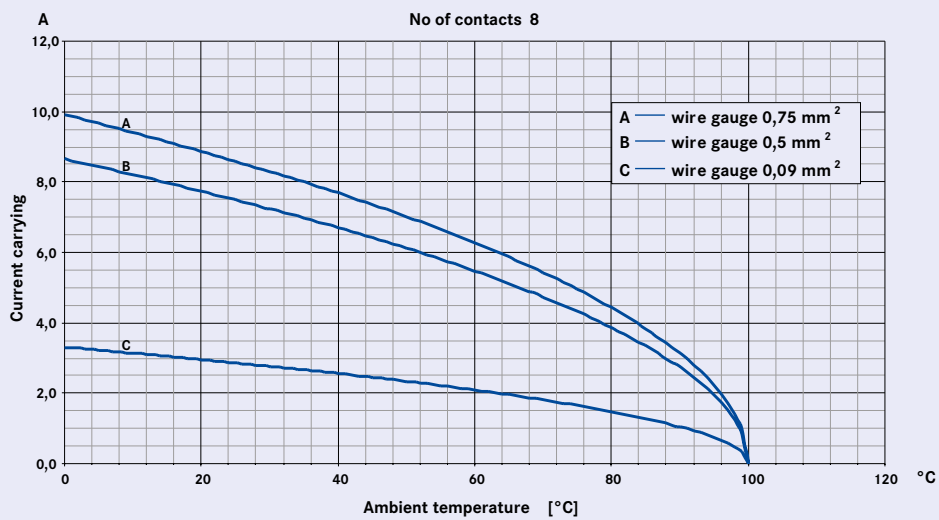
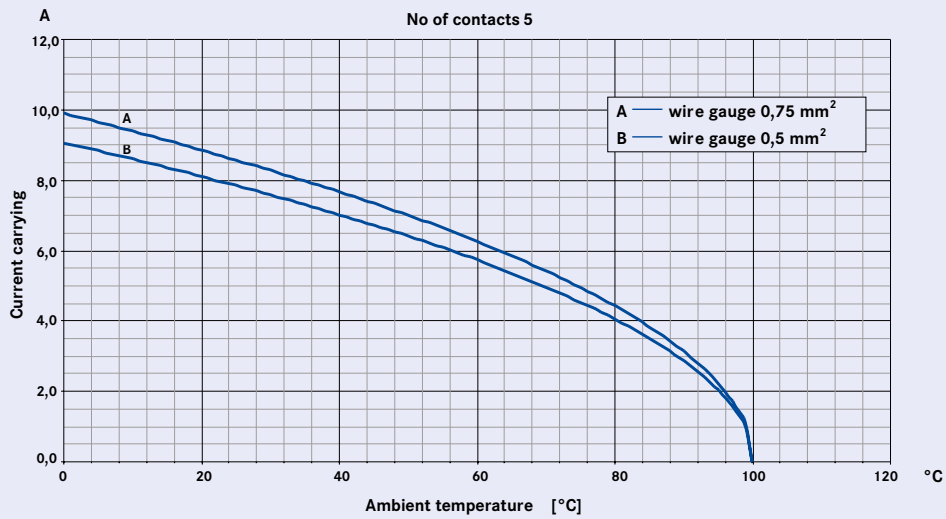
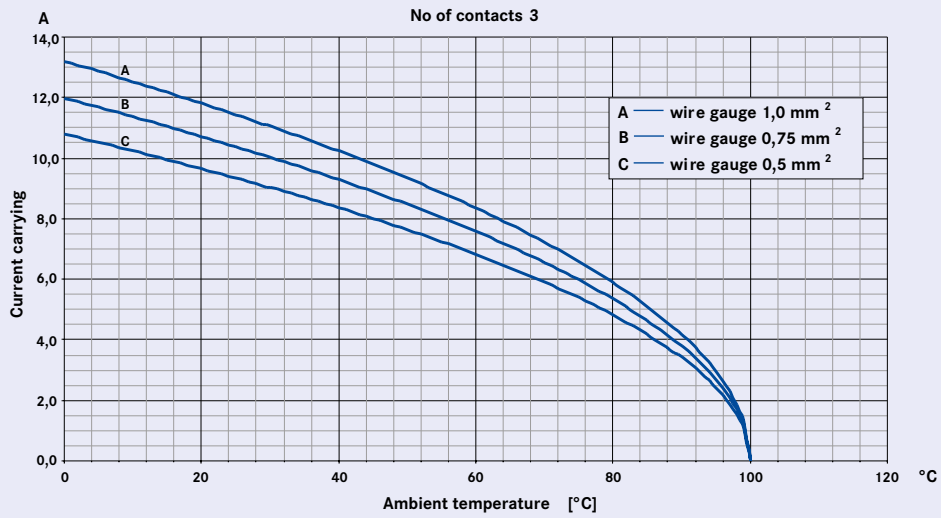



1. General Remarks

These connectors are designed and produced in conformity with the low voltage directive (73/23/EWG) respectively Gerätesicherheitsgesetz (German law) and are especially in accordance with the standards DIN EN 61984 (VDE 0627); IEC 60664-1 (VDE 0110-1) and IEC 60529.

The connectors may be used only within the technical ratings. All technical data refer to mated connectors under live conditions. The safety of the connector system depends on the correct selection of products, proper assembly of the connector device, and a precise fit of the connectors.

2. Application Remarks

Connectors with / without breaking capacity must be used according to specified technical ratings.

The technical data represent the initial value of mated parts under predetermined conditions and length of time. These values could change with different test parameters or product requirements. The C 091 Series connectors are used in a wide variety of industries and equipment. Some of these include industrial machines and controls, data processing, instrumentation and test equipment, medical devices, telecommunication's network and equipment, plus outdoor and marine applications.

All rated data for the connectors listed in this catalog are based on over-voltage category and pollution degree for electronic applications. Connectors were completely mated according to their respective safety locking mechanism. Selection and testing of connectors with / without breaking capacity to meet specific product or industrial requirements such as rated voltage and the related clearances and creepage distances are the responsibility of the user.

3. Assembling Remarks

Certain appliances and equipment include protective measures that relate to the coupling devices of the male and female receptacle housings. (See also DIN VDE 0100 part 410; IEC 60364-4-41.)

Care must be taken to insure the parts are correctly mated and screws are tightened with the proper torque. Protection against electrical shock on the termination side of the connector (receptacles, contact insert) shall be secured by suitable mounting.

4. Termination Remarks

The dimensions as stated in the assembly instructions are for general information only and can vary depending on cable styles and types. Please note in the case of an internal strain relief: Always clamp the outer cable mantle (not the individual lead wires) to avoid damage of the lead wire insulation. In case of shielded cables, fold the braid over the outer mantle to avoid damage of the lead wire insulation when clamping the braid.

In case of clamping rings, make sure that the lead wire insulation is not damaged when connecting (clamping) the braid.

Cable connectors are effectively secured when using the internal cable clamp. When the connector contains a simple gland bushing for retention the cable should have a strain relief close behind the connector. All cable properties or specifications must be compatible with the connector design and materials.

Designated wire conductors must be terminated to the correct poles in the connector. Please make sure that the usability of the cable in conjunction with the clamping ring is given.

Crimp contacts must be fully inserted into the plastic housing and retention assured with a slight tug on the wire.

Wire should be stripped correctly according to printed specifications to ensure no electrical contact can be made between the conductors. There should be no nicked or cut strains during the stripping action.

5. Classification according to DIN EN 61984 / IEC 61984 (VDE 0627)

Style	enclosed	unenclosed	protective earthing contact	cable clamp	finger safety mated	finger safety unmated	hand back safety mated	Connector with breaking capacity ¹⁾	rewirable
Male cable connector		X		X	X				X
Female cable connector	X			X	X	X	X		X
Male panel connector					X ¹⁾				X
Female panel connector		X			X ¹⁾	X ¹⁾	X ¹⁾		X

Degree of protection

Electrical devices to which connectors belong have to be protected for safety reasons from outside influences like dust, foreign objects, direct contact, moisture and water. This protection is provided on industrial connectors by their housings with their latching devices and sealed cable entries.

The degree of protection can be selected depending on the type of intended use. The standard IEC 60529 and/or DIN EN 60529 has specified the degree of protection and divided into several classes.

The degree of protection is indicated in the following way: IP 65
 Code letters (Internat. Protection)
 1st charact. numeral (degree of protection against access to hazardous parts and against solid foreign objects)
 2nd charact. numeral (degree of protection against ingress of water)

1st charact. numeral	Brief description	Definition	2nd charact. numeral	Brief description	Definition
0	Non-protected	–	0	Non-protected	–
1	Protected against access to hazardous parts with the back of a hand. Protected against solid foreign objects of $\geq 50\text{mm } \varnothing$.	The probe, sphere of $50\text{mm } \varnothing$, shall not fully penetrate and shall have adequate clearance from hazardous parts.	1	Protected against vertically falling water drops	Vertically falling drops shall have no harmful effects.
2	Protected against access to hazardous parts with a finger. Protected against solid foreign objects of $\geq 12,5\text{mm } \varnothing$.	The jointed test finger of $12\text{mm } \varnothing$, 80mm length, shall have adequate clearance from hazardous parts. The probe, sphere of $12,5\text{mm } \varnothing$, shall not fully penetrate.	2	Protected against vertically falling water drops when enclosure tilted up to 15°	Vertically falling drops shall have no harmful effects when the enclosure is tilted at any angle up to 15° on either side of the vertical.
3	Protected against access to hazardous parts with a tool. Protected against solid foreign objects of $\geq 2,5\text{mm } \varnothing$.	The probe of $2,5\text{mm } \varnothing$ shall not penetrate at all.	3	Protected against spraying water	Water sprayed at an angle upto 60° on either side of the vertical shall have no harmful effects.
4	Protected against access to hazardous parts with a wire. Protected against solid foreign objects of $\geq 1\text{mm } \varnothing$.	The probe of $1\text{mm } \varnothing$ shall not penetrate at all.	4	Protected against splashing water	Water splashed against the enclosure from any direction shall have no harmful effects.
5	Protected against access to hazardous parts with a wire. Dust-protected.	The probe of $1\text{mm } \varnothing$ shall not penetrate. Intrusion of dust is not totally prevented, but dust shall not penetrate in a quantity to interfere with satisfactory operation of the device or to impair safety.	5	Protected against water jets	Water projected in jets against the enclosure from any direction shall have no harmful effects.
6	Protected against access to hazardous parts with a wire. Dust-tight.	The probe of $1\text{mm } \varnothing$ shall not penetrate. No intrusion of dust.	6	Protected against powerful water jets	Water projected in powerful jets against the enclosure from any direction shall have no harmful effects.
			7	Protected against the effects of temporary immersion in water	Intrusion of water in quantities causing harmful effects shall not be possible when the enclosure is temporarily immersed in water for 30 min. in 1m depth.
			8	Protected against the effects of continous immersion in water	Intrusion of water in quantities causing harmful effects shall not be possible when the enclosure is continuously immersed in water under conditions which shall be agreed between manufacturer and user but which are more severe than for numeral 7.
			9K ¹⁾	Protected against water during high pressure/steam jet cleaning	Water projected in powerful jets with high pressure and heat against the enclosure from any direction shall have no harmful effects.

Part Number	Page	Part Number	Page	Part Number	Page	Part Number	Page
C091 00U000 120 2	58	C091 11D105 001 2	44	C091 11H007 002 4	54	C091 11S012 000 2	47
C091 00U000 130 2	58	C091 11D105 001 4	55	C091 11H008 000 2	42	C091 11S014 000 2	47
C091 00U000 131 2	58	C091 11D105 002 4	55	C091 11H008 000 4	54	C091 11S105 000 2	47
C091 00U000 152 2	58	C091 11D107 000 2	44	C091 11H008 001 2	42	C091 11S107 000 2	47
C091 00V000 120 2	58	C091 11D107 000 4	55	C091 11H008 001 4	54	C091 11T003 000 2	51
C091 00V000 130 2	58	C091 11D107 001 2	44	C091 11H008 002 4	54	C091 11T004 000 2	51
C091 00V000 131 2	58	C091 11D107 001 4	55	C091 11H012 000 2	42	C091 11T005 000 2	51
C091 00V000 152 2	58	C091 11D107 002 4	55	C091 11H012 000 4	54	C091 11T006 000 2	51
C091 00V000 163 2	58	C091 11F003 000 2	44	C091 11H012 001 2	42	C091 11T007 000 2	51
C091 00V000 169 2	58	C091 11F003 001 2	44	C091 11H012 001 4	54	C091 11T008 000 2	51
C091 11C003 000 2	46	C091 11F004 000 2	44	C091 11H012 002 4	54	C091 11T012 000 2	51
C091 11C004 000 2	46	C091 11F004 001 2	44	C091 11H014 000 2	42	C091 11T014 000 2	51
C091 11C005 000 2	46	C091 11F005 000 2	44	C091 11H014 000 4	54	C091 11T105 000 2	51
C091 11C006 000 2	46	C091 11F005 001 2	44	C091 11H014 001 2	42	C091 11T107 000 2	51
C091 11C007 000 2	46	C091 11F006 000 2	44	C091 11H014 001 4	54	C091 11W003 000 2	46
C091 11C008 000 2	46	C091 11F006 001 2	44	C091 11H014 002 4	54	C091 11W004 000 2	46
C091 11C012 000 2	46	C091 11F007 000 2	44	C091 11H105 000 2	42	C091 11W005 000 2	46
C091 11C014 000 2	46	C091 11F007 001 2	44	C091 11H105 000 4	54	C091 11W006 000 2	46
C091 11C105 000 2	46	C091 11F008 000 2	44	C091 11H105 001 2	42	C091 11W007 000 2	46
C091 11C107 000 2	46	C091 11F008 001 2	44	C091 11H105 001 4	54	C091 11W008 000 2	46
C091 11D003 000 2	44	C091 11F012 000 2	44	C091 11H105 002 4	54	C091 11W012 000 2	46
C091 11D003 000 4	55	C091 11F012 001 2	44	C091 11H107 000 2	42	C091 11W014 000 2	46
C091 11D003 001 2	44	C091 11F014 000 2	44	C091 11H107 000 4	54	C091 11W105 000 2	46
C091 11D003 001 4	55	C091 11F014 001 2	44	C091 11H107 001 2	42	C091 11W107 000 2	46
C091 11D003 002 4	55	C091 11F105 000 2	44	C091 11H107 001 4	54	C091 31C003 100 2	46
C091 11D004 000 2	44	C091 11F105 001 2	44	C091 11H107 002 4	54	C091 31C003 200 2	46
C091 11D004 000 4	55	C091 11F107 000 2	44	C091 11K003 000 2	42	C091 31C004 100 2	46
C091 11D004 001 2	44	C091 11F107 001 2	44	C091 11K003 001 2	42	C091 31C004 200 2	46
C091 11D004 001 4	55	C091 11G003 000 2	49	C091 11K004 000 2	42	C091 31C005 100 2	46
C091 11D004 002 4	55	C091 11G004 000 2	49	C091 11K004 001 2	42	C091 31C005 200 2	46
C091 11D005 000 2	44	C091 11G005 000 2	49	C091 11K005 000 2	42	C091 31C006 100 2	46
C091 11D005 000 4	55	C091 11G006 000 2	49	C091 11K005 001 2	42	C091 31C006 200 2	46
C091 11D005 001 2	44	C091 11G007 000 2	49	C091 11K006 000 2	42	C091 31C007 100 2	46
C091 11D005 001 4	55	C091 11G008 000 2	49	C091 11K006 001 2	42	C091 31C007 200 2	46
C091 11D005 002 4	55	C091 11G012 000 2	49	C091 11K007 000 2	42	C091 31C008 100 2	46
C091 11D006 000 2	44	C091 11G014 000 2	49	C091 11K007 001 2	42	C091 31C008 200 2	46
C091 11D006 000 4	55	C091 11G105 000 2	49	C091 11K008 000 2	42	C091 31C012 100 2	46
C091 11D006 001 2	44	C091 11G107 000 2	49	C091 11K008 001 2	42	C091 31C012 200 2	46
C091 11D006 001 4	55	C091 11H003 000 2	42	C091 11K012 000 2	42	C091 31C014 100 2	46
C091 11D006 002 4	55	C091 11H003 000 4	54	C091 11K012 001 2	42	C091 31C014 200 2	46
C091 11D007 000 2	44	C091 11H003 001 2	42	C091 11K014 000 2	42	C091 31C105 100 2	46
C091 11D007 000 4	55	C091 11H003 001 4	54	C091 11K014 001 2	42	C091 31C105 200 2	46
C091 11D007 001 2	44	C091 11H003 002 4	54	C091 11K105 000 2	42	C091 31C107 100 2	46
C091 11D007 001 4	55	C091 11H004 000 2	42	C091 11K105 001 2	42	C091 31C107 200 2	46
C091 11D007 002 4	55	C091 11H004 000 4	54	C091 11K107 000 2	42	C091 31D003 100 2	44
C091 11D008 000 2	44	C091 11H004 001 2	42	C091 11K107 001 2	42	C091 31D003 100 4	55
C091 11D008 000 4	55	C091 11H004 001 4	54	C091 11N003 000 2	48	C091 31D003 101 2	44
C091 11D008 001 2	44	C091 11H004 002 4	54	C091 11N004 000 2	48	C091 31D003 101 4	55
C091 11D008 001 4	55	C091 11H005 000 2	42	C091 11N005 000 2	48	C091 31D003 102 4	55
C091 11D008 002 4	55	C091 11H005 000 4	54	C091 11N006 000 2	48	C091 31D003 200 2	44
C091 11D012 000 2	44	C091 11H005 001 2	42	C091 11N007 000 2	48	C091 31D003 200 4	55
C091 11D012 000 4	55	C091 11H005 001 4	54	C091 11N008 000 2	48	C091 31D003 201 2	44
C091 11D012 001 2	44	C091 11H005 002 4	54	C091 11N012 000 2	48	C091 31D003 201 4	55
C091 11D012 001 4	55	C091 11H006 000 2	42	C091 11N014 000 2	48	C091 31D003 202 4	55
C091 11D012 002 4	55	C091 11H006 000 4	54	C091 11N105 000 2	48	C091 31D004 100 2	44
C091 11D014 000 2	44	C091 11H006 001 2	42	C091 11N107 000 2	48	C091 31D004 100 4	55
C091 11D014 000 4	55	C091 11H006 001 4	54	C091 11S003 000 2	47	C091 31D004 101 2	44
C091 11D014 001 2	44	C091 11H006 002 4	54	C091 11S004 000 2	47	C091 31D004 101 4	55
C091 11D014 001 4	55	C091 11H007 000 2	42	C091 11S005 000 2	47	C091 31D004 102 4	55
C091 11D014 002 4	55	C091 11H007 000 4	54	C091 11S006 000 2	47	C091 31D004 200 2	44
C091 11D105 000 2	44	C091 11H007 001 2	42	C091 11S007 000 2	47	C091 31D004 200 4	55
C091 11D105 000 4	55	C091 11H007 001 4	54	C091 11S008 000 2	47	C091 31D004 201 2	44

Part Number	Page	Part Number	Page	Part Number	Page	Part Number	Page
C091 31D004 201 4	55	C091 31D105 100 2	44	C091 31G004 100 2	49	C091 31H007 102 4	54
C091 31D004 202 4	55	C091 31D105 100 4	55	C091 31G004 200 2	49	C091 31H007 200 2	42
C091 31D005 100 2	44	C091 31D105 101 2	44	C091 31G005 100 2	49	C091 31H007 200 4	54
C091 31D005 100 4	55	C091 31D105 101 4	55	C091 31G005 200 2	49	C091 31H007 201 2	42
C091 31D005 101 2	44	C091 31D105 102 4	55	C091 31G006 100 2	49	C091 31H007 201 4	54
C091 31D005 101 4	55	C091 31D105 200 2	44	C091 31G006 200 2	49	C091 31H007 202 4	54
C091 31D005 102 4	55	C091 31D105 200 4	55	C091 31G007 100 2	49	C091 31H008 100 2	42
C091 31D005 200 2	44	C091 31D105 201 2	44	C091 31G007 200 2	49	C091 31H008 100 4	54
C091 31D005 200 4	55	C091 31D105 201 4	55	C091 31G008 100 2	49	C091 31H008 101 2	42
C091 31D005 201 2	44	C091 31D105 202 4	55	C091 31G008 200 2	49	C091 31H008 101 4	54
C091 31D005 201 4	55	C091 31D107 100 2	44	C091 31G012 100 2	49	C091 31H008 102 4	54
C091 31D005 202 4	55	C091 31D107 100 4	55	C091 31G012 200 2	49	C091 31H008 200 2	42
C091 31D006 100 2	44	C091 31D107 101 2	44	C091 31G014 100 2	49	C091 31H008 200 4	54
C091 31D006 100 4	55	C091 31D107 101 4	55	C091 31G014 200 2	49	C091 31H008 201 2	42
C091 31D006 101 2	44	C091 31D107 102 4	55	C091 31G105 100 2	49	C091 31H008 201 4	54
C091 31D006 101 4	55	C091 31D107 200 2	44	C091 31G105 200 2	49	C091 31H008 202 4	54
C091 31D006 102 4	55	C091 31D107 200 4	55	C091 31G107 100 2	49	C091 31H012 100 2	42
C091 31D006 200 2	44	C091 31D107 201 2	44	C091 31G107 200 2	49	C091 31H012 100 4	54
C091 31D006 200 4	55	C091 31D107 201 4	55	C091 31H003 100 2	42	C091 31H012 101 2	42
C091 31D006 201 2	44	C091 31D107 202 4	55	C091 31H003 100 4	54	C091 31H012 101 4	54
C091 31D006 201 4	55	C091 31F003 100 2	44	C091 31H003 101 2	42	C091 31H012 102 4	54
C091 31D006 202 4	55	C091 31F003 101 2	44	C091 31H003 101 4	54	C091 31H012 200 2	42
C091 31D007 100 2	44	C091 31F003 200 2	44	C091 31H003 102 4	54	C091 31H012 200 4	54
C091 31D007 100 4	55	C091 31F003 201 2	44	C091 31H003 200 2	42	C091 31H012 201 2	42
C091 31D007 101 2	44	C091 31F004 100 2	44	C091 31H003 200 4	54	C091 31H012 201 4	54
C091 31D007 101 4	55	C091 31F004 101 2	44	C091 31H003 201 2	42	C091 31H012 202 4	54
C091 31D007 102 4	55	C091 31F004 200 2	44	C091 31H003 201 4	54	C091 31H014 100 2	42
C091 31D007 200 2	44	C091 31F004 201 2	44	C091 31H003 202 4	54	C091 31H014 100 4	54
C091 31D007 200 4	55	C091 31F005 100 2	44	C091 31H004 100 2	42	C091 31H014 101 2	42
C091 31D007 201 2	44	C091 31F005 101 2	44	C091 31H004 100 4	54	C091 31H014 101 4	54
C091 31D007 201 4	55	C091 31F005 200 2	44	C091 31H004 101 2	42	C091 31H014 102 4	54
C091 31D007 202 4	55	C091 31F005 201 2	44	C091 31H004 101 4	54	C091 31H014 200 2	42
C091 31D008 100 2	44	C091 31F006 100 2	44	C091 31H004 102 4	54	C091 31H014 200 4	54
C091 31D008 100 4	55	C091 31F006 101 2	44	C091 31H004 200 2	42	C091 31H014 201 2	42
C091 31D008 101 2	44	C091 31F006 200 2	44	C091 31H004 200 4	54	C091 31H014 201 4	54
C091 31D008 101 4	55	C091 31F006 201 2	44	C091 31H004 201 2	42	C091 31H014 202 4	54
C091 31D008 102 4	55	C091 31F007 100 2	44	C091 31H004 201 4	54	C091 31H105 100 2	42
C091 31D008 200 2	44	C091 31F007 101 2	44	C091 31H004 202 4	54	C091 31H105 100 4	54
C091 31D008 200 4	55	C091 31F007 200 2	44	C091 31H005 100 2	42	C091 31H105 101 2	42
C091 31D008 201 2	44	C091 31F007 201 2	44	C091 31H005 100 4	54	C091 31H105 101 4	54
C091 31D008 201 4	55	C091 31F008 100 2	44	C091 31H005 101 2	42	C091 31H105 102 4	54
C091 31D008 202 4	55	C091 31F008 101 2	44	C091 31H005 101 4	54	C091 31H105 200 2	42
C091 31D012 100 2	44	C091 31F008 200 2	44	C091 31H005 102 4	54	C091 31H105 200 4	54
C091 31D012 100 4	55	C091 31F008 201 2	44	C091 31H005 200 2	42	C091 31H105 201 2	42
C091 31D012 101 2	44	C091 31F012 100 2	44	C091 31H005 200 4	54	C091 31H105 201 4	54
C091 31D012 101 4	55	C091 31F012 101 2	44	C091 31H005 201 2	42	C091 31H105 202 4	54
C091 31D012 102 4	55	C091 31F012 200 2	44	C091 31H005 201 4	54	C091 31H107 100 2	42
C091 31D012 200 2	44	C091 31F012 201 2	44	C091 31H005 202 4	54	C091 31H107 100 4	54
C091 31D012 200 4	55	C091 31F014 100 2	44	C091 31H006 100 2	42	C091 31H107 101 2	42
C091 31D012 201 2	44	C091 31F014 101 2	44	C091 31H006 100 4	54	C091 31H107 101 4	54
C091 31D012 201 4	55	C091 31F014 200 2	44	C091 31H006 101 2	42	C091 31H107 102 4	54
C091 31D012 202 4	55	C091 31F014 201 2	44	C091 31H006 101 4	54	C091 31H107 200 2	42
C091 31D014 100 2	44	C091 31F105 100 2	44	C091 31H006 102 4	54	C091 31H107 200 4	54
C091 31D014 100 4	55	C091 31F105 101 2	44	C091 31H006 200 2	42	C091 31H107 201 2	42
C091 31D014 101 2	44	C091 31F105 200 2	44	C091 31H006 200 4	54	C091 31H107 201 4	54
C091 31D014 101 4	55	C091 31F105 201 2	44	C091 31H006 201 2	42	C091 31H107 202 4	54
C091 31D014 102 4	55	C091 31F107 100 2	44	C091 31H006 201 4	54	C091 31K003 100 2	42
C091 31D014 200 2	44	C091 31F107 101 2	44	C091 31H006 202 4	54	C091 31K003 101 2	42
C091 31D014 200 4	55	C091 31F107 200 2	44	C091 31H007 100 2	42	C091 31K003 200 2	42
C091 31D014 201 2	44	C091 31F107 201 2	44	C091 31H007 100 4	54	C091 31K003 201 2	42
C091 31D014 201 4	55	C091 31G003 100 2	49	C091 31H007 101 2	42	C091 31K004 100 2	42
C091 31D014 202 4	55	C091 31G003 200 2	49	C091 31H007 101 4	54	C091 31K004 101 2	42

Part Number	Page	Part Number	Page	Part Number	Page	Part Number	Page
C091 31K004 200 2	42	C091 31S007 100 2	47	C091 61G004 110 2	49	C091 61N005 110 2	48
C091 31K004 201 2	42	C091 31S007 200 2	47	C091 61G004 120 2	49	C091 61N005 120 2	48
C091 31K005 100 2	42	C091 31S008 100 2	47	C091 61G004 130 2	49	C091 61N005 130 2	48
C091 31K005 101 2	42	C091 31S008 200 2	47	C091 61G004 210 2	49	C091 61N005 210 2	48
C091 31K005 200 2	42	C091 31S012 100 2	47	C091 61G004 220 2	49	C091 61N005 220 2	48
C091 31K005 201 2	42	C091 31S012 200 2	47	C091 61G004 230 2	49	C091 61N005 230 2	48
C091 31K006 100 2	42	C091 31S014 100 2	47	C091 61G005 110 2	49	C091 61N006 110 2	48
C091 31K006 101 2	42	C091 31S014 200 2	47	C091 61G005 120 2	49	C091 61N006 120 2	48
C091 31K006 200 2	42	C091 31S105 100 2	47	C091 61G005 130 2	49	C091 61N006 130 2	48
C091 31K006 201 2	42	C091 31S105 200 2	47	C091 61G005 210 2	49	C091 61N006 210 2	48
C091 31K007 100 2	42	C091 31S107 100 2	47	C091 61G005 220 2	49	C091 61N006 220 2	48
C091 31K007 101 2	42	C091 31S107 200 2	47	C091 61G005 230 2	49	C091 61N006 230 2	48
C091 31K007 200 2	42	C091 31T003 100 2	51	C091 61G006 110 2	49	C091 61N007 110 2	48
C091 31K007 201 2	42	C091 31T003 200 2	51	C091 61G006 120 2	49	C091 61N007 120 2	48
C091 31K008 100 2	42	C091 31T004 100 2	51	C091 61G006 130 2	49	C091 61N007 130 2	48
C091 31K008 101 2	42	C091 31T004 200 2	51	C091 61G006 210 2	49	C091 61N007 210 2	48
C091 31K008 200 2	42	C091 31T005 100 2	51	C091 61G006 220 2	49	C091 61N007 220 2	48
C091 31K008 201 2	42	C091 31T005 200 2	51	C091 61G006 230 2	49	C091 61N007 230 2	48
C091 31K012 100 2	42	C091 31T006 100 2	51	C091 61G007 110 2	49	C091 61N008 110 2	48
C091 31K012 101 2	42	C091 31T006 200 2	51	C091 61G007 120 2	49	C091 61N008 120 2	48
C091 31K012 200 2	42	C091 31T007 100 2	51	C091 61G007 130 2	49	C091 61N008 130 2	48
C091 31K012 201 2	42	C091 31T007 200 2	51	C091 61G007 210 2	49	C091 61N008 210 2	48
C091 31K014 100 2	42	C091 31T008 100 2	51	C091 61G007 220 2	49	C091 61N008 220 2	48
C091 31K014 101 2	42	C091 31T008 200 2	51	C091 61G007 230 2	49	C091 61N008 230 2	48
C091 31K014 200 2	42	C091 31T012 100 2	51	C091 61G007 230 2	49	C091 61N012 110 2	48
C091 31K014 201 2	42	C091 31T012 200 2	51	C091 61G008 110 2	49	C091 61 N012 120 2	48
C091 31K105 100 2	42	C091 31T014 100 2	51	C091 61G008 120 2	49	C091 61N012 130 2	48
C091 31K105 101 2	42	C091 31T014 200 2	51	C091 61G008 130 2	49	C091 61N012 210 2	48
C091 31K105 200 2	42	C091 31T105 100 2	51	C091 61G008 210 2	49	C091 61N012 220 2	48
C091 31K105 201 2	42	C091 31T105 200 2	51	C091 61G008 220 2	49	C091 61N012 230 2	48
C091 31K107 100 2	42	C091 31T107 100 2	51	C091 61G008 230 2	49	C091 61N014 110 2	48
C091 31K107 101 2	42	C091 31T107 200 2	51	C091 61G012 110 2	49	C091 61N014 120 2	48
C091 31K107 200 2	42	C091 31W003 100 2	46	C091 61G012 210 2	49	C091 61N014 130 2	48
C091 31K107 201 2	42	C091 31W003 200 2	46	C091 61G012 220 2	49	C091 61N014 210 2	48
C091 31N003 100 2	48	C091 31W004 100 2	46	C091 61G012 230 2	49	C091 61N014 220 2	48
C091 31N003 200 2	48	C091 31W004 200 2	46	C091 61G014 110 2	49	C091 61N014 230 2	48
C091 31N004 100 2	48	C091 31W005 100 2	46	C091 61G014 210 2	49	C091 61N105 110 2	48
C091 31N004 200 2	48	C091 31W005 200 2	46	C091 61G014 220 2	49	C091 61N105 120 2	48
C091 31N005 100 2	48	C091 31W006 100 2	46	C091 61G014 230 2	49	C091 61N105 130 2	48
C091 31N005 200 2	48	C091 31W006 200 2	46	C091 61G105 110 2	49	C091 61N105 210 2	48
C091 31N006 100 2	48	C091 31W007 100 2	46	C091 61G105 120 2	49	C091 61N105 220 2	48
C091 31N006 200 2	48	C091 31W007 200 2	46	C091 61G105 130 2	49	C091 61N105 230 2	48
C091 31N007 100 2	48	C091 31W008 100 2	46	C091 61G105 210 2	49	C091 61N107 110 2	48
C091 31N007 200 2	48	C091 31W008 200 2	46	C091 61G105 220 2	49	C091 61N107 120 2	48
C091 31N008 100 2	48	C091 31W012 100 2	46	C091 61G105 230 2	49	C091 61N107 130 2	48
C091 31N008 200 2	48	C091 31W012 200 2	46	C091 61G107 110 2	49	C091 61N107 210 2	48
C091 31N012 100 2	48	C091 31W014 100 2	46	C091 61G107 120 2	49	C091 61N107 220 2	48
C091 31N012 200 2	48	C091 31W014 200 2	46	C091 61G107 130 2	49	C091 61N107 230 2	48
C091 31N014 100 2	48	C091 31W105 100 2	46	C091 61G107 210 2	49	FH 0200 0911	57
C091 31N014 200 2	48	C091 31W105 200 2	46	C091 61G107 220 2	49	FH 0200 0912	57
C091 31N105 100 2	48	C091 31W107 100 2	46	C091 61N003 110 2	48	FH 0300 091	57
C091 31N105 200 2	48	C091 31W107 200 2	46	C091 61N003 120 2	48	FH 0400 091	57
C091 31N107 100 2	48	C091 51G008 100 2	50	C091 61N003 130 2	48	HN01 010 0158 (1)	56
C091 31N107 200 2	48	C091 51G008 150 2	50	C091 61N003 210 2	48	HN01 010 0158 (2)	56
C091 31S003 100 2	47	C091 51G008 200 2	50	C091 61N003 220 2	48	HN01 015 0046 (1)	56
C091 31S003 200 2	47	C091 51G008 250 2	50	C091 61N003 230 2	48	HN01 015 0046 (2)	56
C091 31S004 100 2	47	C091 61G003 110 2	49	C091 61N004 110 2	48	HN01 015 0047 (1)	56
C091 31S004 200 2	47	C091 61G003 120 2	49	C091 61N004 120 2	48	HN01 015 0047 (2)	56
C091 31S005 100 2	47	C091 61G003 130 2	49	C091 61N004 130 2	48	HN01 015 0052 (1)	56
C091 31S005 200 2	47	C091 61G003 210 2	49	C091 61N004 210 2	48	HN01 015 0052 (2)	56
C091 31S006 100 2	47	C091 61G003 220 2	49	C091 61N004 220 2	48	HN02 010 0158 (1)	56
C091 31S006 200 2	47	C091 61G003 230 2	49	C091 61N004 230 2	48	HN02 010 0158 (2)	56

Part Number	Page	Part Number	Page	Part Number	Page	Part Number	Page
HN02 015 0046 (1)	56	T 3260 013	10	T 3274 502	26	T 3300 005	10
HN02 015 0046 (2)	56	T 3260 018	10	T 3274 504	26	T 3300 013	10
HN02 015 0047 (1)	56	T 3260 028	10	T 3274 518	26	T 3300 018	10
HN02 015 0047 (2)	56	T 3260 038	10	T 3274 528	26	T 3300 028	10
HN02 015 0052 (1)	56	T 3260 048	10	T 3274 548	26	T 3300 038	10
HN02 015 0052 (2)	56	T 3260 055	10	T 3274 551	26	T 3300 048	10
N 45 091 000 1	57	T 3260 058	10	T 3274 552	26	T 3300 055	10
T 0422 060 9	57	T 3260 551	10	T 3274 554	26	T 3300 058	10
T 2993 510 9	57	T 3260 552	10	T 3274 951	26	T 3300 551	10
T 2993 511 9	57	T 3260 554	10	T 3274 991	26	T 3300 552	10
T 2993 512 9	57	T 3260 556	10	T 3274 998	26	T 3300 554	10
T 2993 513 9	57	T 3261 001	12	T 3275 005	30	T 3300 556	10
T 3200 001	10	T 3261 002	12	T 3275 055	30	T 3301 001	12
T 3200 002	10	T 3261 004	12	T 3275 058	30	T 3301 002	12
T 3200 004	10	T 3261 005	12	T 3275 501	30	T 3301 004	12
T 3200 005	10	T 3261 013	12	T 3275 502	30	T 3301 005	12
T 3200 013	10	T 3261 018	12	T 3275 504	30	T 3301 013	12
T 3200 018	10	T 3261 028	12	T 3275 518	30	T 3301 018	12
T 3200 028	10	T 3261 038	12	T 3275 528	30	T 3301 028	12
T 3200 038	10	T 3261 048	12	T 3275 548	30	T 3301 038	12
T 3200 048	10	T 3261 055	12	T 3275 551	30	T 3301 048	12
T 3200 055	10	T 3261 058	12	T 3275 552	30	T 3301 055	12
T 3200 058	10	T 3261 551	12	T 3275 554	30	T 3301 058	12
T 3200 551	10	T 3261 552	12	T 3275 951	30	T 3301 551	12
T 3200 552	10	T 3261 554	12	T 3275 991	30	T 3301 552	12
T 3200 554	10	T 3261 556	12	T 3276 500	34	T 3301 554	12
T 3200 556	10	T 3262 000	14	T 3276 518	34	T 3301 556	12
T 3201 001	12	T 3262 018	14	T 3276 550	34	T 3302 000	14
T 3201 002	12	T 3262 100	15	T 3277 000	35	T 3302 018	14
T 3201 004	12	T 3262 118	15	T 3277 018	35	T 3302 100	15
T 3201 005	12	T 3262 150	15	T 3277 050	35	T 3302 118	15
T 3201 013	12	T 3262 300	14	T 3277 100	36	T 3302 150	15
T 3201 018	12	T 3262 304	14	T 3277 118	36	T 3302 300	14
T 3201 028	12	T 3262 400	15	T 3277 150	36	T 3302 304	14
T 3201 038	12	T 3262 404	15	T 3277 500	35	T 3302 400	15
T 3201 048	12	T 3262 420	15	T 3277 518	35	T 3302 404	15
T 3201 055	12	T 3262 430	15	T 3277 550	35	T 3302 420	15
T 3201 058	12	T 3262 550	14	T 3277 600	37	T 3302 430	15
T 3201 551	12	T 3263 000	18	T 3277 900	37	T 3302 550	14
T 3201 552	12	T 3263 018	18	T 3278 501	32	T 3303 000	18
T 3201 554	12	T 3263 100	19	T 3278 502	32	T 3303 018	18
T 3201 556	12	T 3263 118	19	T 3278 504	32	T 3303 100	19
T 3202 000	14	T 3263 150	19	T 3278 518	32	T 3303 118	19
T 3202 018	14	T 3263 300	18	T 3278 528	32	T 3303 150	19
T 3202 100	15	T 3263 304	18	T 3278 548	32	T 3303 300	18
T 3202 118	15	T 3263 320	18	T 3278 551	32	T 3303 304	18
T 3202 150	15	T 3263 330	18	T 3278 552	32	T 3303 320	18
T 3202 550	14	T 3263 400	19	T 3278 554	32	T 3303 330	18
T 3203 000	18	T 3263 404	19	T 3278 951	32	T 3303 400	19
T 3203 018	18	T 3263 420	19	T 3278 991	32	T 3303 404	19
T 3203 100	19	T 3263 424	19	T 3279 501	28	T 3303 420	19
T 3203 118	19	T 3263 430	19	T 3279 502	28	T 3303 424	19
T 3203 150	19	T 3263 434	19	T 3279 504	28	T 3303 430	19
T 3203 300	18	T 3263 550	18	T 3279 518	28	T 3303 434	19
T 3203 304	18	T 3263 900	20	T 3279 528	28	T 3303 550	18
T 3203 400	19	T 3271 500	35	T 3279 548	28	T 3321 500	35
T 3203 404	19	T 3271 518	35	T 3279 551	28	T 3321 518	35
T 3203 550	18	T 3271 550	35	T 3279 552	28	T 3321 550	35
T 3260 001	10	T 3274 005	26	T 3279 554	28	T 3324 005	26
T 3260 002	10	T 3274 055	26	T 3300 001	10	T 3324 055	26
T 3260 004	10	T 3274 058	26	T 3300 002	10	T 3324 058	26
T 3260 005	10	T 3274 501	26	T 3300 004	10	T 3324 501	26

Part Number	Page	Part Number	Page	Part Number	Page	Part Number	Page
T 3324 502	26	T 3356 048	10	T 3360 554	10	T 3374 528	26
T 3324 504	26	T 3356 055	10	T 3360 556	10	T 3374 548	26
T 3324 518	26	T 3356 058	10	T 3361 001	12	T 3374 551	26
T 3324 528	26	T 3356 551	10	T 3361 002	12	T 3374 552	26
T 3324 548	26	T 3356 552	10	T 3361 004	12	T 3374 554	26
T 3324 551	26	T 3356 554	10	T 3361 005	12	T 3374 951	26
T 3324 552	26	T 3356 556	10	T 3361 010	12	T 3374 991	26
T 3324 554	26	T 3357 004	12	T 3361 013	12	T 3374 998	26
T 3324 951	26	T 3357 005	12	T 3361 018	12	T 3375 005	30
T 3324 991	26	T 3357 018	12	T 3361 020	12	T 3375 055	30
T 3324 998	26	T 3357 028	12	T 3361 028	12	T 3375 058	30
T 3325 005	30	T 3357 038	12	T 3361 038	12	T 3375 501	30
T 3325 055	30	T 3357 048	12	T 3361 048	12	T 3375 502	30
T 3325 058	30	T 3357 055	12	T 3361 055	12	T 3375 504	30
T 3325 501	30	T 3357 058	12	T 3361 058	12	T 3375 518	30
T 3325 502	30	T 3357 551	12	T 3361 130	12	T 3375 528	30
T 3325 504	30	T 3357 552	12	T 3361 551	12	T 3375 548	30
T 3325 518	30	T 3357 554	12	T 3361 552	12	T 3375 551	30
T 3325 528	30	T 3357 556	12	T 3361 554	12	T 3375 552	30
T 3325 548	30	T 3358 018	14	T 3361 556	12	T 3375 554	30
T 3325 551	30	T 3358 100	15	T 3362 000	14	T 3375 951	30
T 3325 552	30	T 3358 118	15	T 3362 010	14	T 3375 991	30
T 3325 554	30	T 3358 150	15	T 3362 018	14	T 3376 500	34
T 3325 951	30	T 3358 300	14	T 3362 100	15	T 3376 518	34
T 3325 991	30	T 3358 304	14	T 3362 118	15	T 3376 550	34
T 3326 500	34	T 3358 400	15	T 3362 150	15	T 3377 000	35
T 3326 518	34	T 3358 404	15	T 3362 300	14	T 3377 018	35
T 3326 550	34	T 3358 420	15	T 3362 304	14	T 3377 050	35
T 3327 000	35	T 3358 430	15	T 3362 400	15	T 3377 100	36
T 3327 018	35	T 3358 550	14	T 3362 404	15	T 3377 118	36
T 3327 050	35	T 3359 018	18	T 3362 420	15	T 3377 150	36
T 3327 100	36	T 3359 100	19	T 3362 430	15	T 3377 500	35
T 3327 118	36	T 3359 118	19	T 3362 550	14	T 3377 518	35
T 3327 150	36	T 3359 150	19	T 3363 000	18	T 3377 550	35
T 3327 500	35	T 3359 300	18	T 3363 010	18	T 3377 600	37
T 3327 518	35	T 3359 304	18	T 3363 018	18	T 3378 501	32
T 3327 550	35	T 3359 320	18	T 3363 100	19	T 3378 502	32
T 3328 501	32	T 3359 330	18	T 3363 118	19	T 3378 504	32
T 3328 502	32	T 3359 400	19	T 3363 150	19	T 3378 518	32
T 3328 504	32	T 3359 404	19	T 3363 218	21	T 3378 528	32
T 3328 518	32	T 3359 420	19	T 3363 300	18	T 3378 548	32
T 3328 528	32	T 3359 424	19	T 3363 304	18	T 3378 551	32
T 3328 548	32	T 3359 430	19	T 3363 320	18	T 3378 552	32
T 3328 551	32	T 3359 434	19	T 3363 330	18	T 3378 554	32
T 3328 552	32	T 3359 550	18	T 3363 400	19	T 3378 951	32
T 3328 554	32	T 3359 900	20	T 3363 404	19	T 3378 991	32
T 3328 951	32	T 3360 001	10	T 3363 420	19	T 3379 501	28
T 3328 991	32	T 3360 002	10	T 3363 424	19	T 3379 502	28
T 3329 501	28	T 3360 004	10	T 3363 430	19	T 3379 504	28
T 3329 502	28	T 3360 005	10	T 3363 434	19	T 3379 518	28
T 3329 504	28	T 3360 010	10	T 3363 550	18	T 3379 528	28
T 3329 518	28	T 3360 013	10	T 3363 902	20	T 3379 548	28
T 3329 528	28	T 3360 018	10	T 3371 500	35	T 3379 551	28
T 3329 548	28	T 3360 020	10	T 3371 518	35	T 3379 552	28
T 3329 551	28	T 3360 028	10	T 3371 550	35	T 3379 554	28
T 3329 552	28	T 3360 038	10	T 3374 005	26	T 3391 500	35
T 3329 554	28	T 3360 048	10	T 3374 055	26	T 3391 518	35
T 3356 004	10	T 3360 055	10	T 3374 058	26	T 3391 550	35
T 3356 005	10	T 3360 058	10	T 3374 501	26	T 3394 005	26
T 3356 018	10	T 3360 130	10	T 3374 502	26	T 3394 055	26
T 3356 028	10	T 3360 551	10	T 3374 504	26	T 3394 058	26
T 3356 038	10	T 3360 552	10	T 3374 518	26	T 3394 501	26

Part Number	Page	Part Number	Page	Part Number	Page	Part Number	Page
T 3394 502	26	T 3400 551	10	T 3424 552	26	T 3434 528	26
T 3394 504	26	T 3400 552	10	T 3424 554	26	T 3434 548	26
T 3394 518	26	T 3400 554	10	T 3424 951	26	T 3434 551	26
T 3394 528	26	T 3400 556	10	T 3424 991	26	T 3434 552	26
T 3394 548	26	T 3401 001	12	T 3424 998	26	T 3434 554	26
T 3394 551	26	T 3401 002	12	T 3425 005	30	T 3434 951	26
T 3394 552	26	T 3401 004	12	T 3425 055	30	T 3434 991	26
T 3394 554	26	T 3401 005	12	T 3425 058	30	T 3434 998	26
T 3394 991	26	T 3401 013	12	T 3425 501	30	T 3435 005	30
T 3394 998	26	T 3401 018	12	T 3425 502	30	T 3435 055	30
T 3395 005	30	T 3401 028	12	T 3425 504	30	T 3435 058	30
T 3395 055	30	T 3401 038	12	T 3425 518	30	T 3435 501	30
T 3395 058	30	T 3401 048	12	T 3425 528	30	T 3435 502	30
T 3395 501	30	T 3401 055	12	T 3425 548	30	T 3435 504	30
T 3395 502	30	T 3401 058	12	T 3425 551	30	T 3435 518	30
T 3395 504	30	T 3401 551	12	T 3425 552	30	T 3435 528	30
T 3395 518	30	T 3401 552	12	T 3425 554	30	T 3435 548	30
T 3395 528	30	T 3401 554	12	T 3425 951	30	T 3435 551	30
T 3395 548	30	T 3401 556	12	T 3425 991	30	T 3435 552	30
T 3395 551	30	T 3402 000	14	T 3426 500	34	T 3435 554	30
T 3395 552	30	T 3402 018	14	T 3426 518	34	T 3435 951	30
T 3395 554	30	T 3402 100	15	T 3426 550	34	T 3435 991	30
T 3396 500	34	T 3402 118	15	T 3427 000	35	T 3436 500	34
T 3396 518	34	T 3402 150	15	T 3427 018	35	T 3436 518	34
T 3396 550	34	T 3402 300	14	T 3427 050	35	T 3436 550	34
T 3397 100	36	T 3402 304	14	T 3427 100	36	T 3437 000	35
T 3397 118	36	T 3402 400	15	T 3427 118	36	T 3437 018	35
T 3397 150	36	T 3402 404	15	T 3427 150	36	T 3437 050	35
T 3397 500	35	T 3402 420	15	T 3427 500	35	T 3437 100	36
T 3397 518	35	T 3402 430	15	T 3427 518	35	T 3437 118	36
T 3397 550	35	T 3402 550	14	T 3427 550	35	T 3437 150	36
T 3397 600	37	T 3403 000	18	T 3427 600	37	T 3437 500	35
T 3397 900	37	T 3403 018	18	T 3428 501	32	T 3437 518	35
T 3398 501	32	T 3403 100	19	T 3428 502	32	T 3437 550	35
T 3398 502	32	T 3403 118	19	T 3428 504	32	T 3438 501	32
T 3398 504	32	T 3403 150	19	T 3428 518	32	T 3438 502	32
T 3398 518	32	T 3403 218	21	T 3428 528	32	T 3438 504	32
T 3398 528	32	T 3403 300	18	T 3428 548	32	T 3438 518	32
T 3398 548	32	T 3403 304	18	T 3428 551	32	T 3438 528	32
T 3398 551	32	T 3403 320	18	T 3428 552	32	T 3438 548	32
T 3398 552	32	T 3403 330	18	T 3428 554	32	T 3438 551	32
T 3398 554	32	T 3403 400	19	T 3428 951	32	T 3438 552	32
T 3399 501	28	T 3403 404	19	T 3428 991	32	T 3438 554	32
T 3399 502	28	T 3403 420	19	T 3429 501	28	T 3438 951	32
T 3399 504	28	T 3403 424	19	T 3429 502	28	T 3438 991	32
T 3399 518	28	T 3403 430	19	T 3429 504	28	T 3439 501	28
T 3399 528	28	T 3403 434	19	T 3429 518	28	T 3439 502	28
T 3399 548	28	T 3403 550	18	T 3429 528	28	T 3439 504	28
T 3399 551	28	T 3403 902	20	T 3429 548	28	T 3439 518	28
T 3399 552	28	T 3421 500	35	T 3429 551	28	T 3439 528	28
T 3399 554	28	T 3421 518	35	T 3429 552	28	T 3439 548	28
T 3400 001	10	T 3421 550	35	T 3429 554	28	T 3439 551	28
T 3400 002	10	T 3424 005	26	T 3431 500	35	T 3439 552	28
T 3400 004	10	T 3424 055	26	T 3431 518	35	T 3439 554	28
T 3400 005	10	T 3424 058	26	T 3431 550	35	T 3441 500	35
T 3400 013	10	T 3424 501	26	T 3434 005	26	T 3441 518	35
T 3400 018	10	T 3424 502	26	T 3434 055	26	T 3441 550	35
T 3400 028	10	T 3424 504	26	T 3434 058	26	T 3444 005	26
T 3400 038	10	T 3424 518	26	T 3434 501	26	T 3444 055	26
T 3400 048	10	T 3424 528	26	T 3434 502	26	T 3444 058	26
T 3400 055	10	T 3424 548	26	T 3434 504	26	T 3444 501	26
T 3400 058	10	T 3424 551	26	T 3434 518	26	T 3444 502	26

Part Number	Page	Part Number	Page	Part Number	Page	Part Number	Page
T 3444 504	26	T 3475 556	10	T 3485 005	12	T 3505 028	12
T 3444 518	26	T 3476 001	12	T 3485 013	12	T 3505 038	12
T 3444 528	26	T 3476 002	12	T 3485 018	12	T 3505 048	12
T 3444 548	26	T 3476 004	12	T 3485 028	12	T 3505 055	12
T 3444 551	26	T 3476 005	12	T 3485 038	12	T 3505 058	12
T 3444 552	26	T 3476 013	12	T 3485 048	12	T 3505 551	12
T 3444 554	26	T 3476 018	12	T 3485 055	12	T 3505 552	12
T 3444 951	26	T 3476 028	12	T 3485 058	12	T 3505 554	12
T 3445 005	30	T 3476 038	12	T 3485 551	12	T 3505 556	12
T 3445 055	30	T 3476 048	12	T 3485 552	12	T 3506 000	14
T 3445 058	30	T 3476 055	12	T 3485 554	12	T 3506 018	14
T 3445 501	30	T 3476 058	12	T 3485 556	12	T 3506 100	15
T 3445 502	30	T 3476 551	12	T 3486 000	14	T 3506 118	15
T 3445 504	30	T 3476 552	12	T 3486 018	14	T 3506 150	15
T 3445 518	30	T 3476 554	12	T 3486 100	15	T 3506 300	14
T 3445 528	30	T 3476 556	12	T 3486 118	15	T 3506 304	14
T 3445 548	30	T 3477 000	14	T 3486 150	15	T 3506 400	15
T 3445 551	30	T 3477 018	14	T 3486 300	14	T 3506 404	15
T 3445 552	30	T 3477 100	15	T 3486 304	14	T 3506 420	15
T 3445 554	30	T 3477 118	15	T 3486 400	15	T 3506 430	15
T 3446 500	34	T 3477 150	15	T 3486 404	15	T 3506 550	14
T 3446 518	34	T 3477 300	14	T 3486 420	15	T 3507 000	18
T 3446 550	34	T 3477 304	14	T 3486 430	15	T 3507 018	18
T 3447 100	36	T 3477 400	15	T 3486 550	14	T 3507 100	19
T 3447 118	36	T 3477 404	15	T 3487 000	18	T 3507 118	19
T 3447 150	36	T 3477 420	15	T 3487 018	18	T 3507 150	19
T 3447 500	35	T 3477 430	15	T 3487 100	19	T 3507 300	18
T 3447 518	35	T 3477 550	14	T 3487 118	19	T 3507 304	18
T 3447 550	35	T 3478 000	18	T 3487 150	19	T 3507 320	18
T 3447 900	37	T 3478 018	18	T 3487 300	18	T 3507 330	18
T 3448 501	32	T 3478 100	19	T 3487 304	18	T 3507 400	19
T 3448 502	32	T 3478 118	19	T 3487 320	18	T 3507 404	19
T 3448 504	32	T 3478 150	19	T 3487 330	18	T 3507 420	19
T 3448 518	32	T 3478 300	18	T 3487 400	19	T 3507 424	19
T 3448 528	32	T 3478 304	18	T 3487 404	19	T 3507 430	19
T 3448 548	32	T 3478 320	18	T 3487 420	19	T 3507 434	19
T 3448 551	32	T 3478 330	18	T 3487 424	19	T 3507 550	18
T 3448 552	32	T 3478 400	19	T 3487 430	19	T 3507 900	20
T 3448 554	32	T 3478 404	19	T 3487 434	19	T 3507 918	20
T 3449 501	28	T 3478 420	19	T 3487 550	18	T 3521 500	35
T 3449 502	28	T 3478 424	19	T 3487 900	20	T 3521 518	35
T 3449 504	28	T 3478 430	19	T 3504 001	10	T 3521 550	35
T 3449 518	28	T 3478 434	19	T 3504 002	10	T 3524 005	26
T 3449 528	28	T 3478 550	18	T 3504 004	10	T 3524 055	26
T 3449 548	28	T 3484 001	10	T 3504 005	10	T 3524 058	26
T 3449 551	28	T 3484 002	10	T 3504 013	10	T 3524 501	26
T 3449 552	28	T 3484 004	10	T 3504 018	10	T 3524 502	26
T 3449 554	28	T 3484 005	10	T 3504 028	10	T 3524 504	26
T 3475 001	10	T 3484 013	10	T 3504 038	10	T 3524 518	26
T 3475 002	10	T 3484 018	10	T 3504 048	10	T 3524 528	26
T 3475 004	10	T 3484 028	10	T 3504 055	10	T 3524 548	26
T 3475 005	10	T 3484 038	10	T 3504 058	10	T 3524 551	26
T 3475 013	10	T 3484 048	10	T 3504 551	10	T 3524 552	26
T 3475 018	10	T 3484 055	10	T 3504 552	10	T 3524 554	26
T 3475 028	10	T 3484 058	10	T 3504 554	10	T 3524 951	26
T 3475 038	10	T 3484 551	10	T 3504 556	10	T 3525 005	30
T 3475 048	10	T 3484 552	10	T 3505 001	12	T 3525 055	30
T 3475 055	10	T 3484 554	10	T 3505 002	12	T 3525 058	30
T 3475 058	10	T 3484 556	10	T 3505 004	12	T 3525 501	30
T 3475 551	10	T 3485 001	12	T 3505 005	12	T 3525 502	30
T 3475 552	10	T 3485 002	12	T 3505 013	12	T 3525 504	30
T 3475 554	10	T 3485 004	12	T 3505 018	12	T 3525 518	30

Part Number	Page	Part Number	Page	Part Number	Page	Part Number	Page
T 3525 528	30	T 3627 500	35	T 3638 100	19	T 3650 001	10
T 3525 548	30	T 3627 518	35	T 3638 118	19	T 3650 002	10
T 3525 551	30	T 3628 501	32	T 3638 150	19	T 3650 004	10
T 3525 552	30	T 3628 502	32	T 3638 300	18	T 3650 005	10
T 3525 554	30	T 3628 504	32	T 3638 304	18	T 3650 013	10
T 3526 500	34	T 3628 518	32	T 3638 400	19	T 3650 020	10
T 3526 518	34	T 3628 528	32	T 3638 404	19	T 3650 024	10
T 3526 550	34	T 3628 548	32	T 3638 420	19	T 3650 038	10
T 3527 100	36	T 3628 551	32	T 3638 424	19	T 3650 055	10
T 3527 118	36	T 3628 552	32	T 3638 430	19	T 3650 058	10
T 3527 150	36	T 3628 554	32	T 3638 434	19	T 3650 551	10
T 3527 500	35	T 3629 501	28	T 3638 550	18	T 3650 552	10
T 3527 518	35	T 3629 502	28	T 3641 500	35	T 3650 554	10
T 3527 900	37	T 3629 504	28	T 3641 518	35	T 3650 556	10
T 3528 501	32	T 3629 518	28	T 3644 005	26	T 3651 000	12
T 3528 502	32	T 3629 528	28	T 3644 055	26	T 3651 001	12
T 3528 504	32	T 3629 548	28	T 3644 058	26	T 3651 002	12
T 3528 518	32	T 3629 551	28	T 3644 501	26	T 3651 004	12
T 3528 528	32	T 3629 552	28	T 3644 502	26	T 3651 005	12
T 3528 548	32	T 3629 554	28	T 3644 504	26	T 3651 013	12
T 3528 551	32	T 3635 000	10	T 3644 518	26	T 3651 020	12
T 3528 552	32	T 3635 001	10	T 3644 522	26	T 3651 038	12
T 3528 554	32	T 3635 002	10	T 3644 528	26	T 3651 044	12
T 3529 501	28	T 3635 004	10	T 3644 548	26	T 3651 055	12
T 3529 502	28	T 3635 005	10	T 3644 551	26	T 3651 058	12
T 3529 504	28	T 3635 013	10	T 3644 554	26	T 3651 551	12
T 3529 518	28	T 3635 020	10	T 3645 005	30	T 3651 552	12
T 3529 528	28	T 3635 024	10	T 3645 058	30	T 3651 554	12
T 3529 548	28	T 3635 038	10	T 3645 501	30	T 3651 556	12
T 3529 551	28	T 3635 055	10	T 3645 502	30	T 3652 000	14
T 3529 552	28	T 3635 058	10	T 3645 504	30	T 3652 001	14
T 3529 554	28	T 3635 551	10	T 3645 518	30	T 3652 100	15
T 3621 500	35	T 3635 552	10	T 3645 528	30	T 3652 110	15
T 3621 518	35	T 3635 554	10	T 3645 548	30	T 3652 150	15
T 3624 005	26	T 3635 556	10	T 3645 551	30	T 3652 300	14
T 3624 055	26	T 3636 000	12	T 3645 552	30	T 3652 304	14
T 3624 058	26	T 3636 001	12	T 3645 554	30	T 3652 400	15
T 3624 501	26	T 3636 002	12	T 3646 500	34	T 3652 404	15
T 3624 502	26	T 3636 004	12	T 3646 518	34	T 3652 550	14
T 3624 504	26	T 3636 005	12	T 3647 100	36	T 3653 000	18
T 3624 518	26	T 3636 013	12	T 3647 118	36	T 3653 004	18
T 3624 528	26	T 3636 020	12	T 3647 500	35	T 3653 100	19
T 3624 548	26	T 3636 038	12	T 3647 518	35	T 3653 118	19
T 3624 551	26	T 3636 044	12	T 3648 501	32	T 3653 150	19
T 3624 552	26	T 3636 055	12	T 3648 502	32	T 3653 300	18
T 3624 554	26	T 3636 058	12	T 3648 504	32	T 3653 304	18
T 3625 005	30	T 3636 551	12	T 3648 518	32	T 3653 400	19
T 3625 055	30	T 3636 552	12	T 3648 528	32	T 3653 404	19
T 3625 058	30	T 3636 554	12	T 3648 548	32	T 3653 420	19
T 3625 501	30	T 3636 556	12	T 3648 551	32	T 3653 424	19
T 3625 502	30	T 3637 000	14	T 3648 552	32	T 3653 430	19
T 3625 504	30	T 3637 001	14	T 3648 554	32	T 3653 434	19
T 3625 518	30	T 3637 100	15	T 3649 501	28	T 3653 550	18
T 3625 528	30	T 3637 110	15	T 3649 502	28	TA 0000	57
T 3625 548	30	T 3637 150	15	T 3649 504	28	TA 0000 502	57
T 3625 551	30	T 3637 300	14	T 3649 518	28	TA 0000 503	57
T 3625 552	30	T 3637 304	14	T 3649 528	28	TA 0000 504	57
T 3625 554	30	T 3637 400	15	T 3649 548	28	TA 0002 091 0001	57
T 3626 500	34	T 3637 404	15	T 3649 551	28	TA 0003 091 0001	57
T 3626 518	34	T 3637 550	14	T 3649 552	28	TA 0012 091 0001	57
T 3627 100	36	T 3638 000	18	T 3649 554	28	TN01 010 0158 (1)	56
T 3627 118	36	T 3638 004	18	T 3650 000	10	TN01 010 0158 (2)	56

Part Number	Page	Part Number	Page	Part Number	Page	Part Number	Page
TN01 015 0046 (1)	56						
TN01 015 0046 (2)	56						
TN01 015 0047 (1)	56						
TN01 015 0047 (2)	56						
TN01 015 0052 (1)	56						
TN01 015 0052 (2)	56						
TN02 010 0158 (1)	56						
TN02 010 0158 (2)	56						
TN02 015 0046 (1)	56						
TN02 015 0046 (2)	56						
TN02 015 0047 (1)	56						
TN02 015 0047 (2)	56						
TN02 015 0052 (1)	56						
TN02 015 0052 (2)	56						
VN01 010 0158 (1)	56						
VN01 010 0158 (2)	56						
VN01 015 0046 (1)	56						
VN01 015 0046 (2)	56						
VN01 015 0047 (1)	56						
VN01 015 0047 (2)	56						
VN01 015 0052 (1)	56						
VN01 015 0052 (2)	56						
VN02 010 0158 (1)	56						
VN02 010 0158 (2)	56						
VN02 015 0046 (1)	56						
VN02 015 0046 (2)	56						
VN02 015 0047 (1)	56						
VN02 015 0047 (2)	56						
VN02 015 0052 (1)	56						
VN02 015 0052 (2)	56						
ZN01 015 0046 (1)	56						
ZN01 015 0046 (2)	56						
ZN01 015 0047 (1)	56						
ZN01 015 0047 (2)	56						
ZN02 015 0046 (1)	56						
ZN02 015 0046 (2)	56						
ZN02 015 0047 (1)	56						
ZN02 015 0047 (2)	56						

International

USA

Amphenol SINE SYSTEMS
44724 Marley Drive Clinton
Township, MI 48036
USA
Telephone: +1-586-465-3131
Fax: +1-586-913-9618

KOREA

Amphenol DAESHIN
558 Sosa, SongNea Bucheon-city
Kyunggi-Do
Korea 420-130
Telephone : +82-32-610-3800
Fax: +82-32-673-2507/665-6219

GERMANY

Amphenol-TUCHEL ELECTRONICS GMBH
August-Haeusser-Strasse 10
74080 Heilbronn
Germany
Telephone +49-7131-929-0
Fax +49-7131-929-486
www.amphenol.de

AUSTRALIA

Amphenol AUSTRALIA PTY LIMITED
2 Fiveways Blvd., Keysborough - Melbourne,
Victoria 3173
Australia
Telephone: +61-3-8796-8888
Fax: +61-3-8796-8801

CHINA

Amphenol TUCHEL ELECTRONICS GMBH
China Branch
20 Tianshan Road
Changzhou 213022
China
Telephone: +86-519-85110301
www.amphenol.info



Important Notice

All technical data have been measured in a laboratory environment and can be different during practical usage of the product. Any product information is for descriptive usage only and not legally binding; particularly the information does not constitute or provide any legal guaranties ("Beschaffensgarantie" or "Haltbarkeitsgarantie").

We reserve the right to change the design due to improvement in quality, development or production requirements. This catalogue must not be used in any form or manner without our prior approval in writing (Copyright Law, Fair Trading Law, Civil Code).

Your engineering sales representative:

Blank area for signature, enclosed by L-shaped corner lines.