

PRODUCT SPECIFICATION

Model No.: FYL-3014UWC1A-UWW

Descriptions:
■ Dice material: InGaN.
■ Emitting Color: Super Bright Warm White.
■ Device Outline: Φ3mm Round Type.
■ Lens Type: Water clear.



CUSTOMER APPROVED SIGNATURES	APPROVED BY	CHECKED BY	PREPARED BY

NINGBO FORYARD OPTOELECTRONICS CO.,LTD.

Add:NO.115 Qixin Road Ningbo Zhejiang China

Zip:315051

Tel: 0086-574-87933652 87927870 87922206

Fax: 0086-574-87927917

E-mail: Sales@foryard.com (General)

[Http://www.foryard.com](http://www.foryard.com)

■ Absolute maximum ratings(Ta=25 ° c)

Parameter	MAX.	Unit
Power Dissipation	90	mW
Peak Forward Current (1/10 Duty Cycle, 0.1ms Pulse Width)	100	mA
Continuous Forward Current	25	mA
Derating Linear From 50°C	0.4	mA/°C
Reverse Voltage	5	V
Operating Temperature Range	-40°C to +85°C	
Storage Temperature Range	-40°C to +100°C	
Lead Soldering Temperature[4mm(.157") From Body]	260°C for 5 Seconds	

■ Electrical and optical characteristics(Ta=25 ° c)

Parameter	Symbol	Min.	Typ.	Max.	Unit	Test Condition
Luminous Intensity	I _v	8000	10000	13000	mcd	I _F =20mA
Viewing Angle	2θ _{1/2}	25	30	35	Deg	
Chromaticity coordinates	X	-	0.42			
	Y		0.43			
Color temperature	CCT	3200	3500	3800	K	
Forward Voltage	V _F	2.8	3.2	3.6	V	
Reverse Current	I _R			10	μA	V _R =5V

■ **Typical Electrical Characteristics Curves**
(25 °c Ambient Temperature Unless Otherwise Noted)

Spectral Reduance

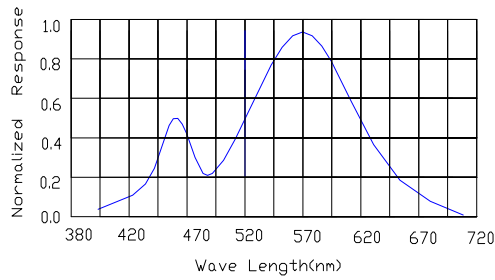

Forward Current Vs Forward Voltage

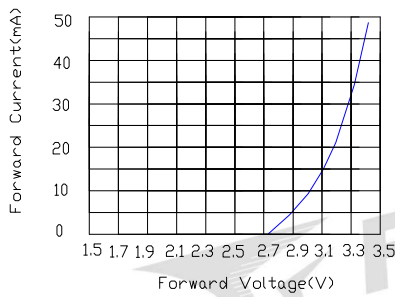

Relative Luminous intensity vs Forward current

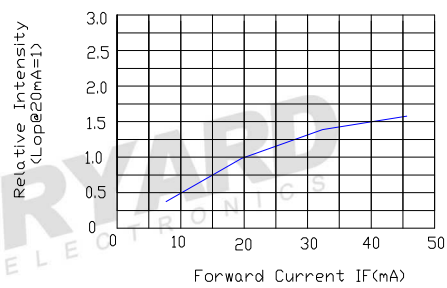

Forward Current Derating Curve

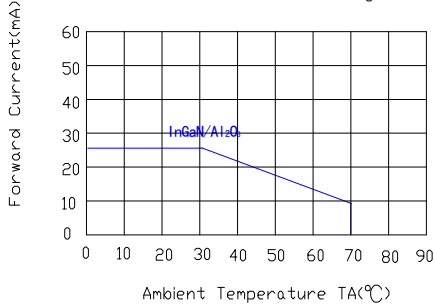

Luminous Intensity Vs. Ambient Temperature

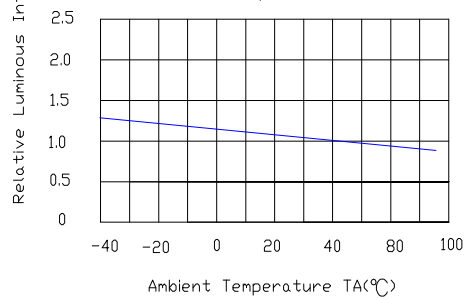

Radiation pattern.

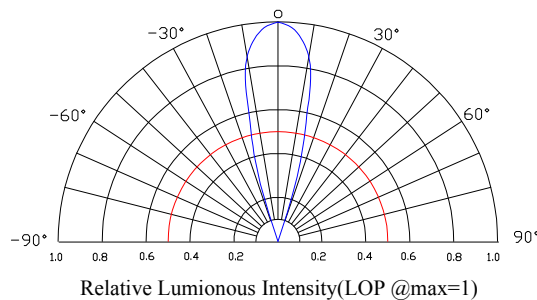

Model. No.	FYL-3014UWC1A-UWW
Rev.	A

■ LAMP PACKING.

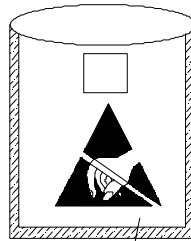
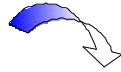

3mm 1000PCS/Polybag

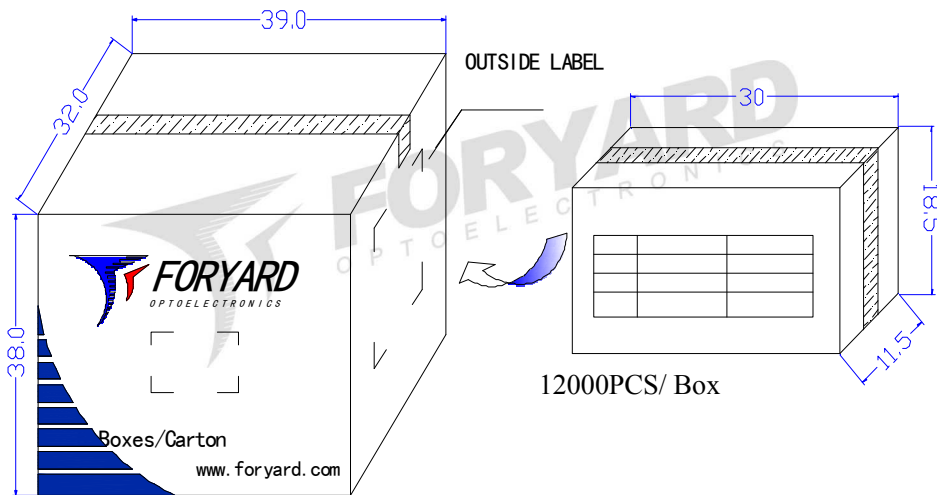
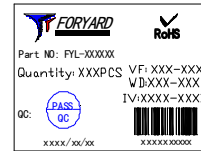

72000PCS/ Carton



OUTSIDE LABEL