

ATTENTION
OBSERVE PRECAUTIONS
FOR HANDLING
ELECTROSTATIC
DISCHARGE
SENSITIVE
DEVICES

HL-798H256WC-MD



Features

- ϕ 4.8 HAT STRAW LAMP LED
- LOW POWER CONSUMPTION.
- WIDE VIEWING ANGLE.
- IDEAL FOR BACKLIGHT、LIGHTING AND INDICATOR.
- PACKAGE:1000PCS / BAG.

Package Dimensions

Description

This devices are made with TS InGaN.

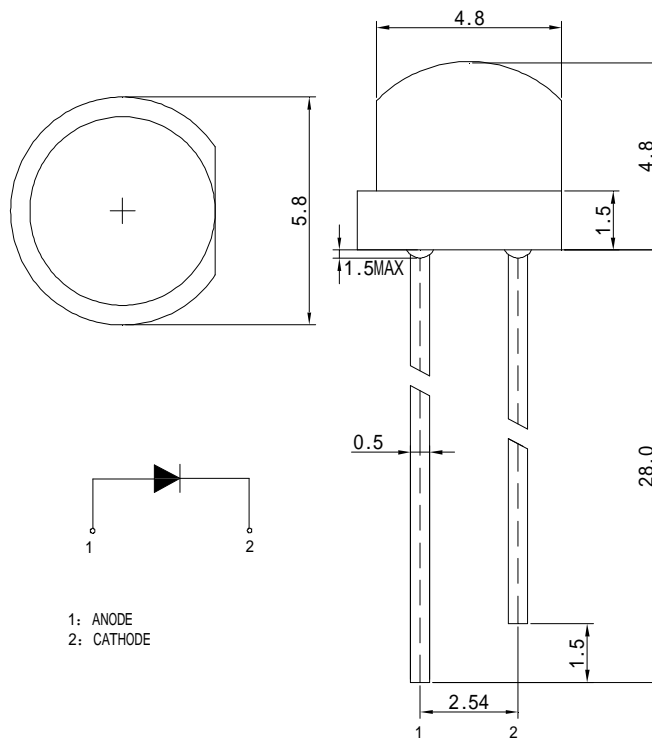

Tolerance Grade	Dimension Tolerance (UNIT:mm)			
	0.5~3	3~6	6~30	30~120
	± 0.1	± 0.2	± 0.3	± 0.5
Chip		Lens Color		
Material	Emitting Color	Water Clear		
InGaN	White			

■ Absolute Maximum Rating

Item	Symbol	Value	Unit
Forward Current	I _F	20	mA
Peak Forward Current*	I _{FP}	100	mA
Reverse Voltage	V _R	5	V
Power Dissipation	P _D	80	mW
Electrostatic discharge	E _{SD}	1000	V
Operation Temperature	T _{opr}	-30~+80	°C
Storage Temperature	T _{stg}	-30~+80	°C
Lead Soldering Temperature*	T _{sol}	Max. 260°C for 5sec Max.	

*I_{FP} Conditions: Pulse Width ≤ 10msec

*T_{sol} Conditions: 3mm from the base of the epoxy bulb

■ Typical Optical/ Electrical Characteristics Ta=25°C

Item	Symbol	Condition	Rank	Min.	Typ.	Max.	Unit
Luminous Intensity	I _v	I _F =20mA	S	1015		1320	mcd
			T	1320		1715	mcd
			U	1715		2230	mcd
Forward Voltage	V _F			2.8	3.2	3.6	V
Viewing Angle	2θ 1/2			--	120	--	deg
Chromaticity coordinates	X				--	0.31	--
	Y			--	0.33	--	Y:±0.025
Recommend Forward Current	I _F (rec)	--		--	--	20	mA
Reverse Current	I _R	V _r =5V		--	--	10	uA

Notes:

Tolerance : V_F ± 0.1V, λ_d ± 2 nm, I_V(φ V) ± 15%, 2θ 1/2 ± 15%

The above color coordinates measurement allowance tolerance ±0.003

Reliability Performance Test Items And Result

Test Classification	Test Item	Test Conditions	Test Duration	Sample Size	AC/RE
Life Test	Room Temperature DC Operating Life Test	$T_a=25^{\circ}\text{C}\pm 5^{\circ}\text{C}$, $I_f=20\text{mA}$	1000hrs	22 pcs	0/1
Environment Test	Thermal Shock Test	$100^{\circ}\text{C}\pm 5^{\circ}\text{C}$ 5min ↑ ↓ $-40^{\circ}\text{C}\pm 5^{\circ}\text{C}$ 5min.	100 cycles	22 pcs	0/1
	Temperature Cycle Test	$100^{\circ}\text{C}\pm 5^{\circ}\text{C}$ 30min ↑ ↓ 5min $-40^{\circ}\text{C}\pm 5^{\circ}\text{C}$ 30min.	100 cycles	22 pcs	0/1
	High Temperature & High Humidity Test	$85^{\circ}\text{C}\pm 5^{\circ}\text{C}/85\% \text{RH}$ $I_f=5\text{mA}$	1000hrs	22 pcs	0/1
	High Temperature Storage	$T_a=100^{\circ}\text{C}\pm 5^{\circ}\text{C}$	1000hrs	22 pcs	0/1
	Low Temperature Storage	$T_a=-40^{\circ}\text{C}\pm 5^{\circ}\text{C}$	1000hrs	22 pcs	0/1
Mechanical Test	Resistance to Soldering Heat	Temp= 260°C max T=5sec max	1times	22 pcs	0/1
	Lead Integrity	Load 2.5N(0.25kgf) $0^{\circ} \sim 90^{\circ} \sim 0^{\circ}$	3times	22 pcs	0/1

Forward Current vs. Ambient Temperature Relative Intensity vs. Ambient Temperature

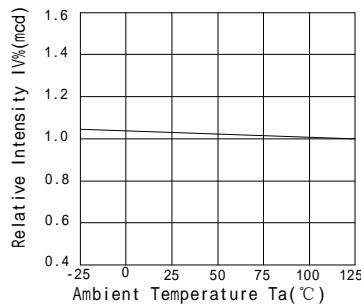
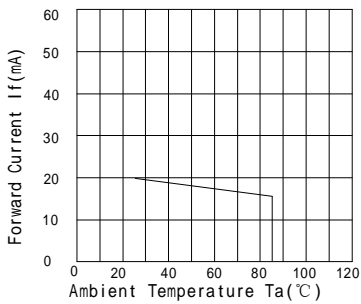

Forward Current vs. Forward Voltage

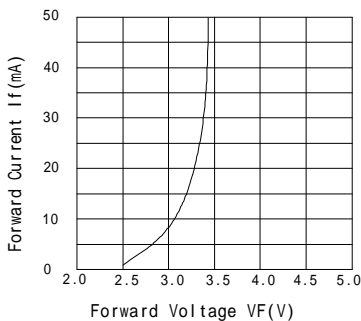

Forward Voltage vs. Ambient Temperature

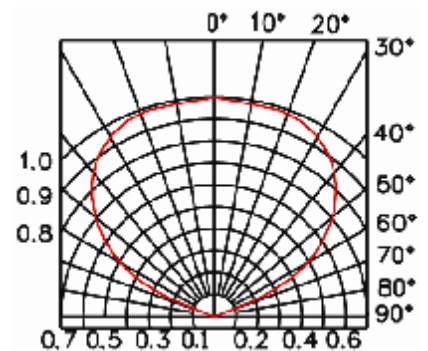
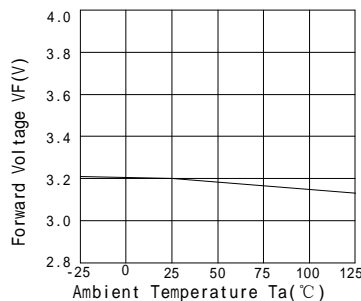

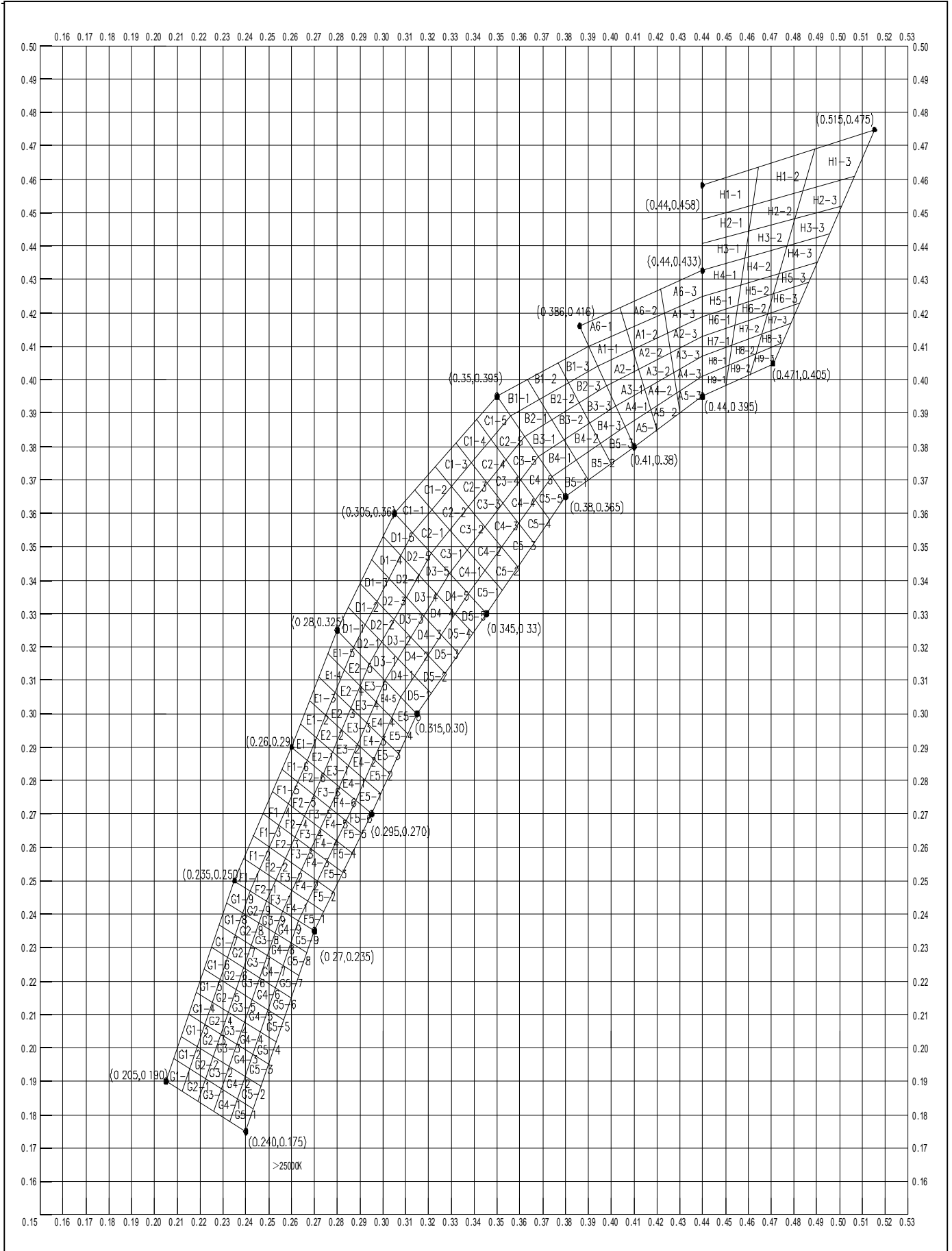

Soldering

1. Manual Of Soldering

The temperature of the iron tip should not be higher than 300°C and Soldering within 3 seconds per solder-land is to be observed.

2. DIP soldering (Wave Soldering):

Preheating: 120°C~150°C, within 120~180 sec.

Operation heating: 245°C ± 5°C within 5 sec. 260°C (Max)

Gradual Cooling (Avoid quenching).

