

DETAILS

Product Number	CA12589_EMILY-WWW
Family	Emily
Type	Assembly
Color	clear
Diameter	26 mm
Height	13,3 mm
Style	round
Optic Material	PMMA
Holder Material	
Fastening	pin, tape
Status	production ready
ROHS Compliant	Yes
Date Updated	9/06/2016



OPTICAL PROPERTIES

LED	Viewing	Light	Effi-	cd/lm	Connector
	Angle	Beam	ciency		
XP-E	58 deg	WWW-class	86 %	1.000	-
XP-G	57 deg	WWW-class	86 %	1.000	-
XP-G2	61 deg	WWW-class	87 %	0.900	-
XP-E2	69 deg	WWW-class	86 %	0.770	-
XP-L	69 deg	WWW-class	82 %	0.680	-
XP-L HI	66 deg	WWW-class	88 %	0.820	-
XHP35 HD	70 deg	WWW-class	82 %	0.710	-
LUXEON A	57 deg	WWW-class	84 %	0.900	-
NVSxx19B/NVSxx19C	54 deg	WWW-class	85 %	1.000	-
NCSxx19B	60 deg	WWW-class	83 %	0.900	-
Oslon Square EC	61 deg	WWW-class	85 %	0.900	-
Z8Y22P	60 deg	WWW-class	92 %	0.930	-

D

C

B

A

INDEX	PART NO	DESCRIPTION	MATERIAL
1			

4

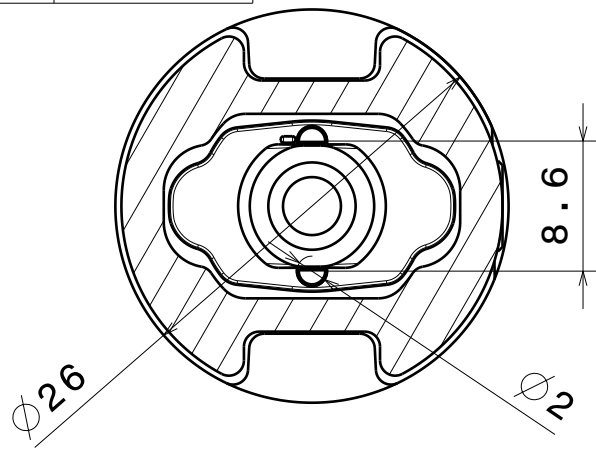

Bottom view

4

3

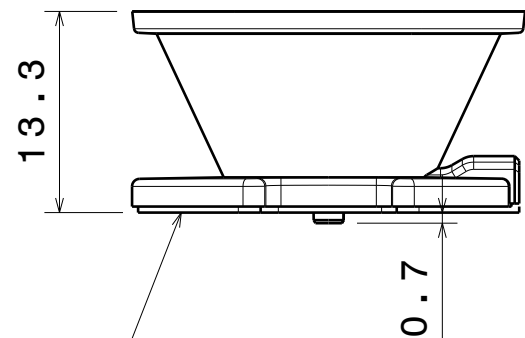

TAPE 0.4mm

Front view
Scale: 2:1

3

2

Materials:
 Lens PMMA
 Tape PU foam with PSA

Tolerances for dimensions:
 0-20mm tolerance value +/-0.1mm
 21-45mm tolerance value +/-0.2mm
 46-90mm tolerance value +/-0.3mm
 91-100mm tolerance value +/-0.4mm
 101-mm tolerance value +/-0.5mm

2

This drawing is our property.
 It can't be reproduced
 or communicated without
 our written agreement.



Ledil Oy
 Salorankatu 10
 FIN 24240 SALO
 Finland

DRAWING TITLE | Part Drawing

DRAWN BY
pv

DATE
27.9.2012

Datasheet EMILY-WWW assy

CHECKED BY
-

DATE
-

SIZE
A4

PART NUMBER
CA12589

REV
001

DESIGNED BY
-

DATE
-

SCALE 1:1

WEIGHT -

SHEET 1/1

1

1

D

A

Luminaire: Ledil Oy CA12589_EMILY-WWW (Cree XP-E 66.5lm @ 250mA) Efficiency=86%
Lamps: 1 x Cree XP-E 66.5lm @ 250mA

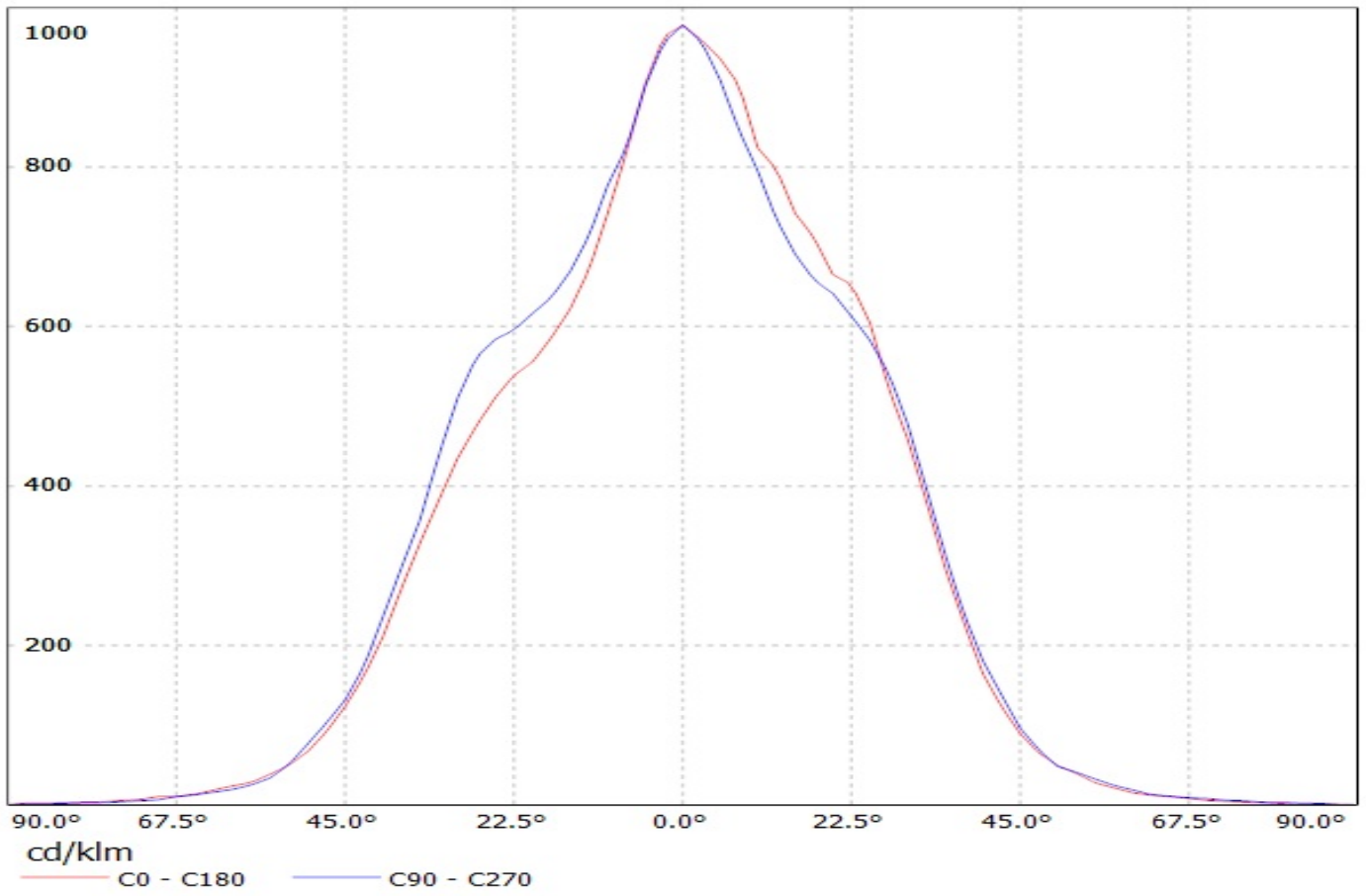

Luminaire: Ledil Oy CA12589_EMILY-WWW (Cree XP-G 58lm @ 250mA) Efficiency=86%
Lamps: 1 x Cree XP-G 58lm @ 250mA

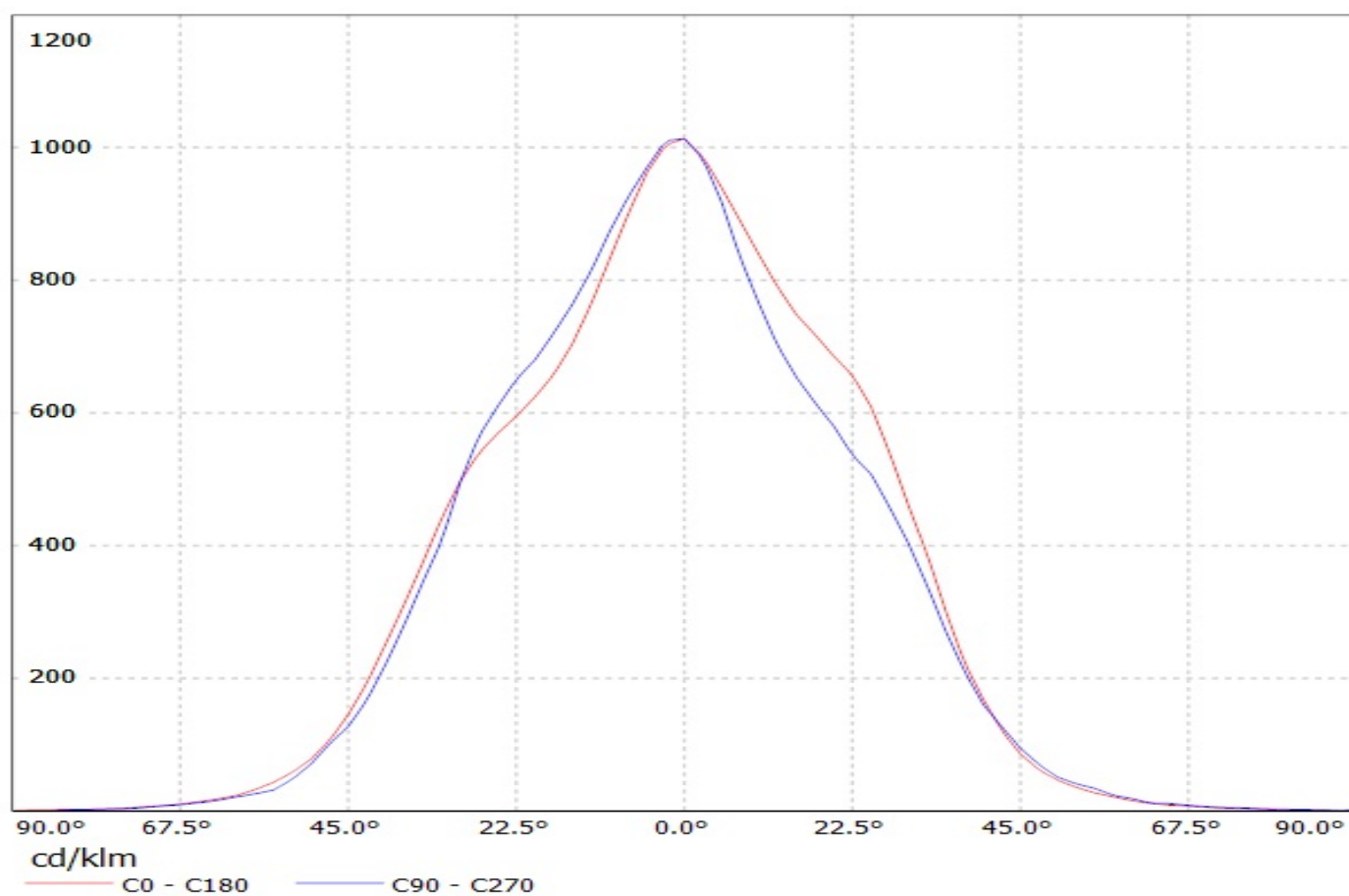

Luminaire: Ledil Oy CA12589_EMILY-WWW (Cree XP-G2 98.8lm @ 250mA) Efficiency=87%
Lamps: 1 x Cree XP-G2 98.8lm @ 250mA

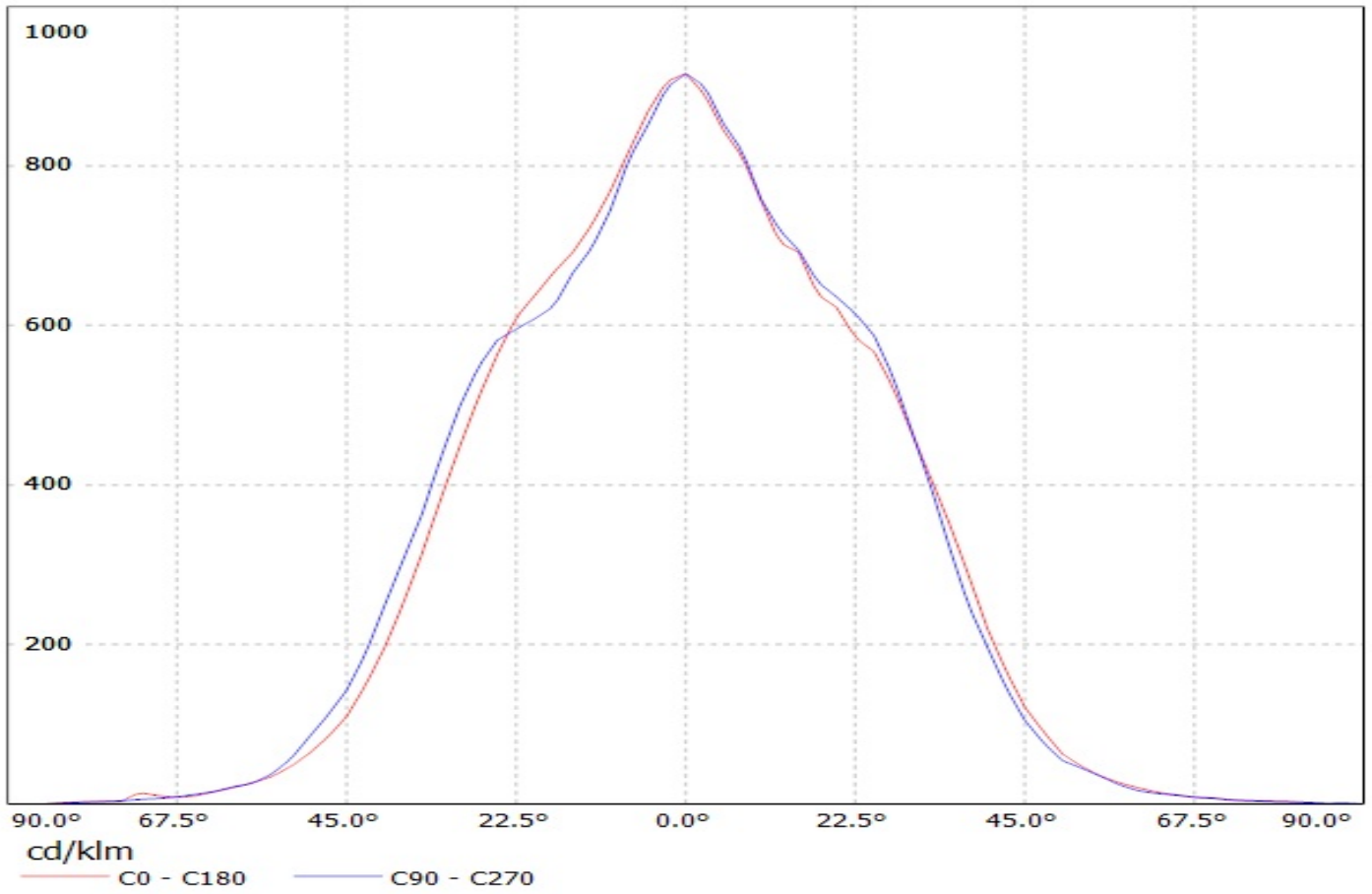

Luminaire: LEDil Oy CA12589_EMILY-WWW_(XP-E2)

Lamps: 1 x Cree XP-E2 (XPEBWT-L1-7B4-Q4-0-01) 78.62lm @ 250mA P=0.8W I=250mA

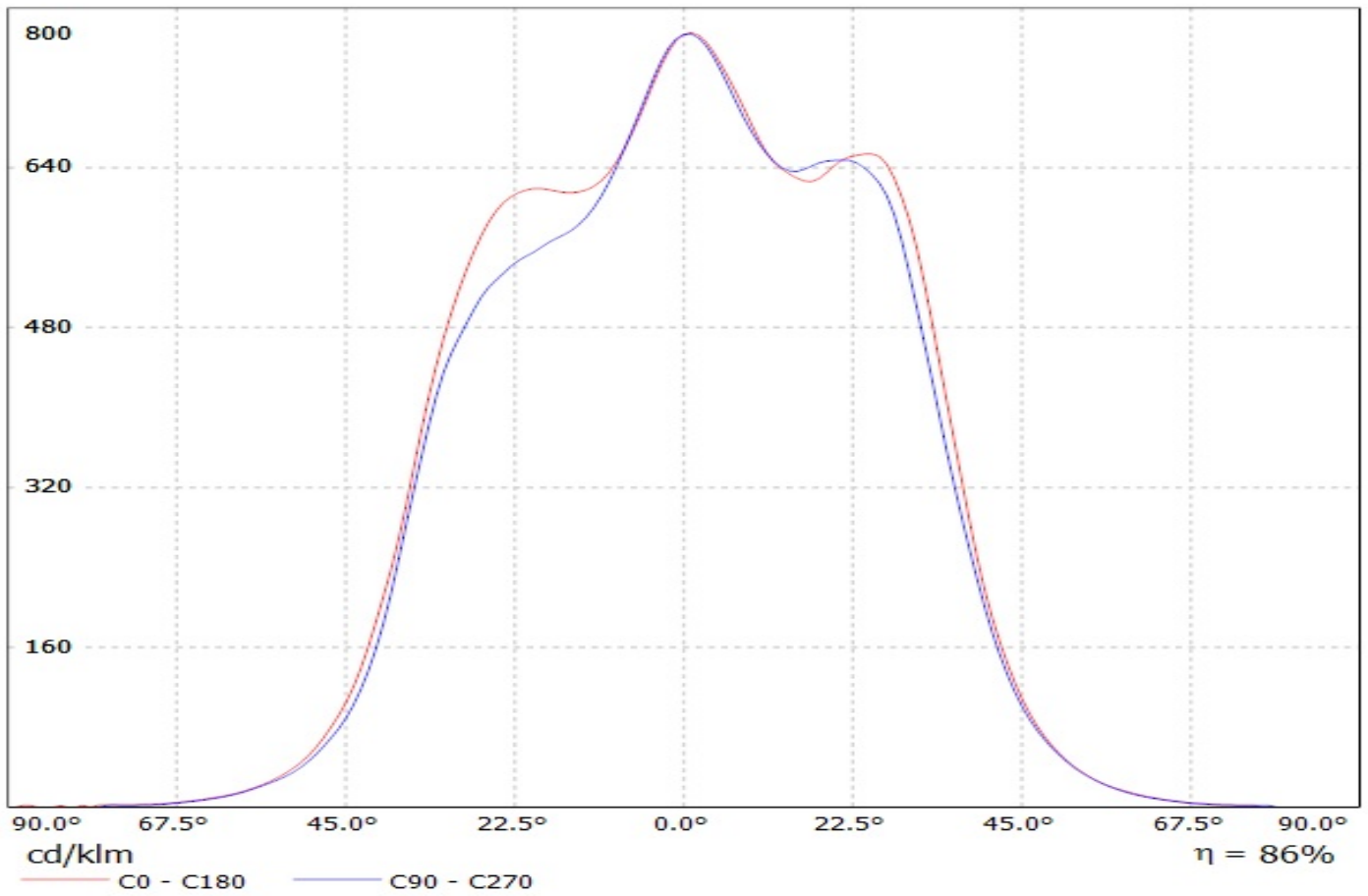

Luminaire: LEDiL Oy CA12589_EMILY-WWW_(XP-L) Eff.82.4%
Lamps: 1 x Cree_XP-L_127.813lm@250mA_P=0.73723W_I=249.9mA

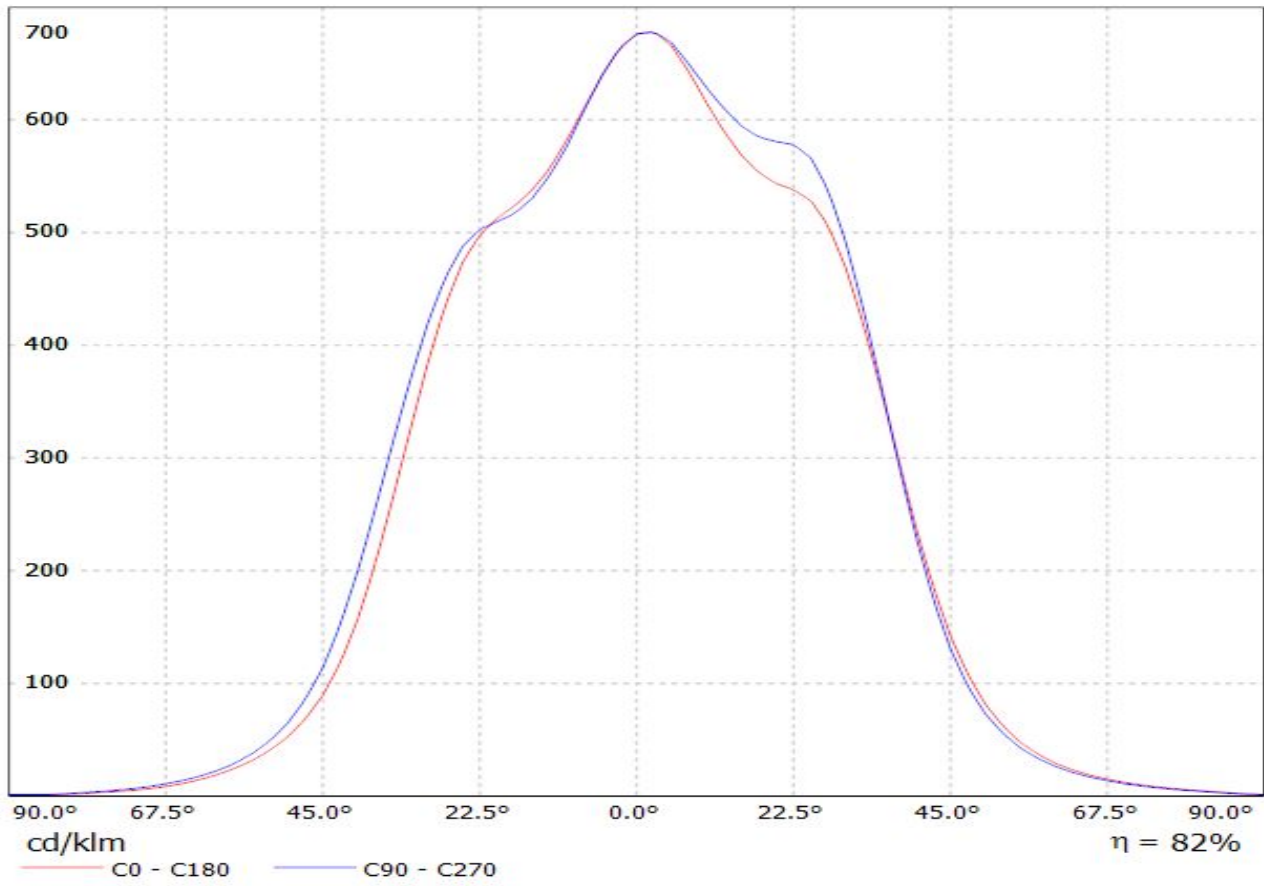

Luminaire: LEDiL Oy CA12589_EMILY-WWW_(XP-L_HI)

Lamps: 1 x Cree_XP-L_HI_114.406lm@250mA_P=0.745352W_I=0.2499A

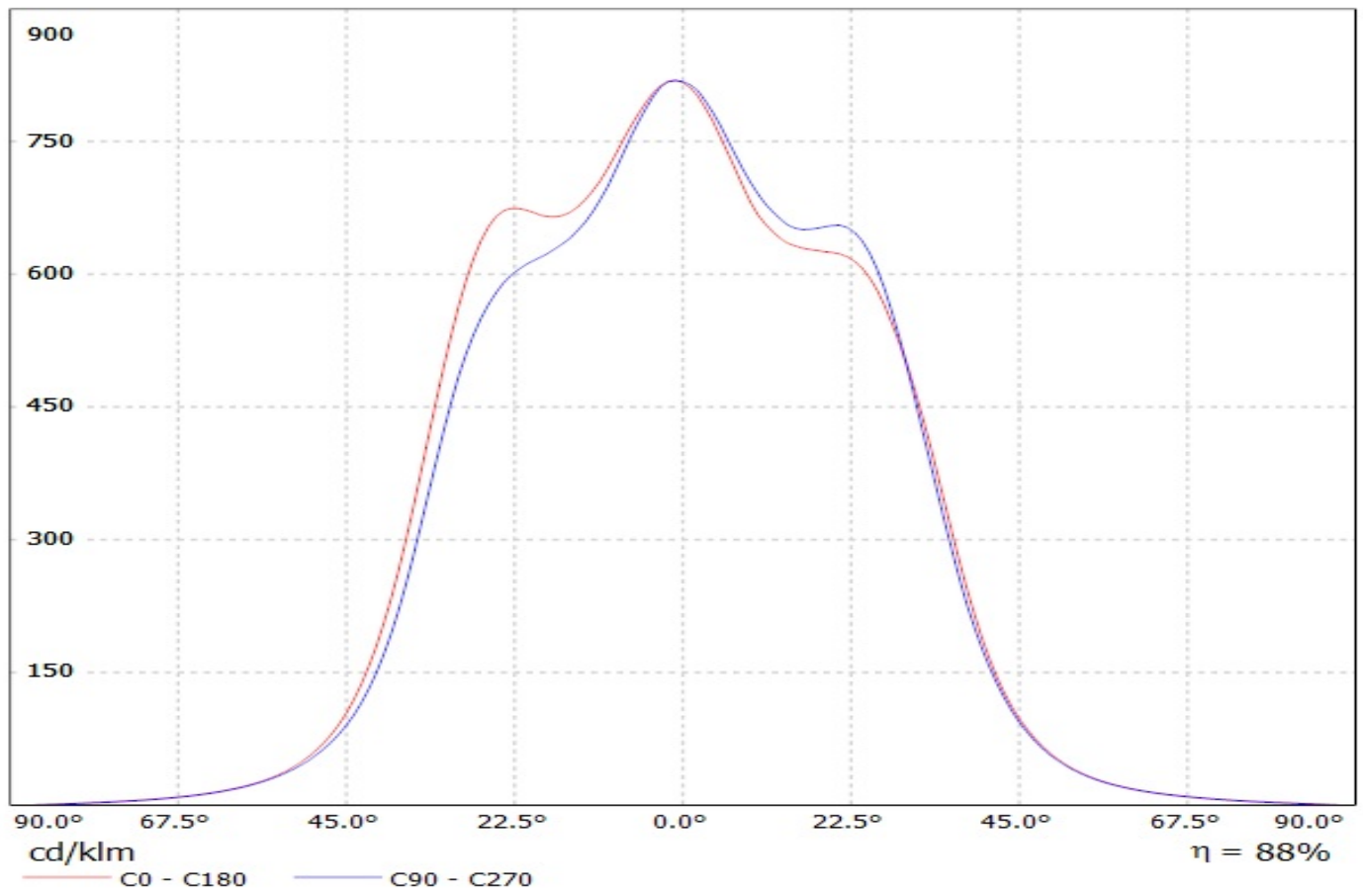

Luminaire: LEDiL Oy
Lamps: 1 x CA12589_EMILY-WWW_(XHP35)

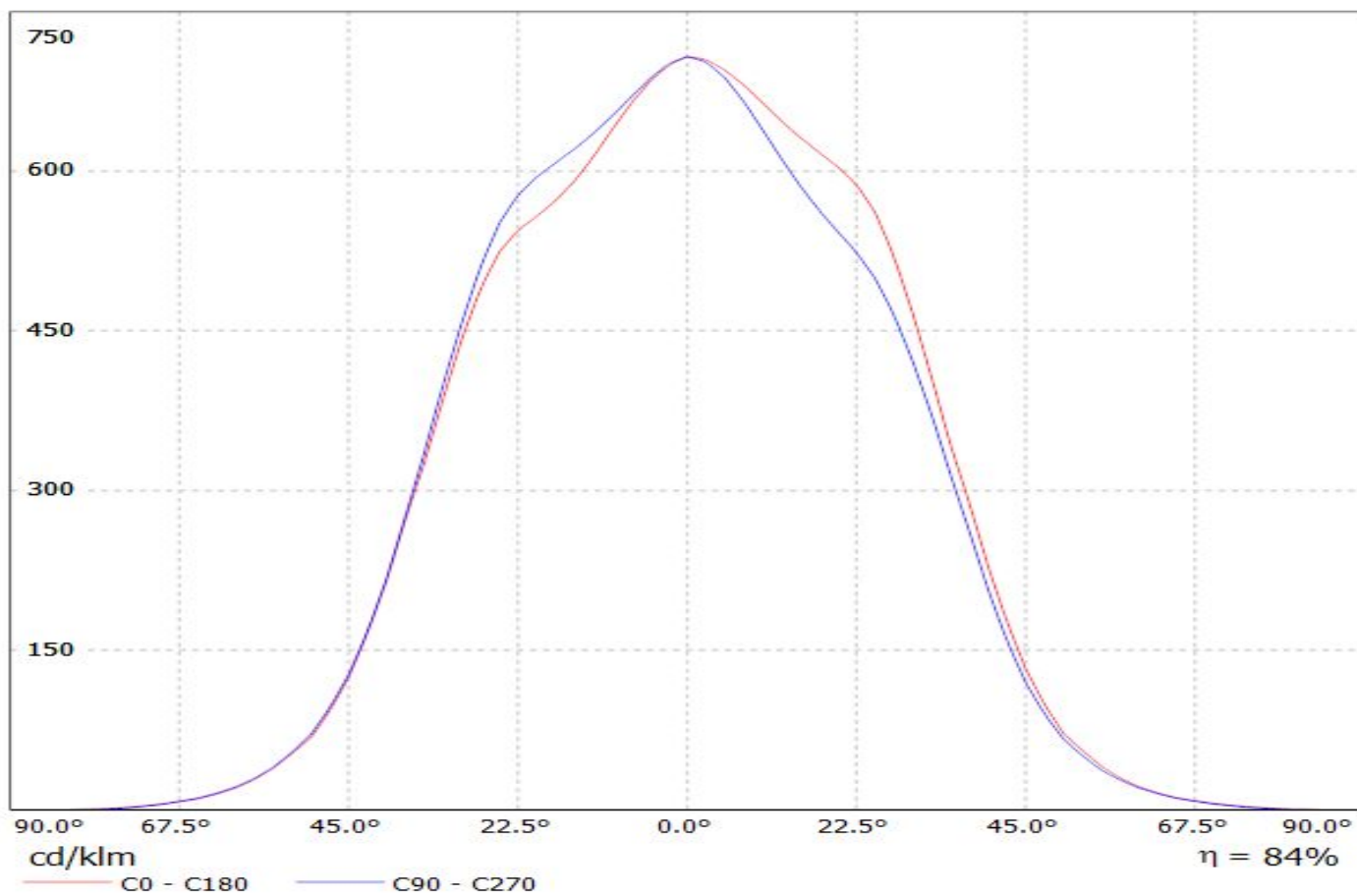

Luminaire: Ledil Oy CA12589_EMILY-WWW (Luxeon A 64lm @ 250mA) Efficiency=84%
Lamps: 1 x Luxeon A 64lm @ 250mA

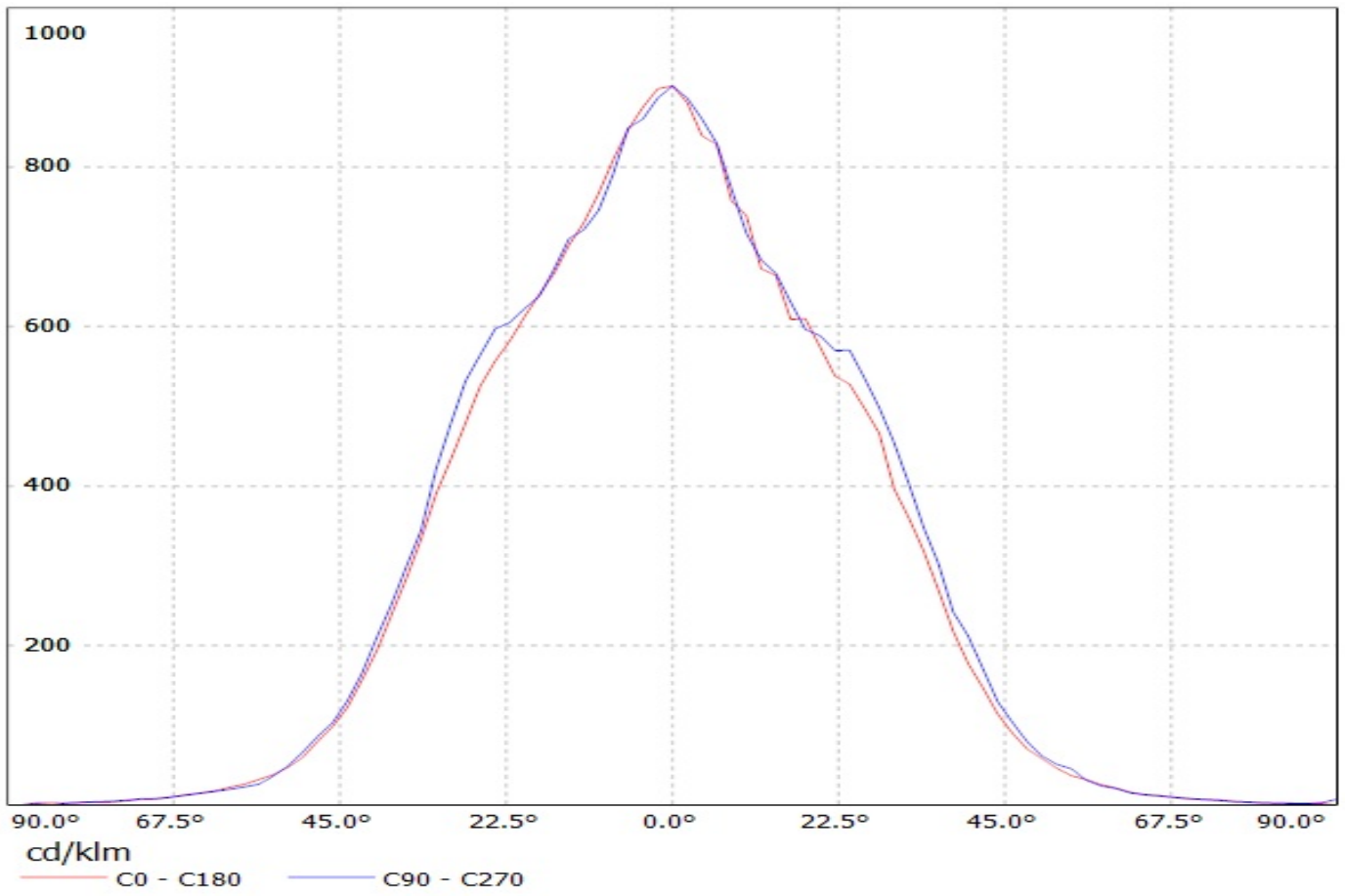

Luminaire: Ledil Oy CA12589_EMILY-WWW (Nichia 219B 103lm @ 250mA) Efficiency=85%
Lamps: 1 x Nichia 219B 103lm @ 250mA

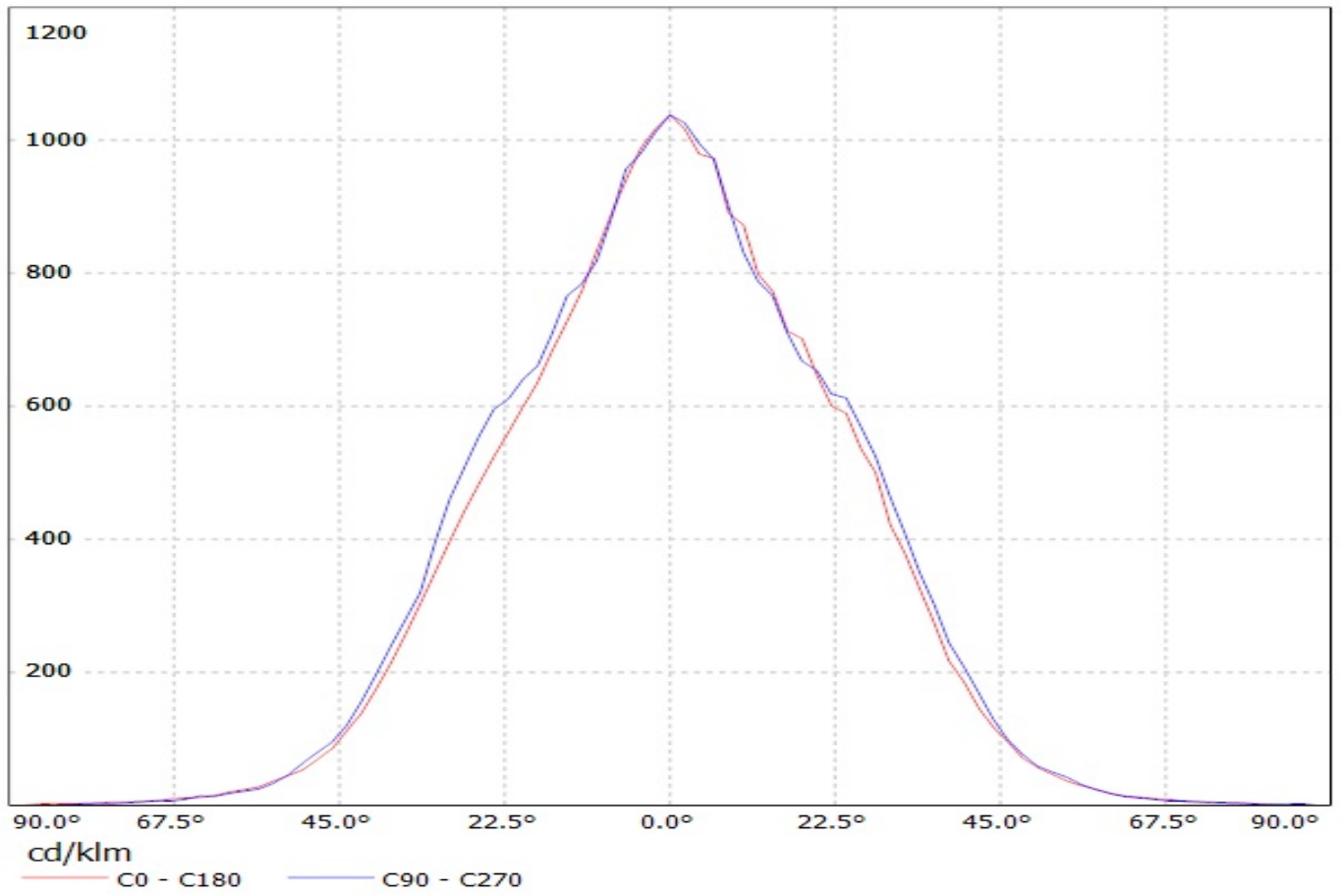

Luminaire: Ledil Oy CA12589_EMILY-WWW_(NCSxx19B) Efficiency=83%
Lamps: 1 x Nichia NCSxx19B (NCSL119BE) 88lm @ 250mA CCT=3000K P=0.8W I=250mA

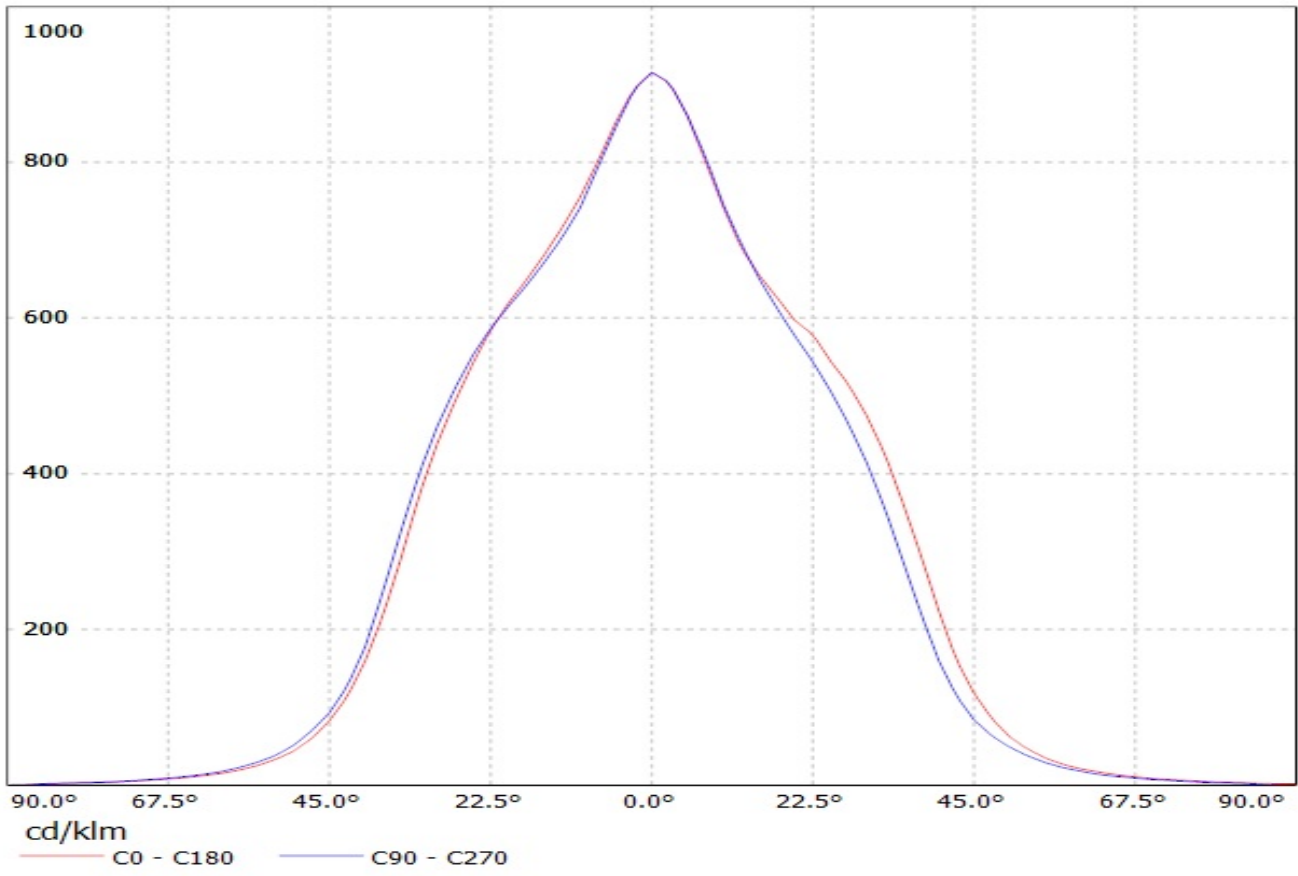

Luminaire: Ledil Oy CA12589_EMILY-WWW (Osram Square EC 66lm @ 250mA) Efficiency=85%
Lamps: 1 x Osram Square EC 66lm @ 250mA

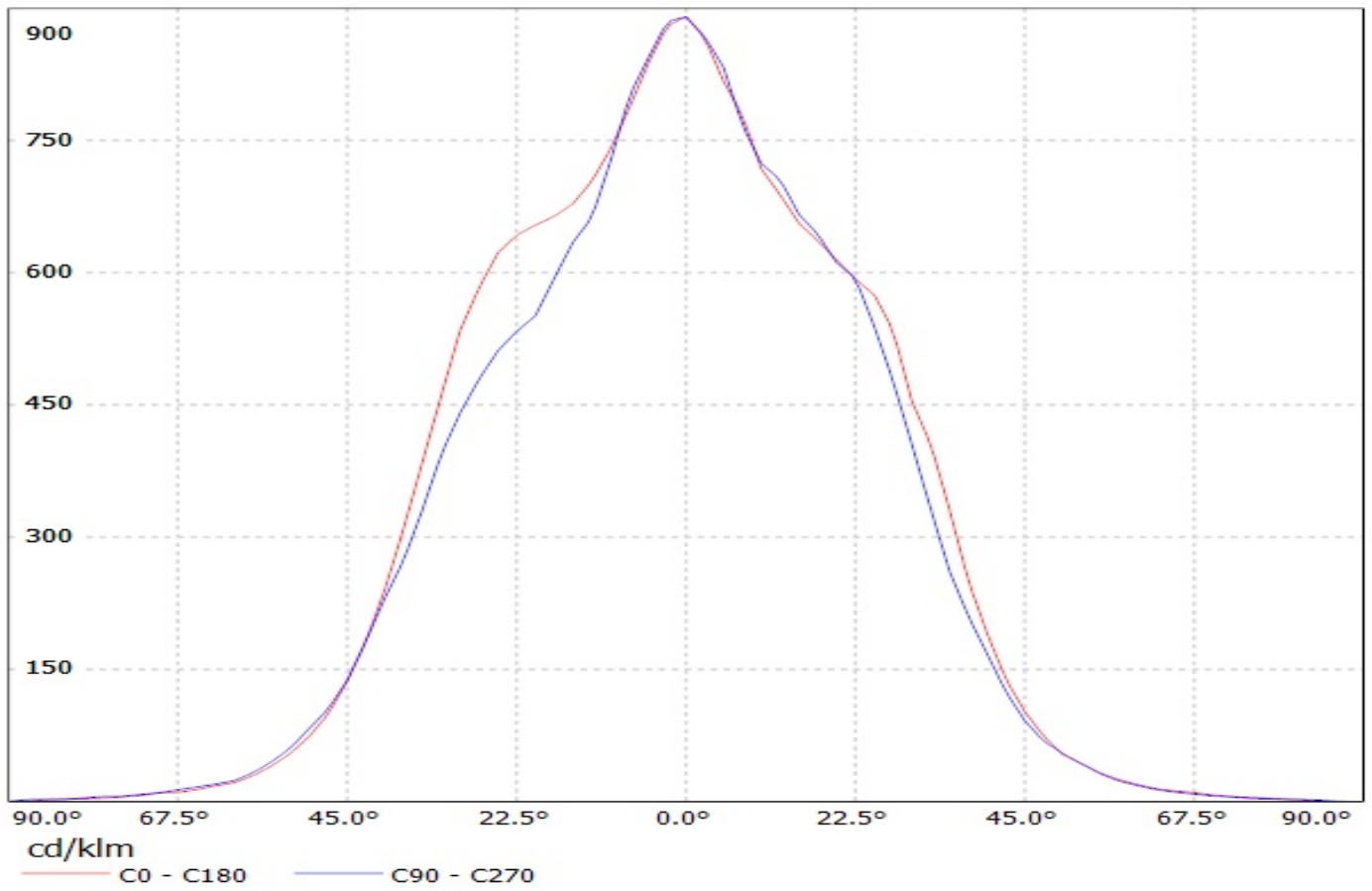

Luminaire: LEDiL Oy CA12589_EMILY-WWW_(Z8Y22plus)
Lamps: 1 x Seoul_Z8Y22plus_(W6E2G)_125.652lm@250mA_P=0.69312W_I=0.250A

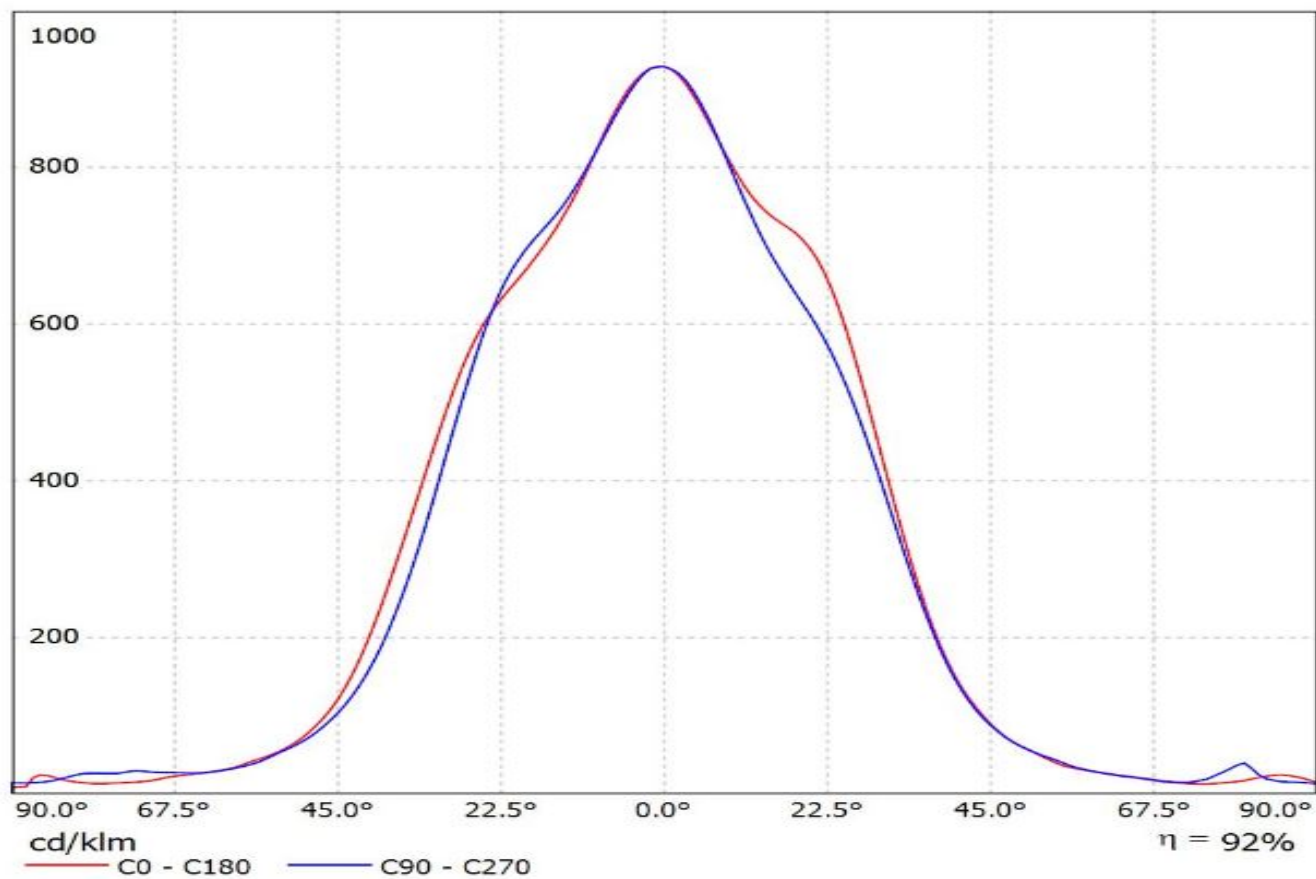

Luminaire: Ledil Oy CA12589_EMILY-WWW (Cree XP-E 66.5lm @ 250mA) Efficiency=86%
Lamps: 1 x Cree XP-E 66.5lm @ 250mA

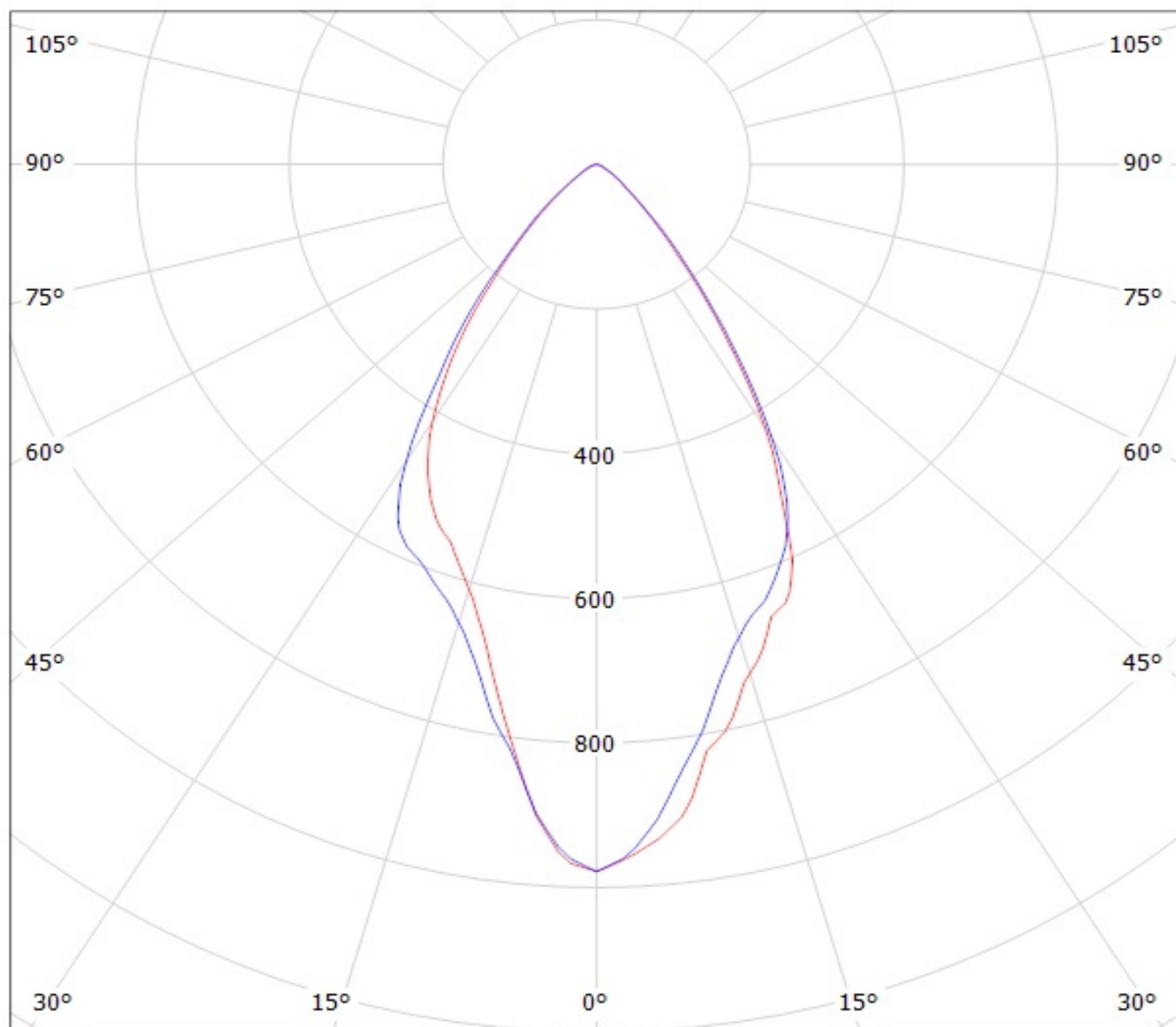

cd/klm

— C0 - C180

— C90 - C270

Luminaire: Ledil Oy CA12589_EMILY-WWW (Cree XP-G 58lm @ 250mA) Efficiency=86%
Lamps: 1 x Cree XP-G 58lm @ 250mA

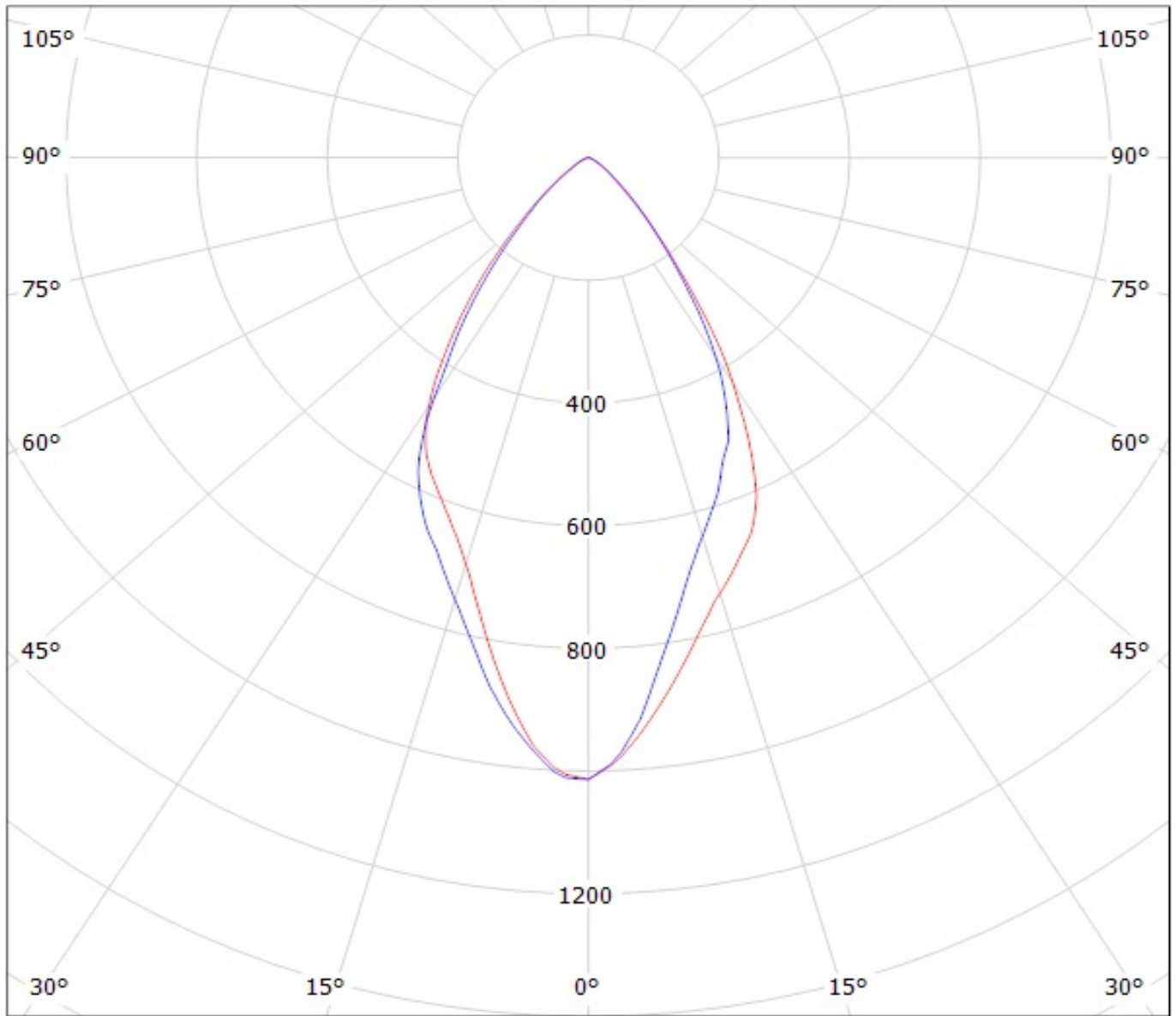

cd/klm

— C0 - C180 — C90 - C270

Luminaire: Ledil Oy CA12589_EMILY-WWW (Cree XP-G2 98.8lm @ 250mA) Efficiency=87%
Lamps: 1 x Cree XP-G2 98.8lm @ 250mA

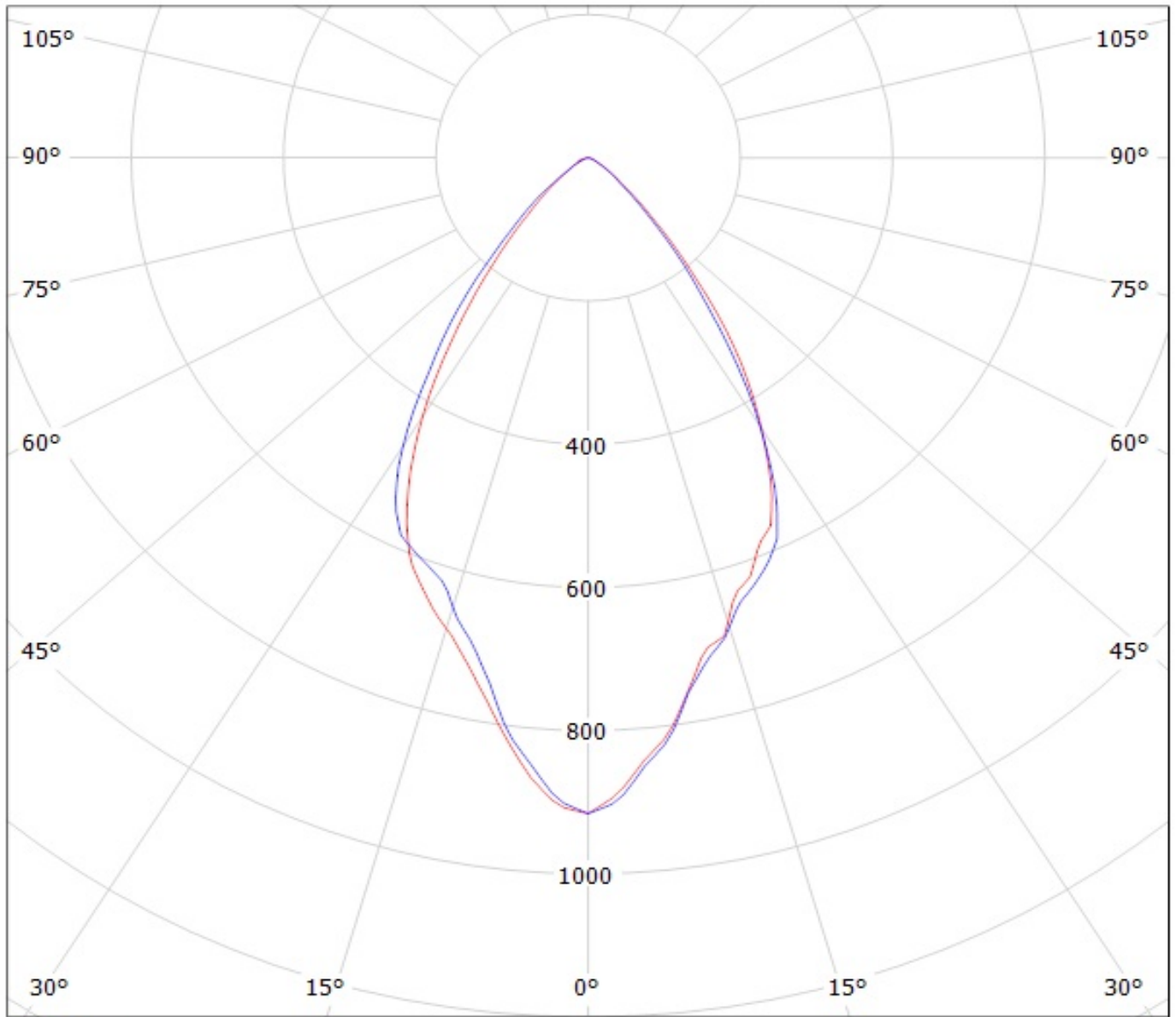

cd/klm

— C0 - C180

— C90 - C270

Luminaire: LEDil Oy CA12589_EMILY-WWW_(XP-E2)

Lamps: 1 x Cree XP-E2 (XPEBWT-L1-7B4-Q4-0-01) 78.62lm @ 250mA P=0.8W I=250mA

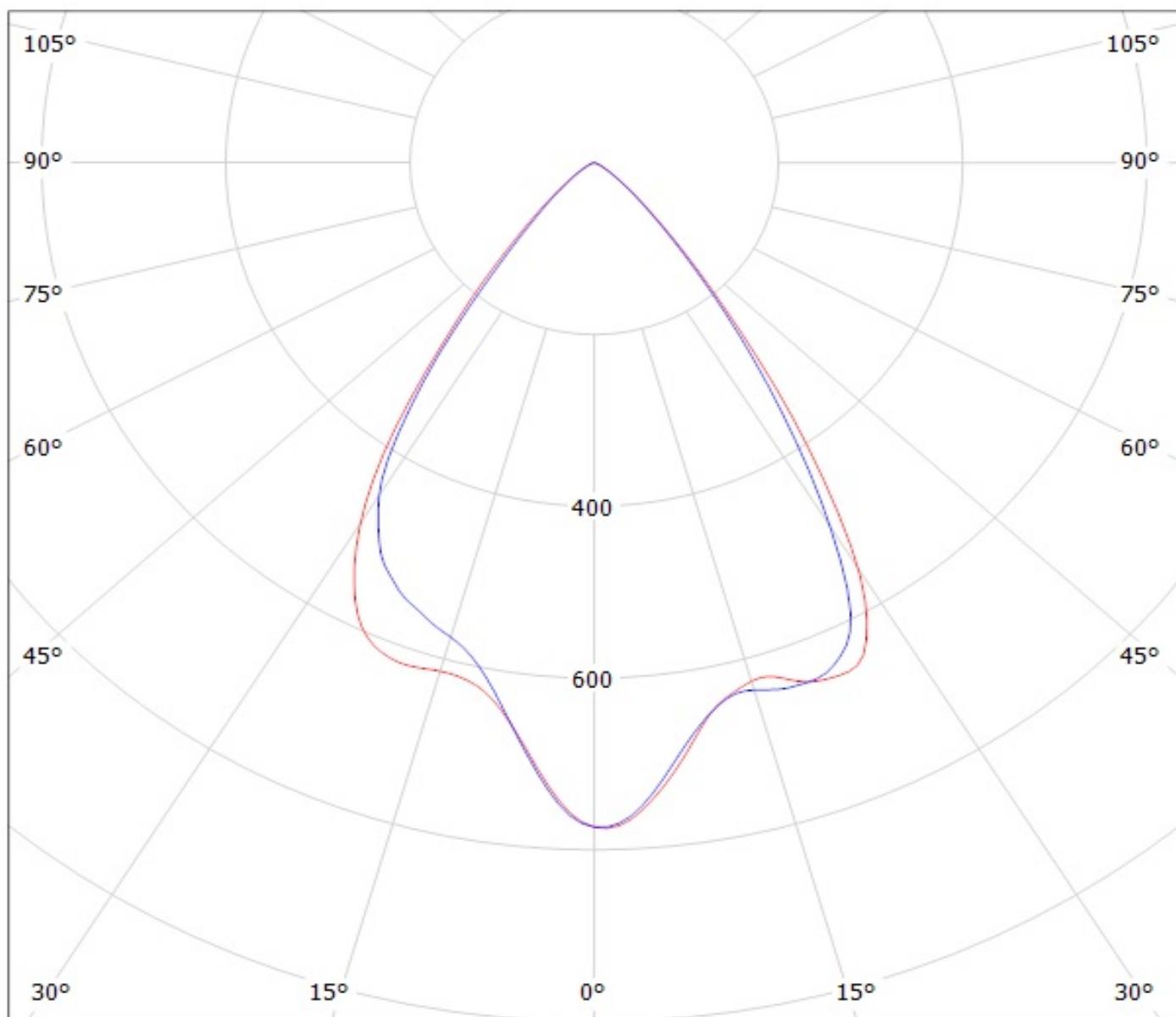

cd/klm

η = 86%

— C0 - C180

— C90 - C270

Luminaire: LEDiL Oy CA12589_EMILY-WWW_(XP-L) Eff.82.4%
Lamps: 1 x Cree_XP-L_127.813lm@250mA_P=0.73723W_I=249.9mA

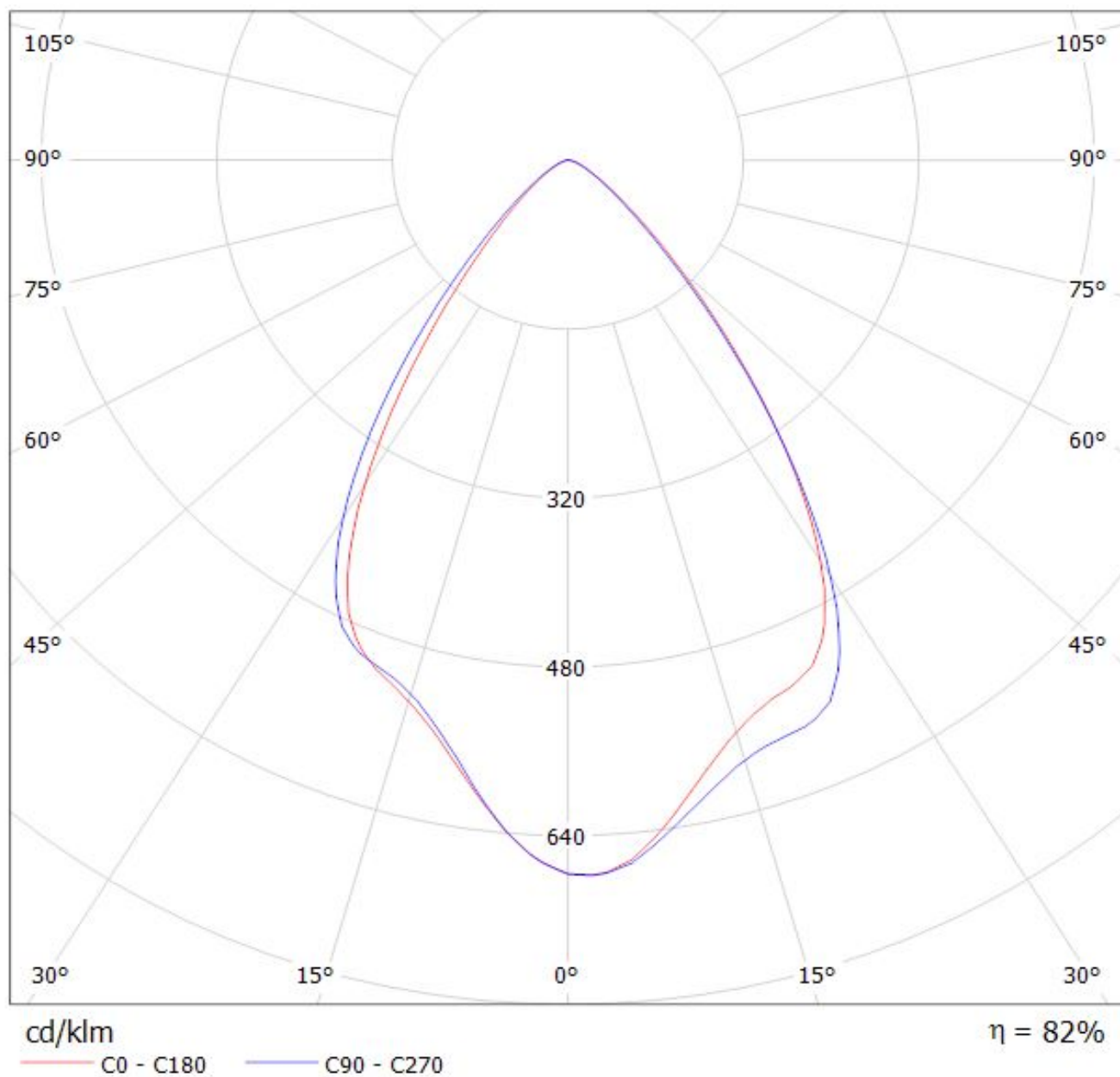

Luminaire: LEDiL Oy CA12589_EMILY-WWW_(XP-L_HI)

Lamps: 1 x Cree_XP-L_HI_114.406lm@250mA_P=0.745352W_I=0.2499A

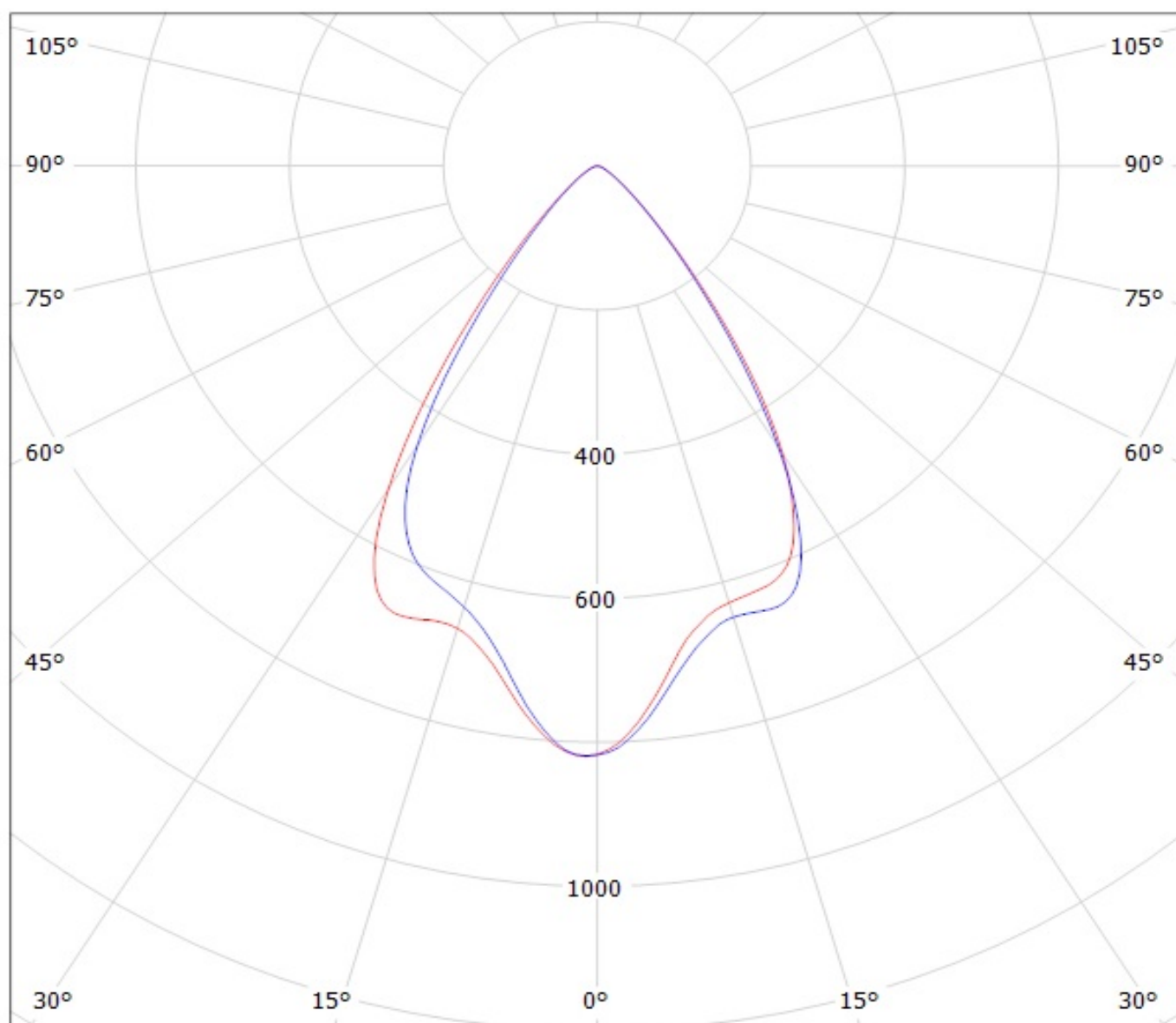

cd/klm

— C0 - C180 — C90 - C270

$\eta = 88\%$

Luminaire: LEDiL Oy
Lamps: 1 x CA12589_EMILY-WWW_(XHP35)

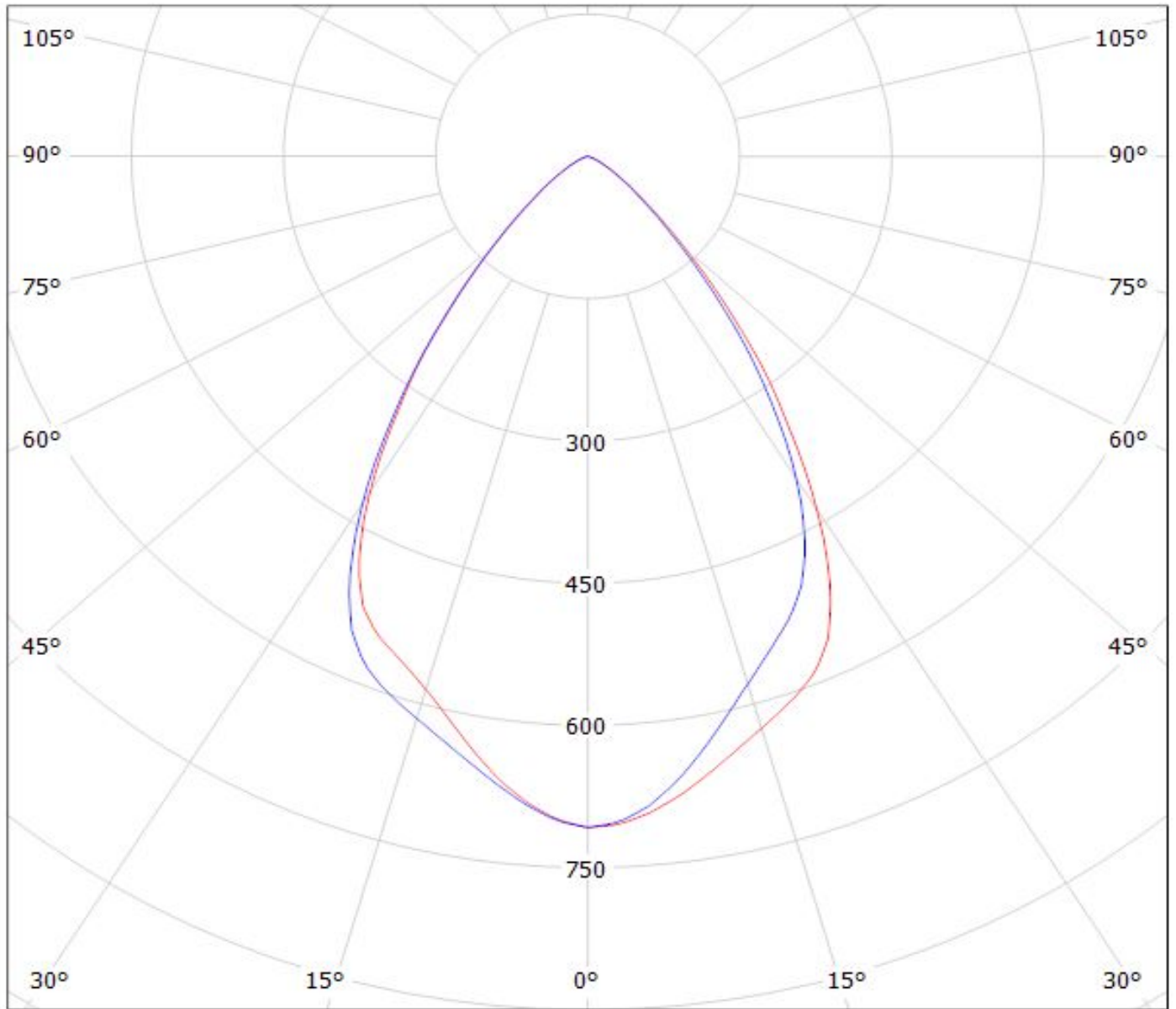

cd/klm

— C0 - C180 — C90 - C270

$\eta = 84\%$

Luminaire: Ledil Oy CA12589_EMILY-WWW (Luxeon A 64lm @ 250mA) Efficiency=84%
Lamps: 1 x Luxeon A 64lm @ 250mA

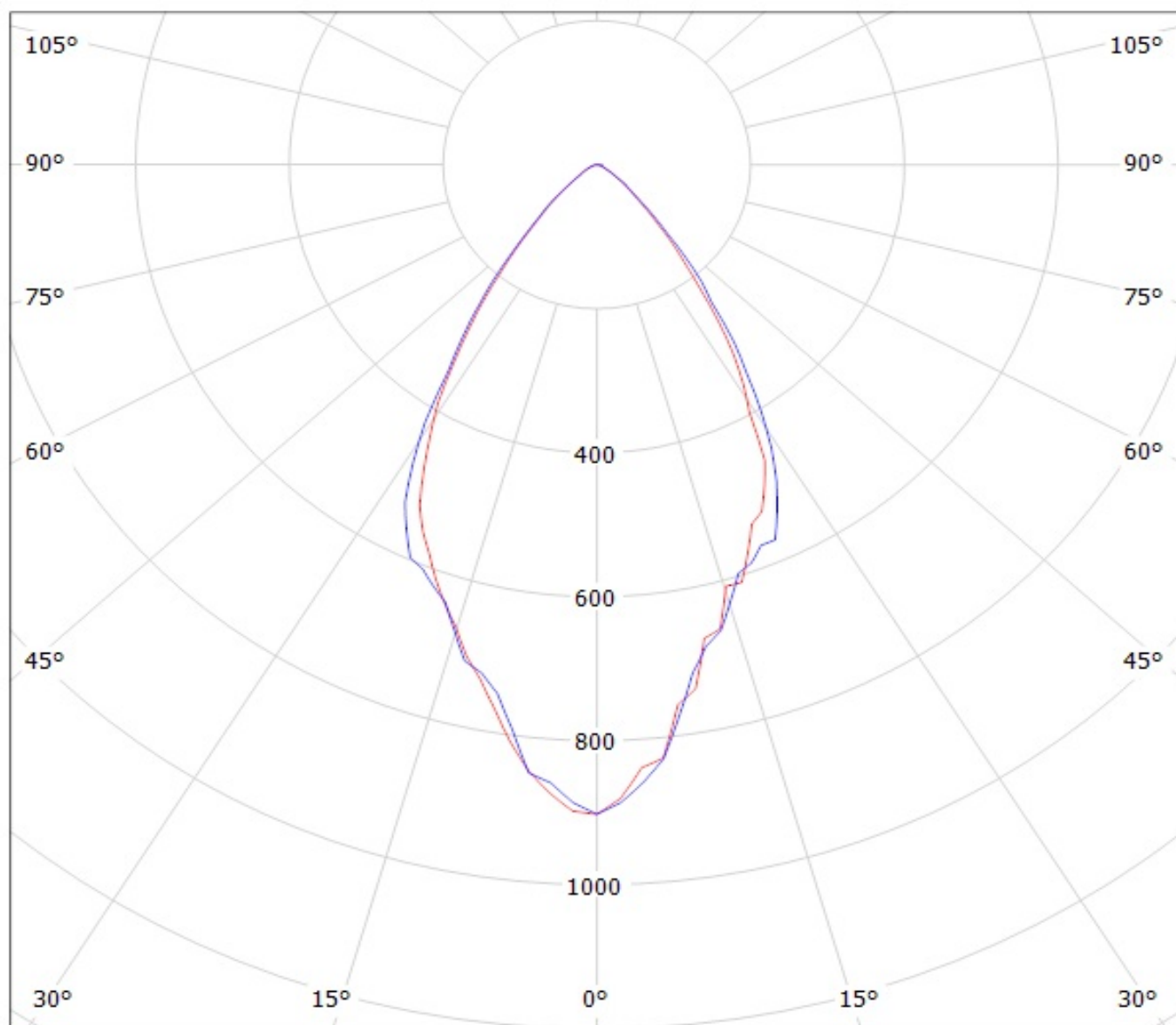

cd/klm

— C0 - C180

— C90 - C270

Luminaire: Ledil Oy CA12589_EMILY-WWW (Nichia 219B 103lm @ 250mA) Efficiency=85%
Lamps: 1 x Nichia 219B 103lm @ 250mA

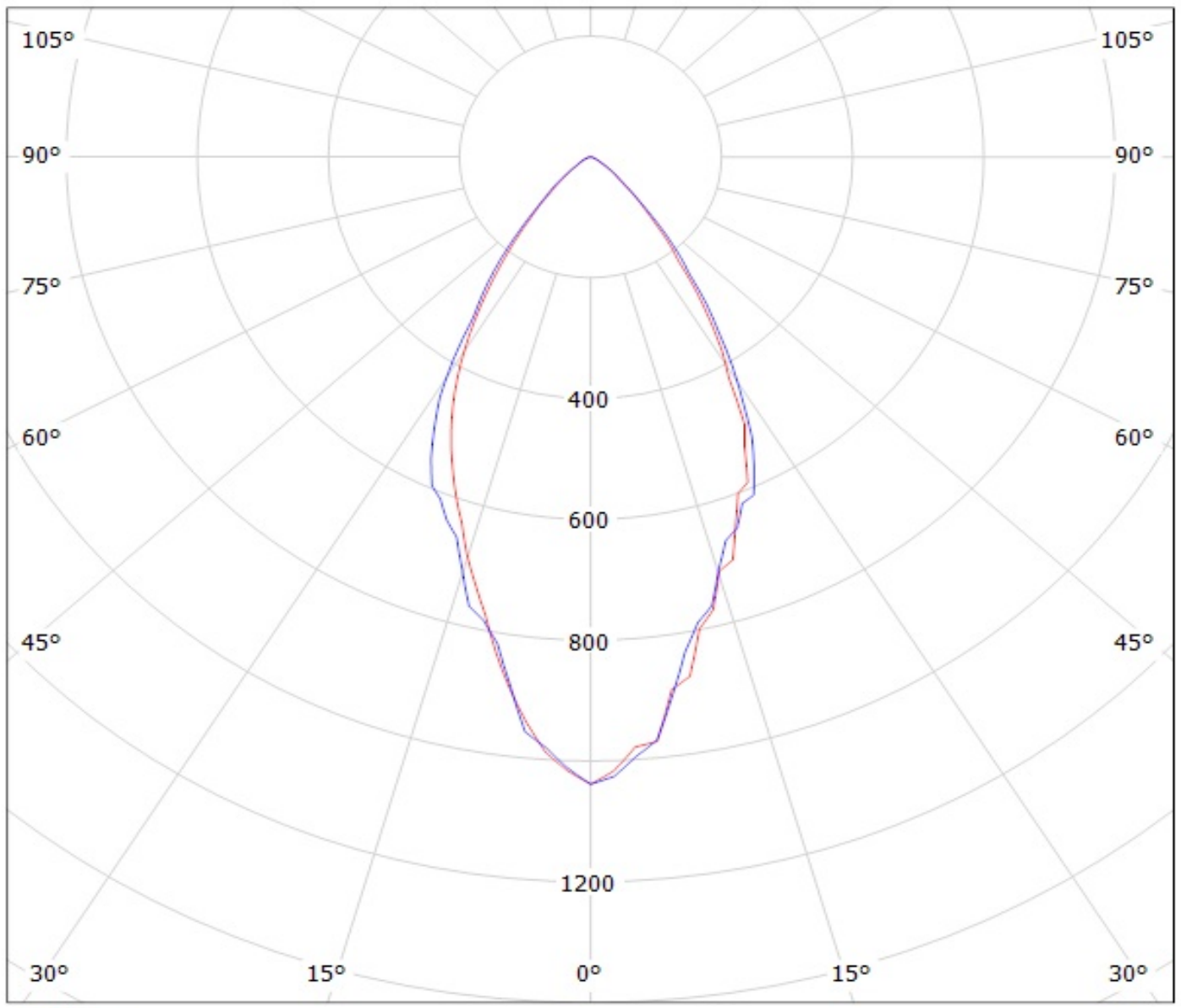

cd/klm

— C0 - C180 — C90 - C270

Luminaire: Ledil Oy CA12589_EMILY-WWW_(NCSxx19B) Efficiency=83%
Lamps: 1 x Nichia NCSxx19B (NCSL119BE) 88lm @ 250mA CCT=3000K P=0.8W I=250mA

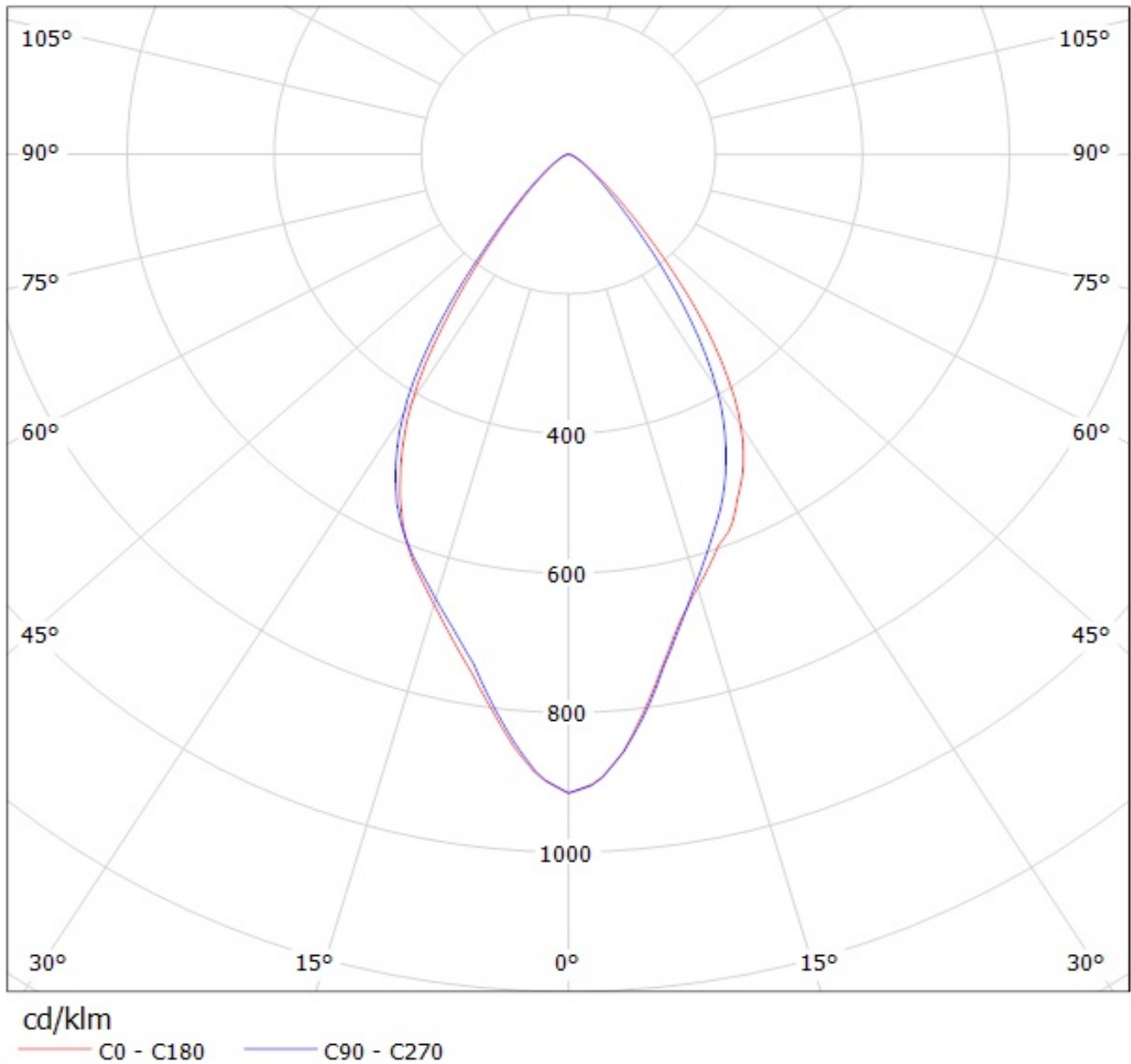

Luminaire: Ledil Oy CA12589_EMILY-WWW (Osram Square EC 66lm @ 250mA) Efficiency=85%
Lamps: 1 x Osram Square EC 66lm @ 250mA

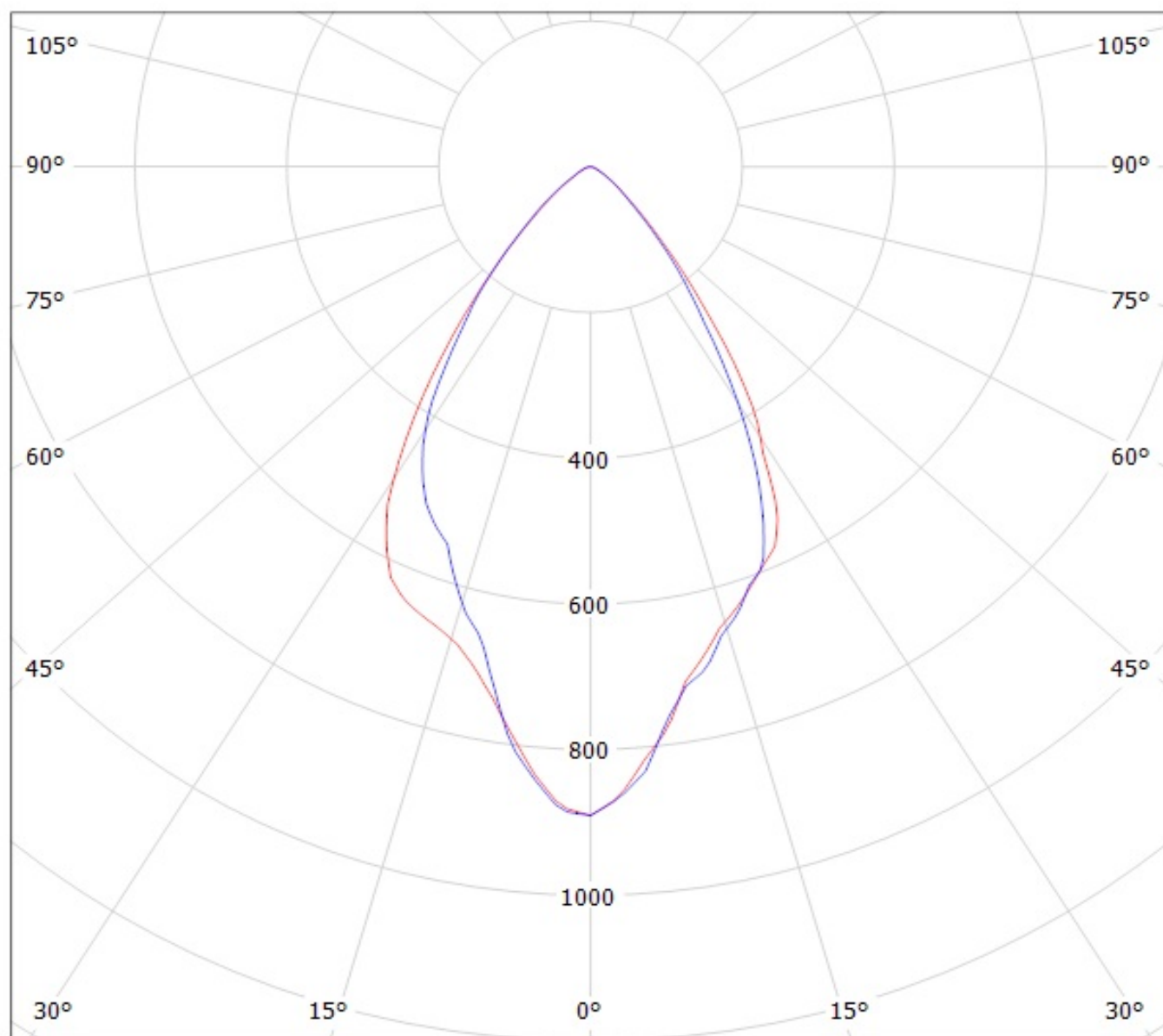

cd/klm

— C0 - C180

— C90 - C270

Luminaire: LEDiL Oy CA12589_EMILY-WWW_(Z8Y22plus)

Lamps: 1 x Seoul_Z8Y22plus_(W6E2G)_125.652lm@250mA_P=0.69312W_I=0.250A

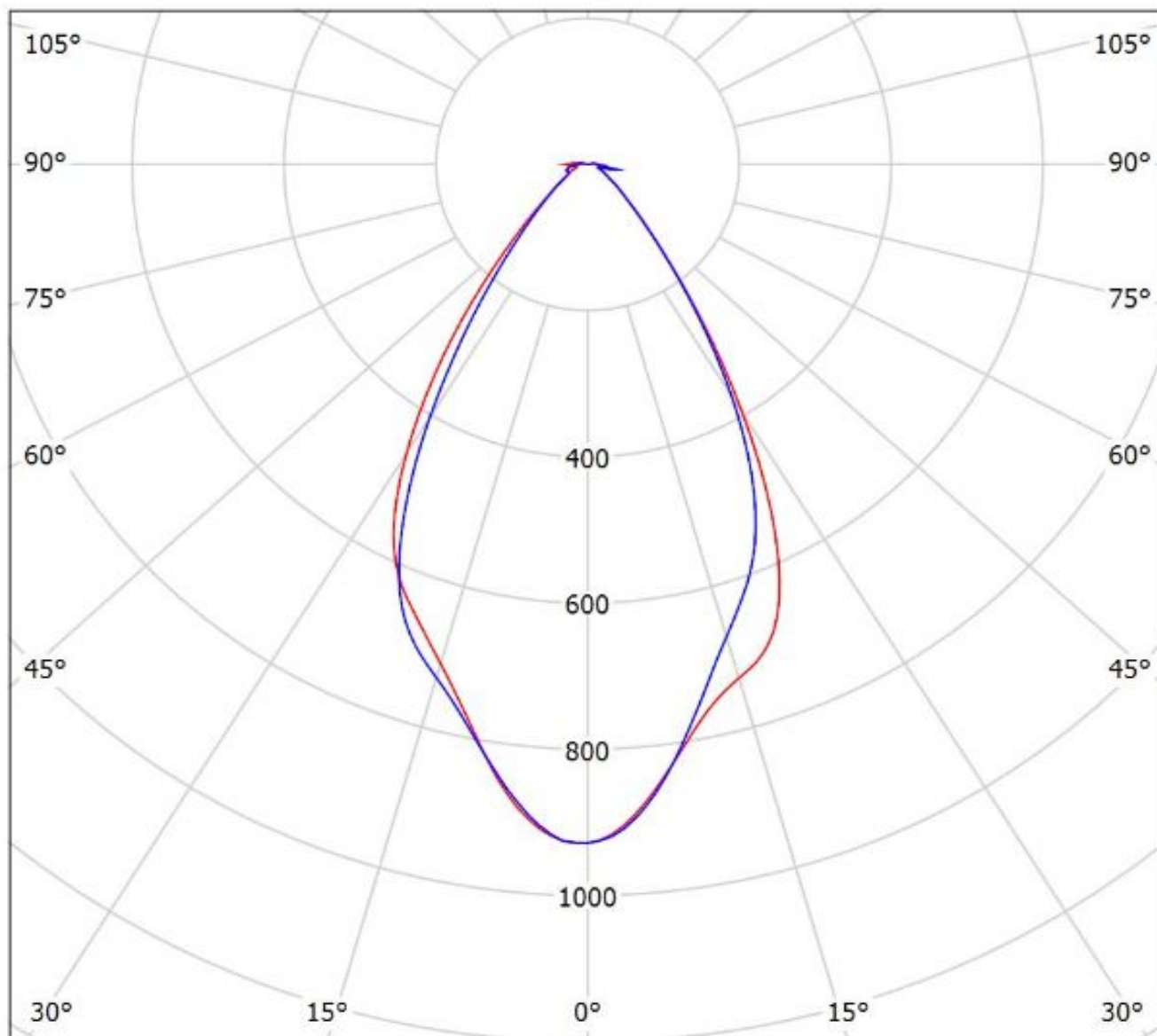

cd/klm

— C0 - C180 — C90 - C270

$\eta = 92\%$

NOTE: The typical divergence will be changed by different color, chip size and chip position tolerance. The typical total divergence is the full angle measured where the luminous intensity is half of the peak value.