

STRADA-SQ-VSM

IESNA Type V (square) beam for wide areas lighting such as car parks. Version with location pins. Assembly with installation tape.

TECHNICAL SPECIFICATIONS:

Dimensions	25.0 mm
Height	7 mm
Fastening	tape, pin, screw
Colour	clear
Box size	
Box weight	7.8 kg
Quantity in Box	pcs
ROHS compliant	yes ⓘ



MATERIAL SPECIFICATIONS:

Component	Type	Material	Colour
STRADA-SQ-VSM	Single lens	PMMA	clear
ROSE-TAPE	Tape	PU tape	black

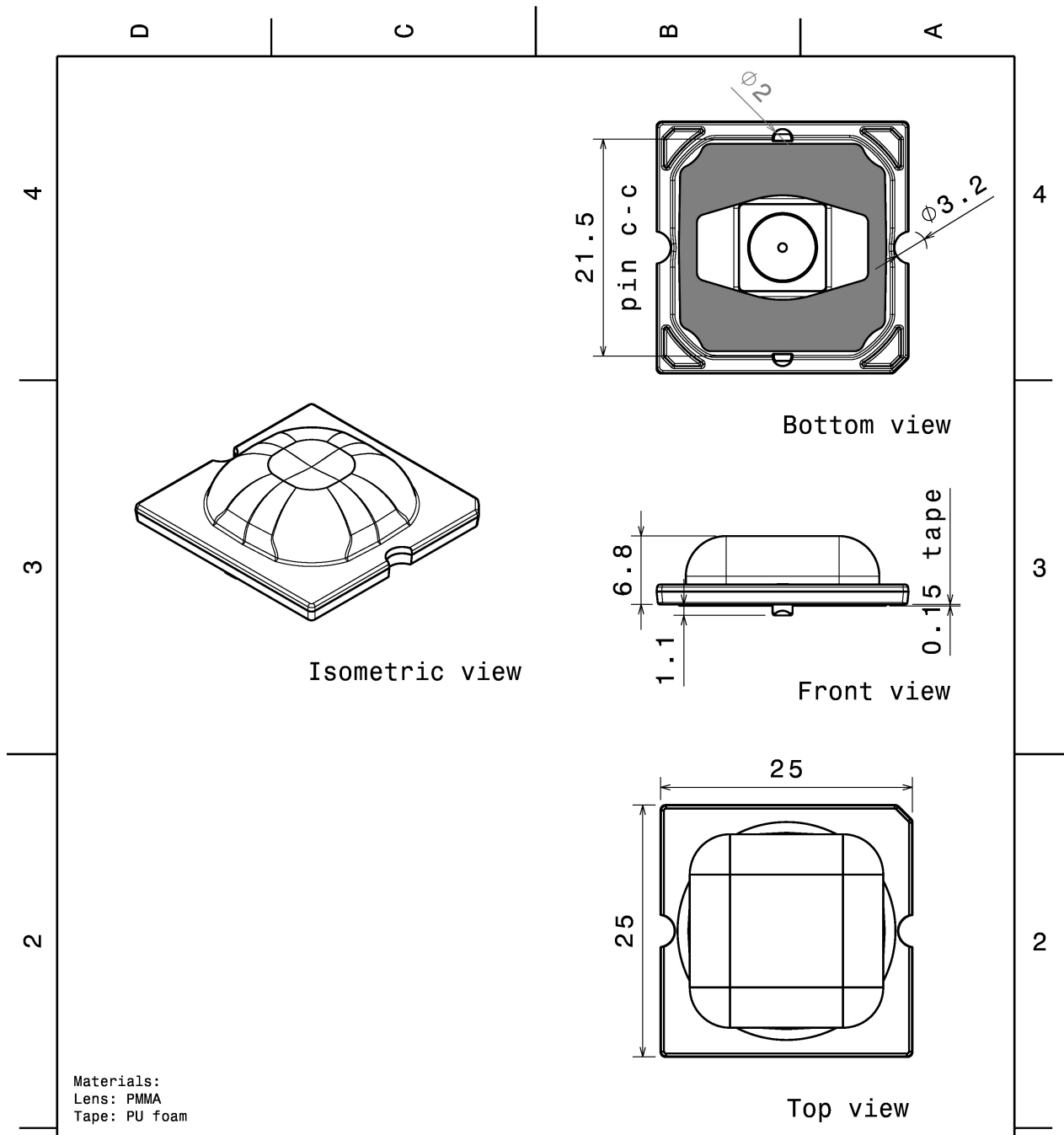

This drawing is our property. It can't be reproduced or communicated without our written agreement.		 Ledil Oy Salorankatu 10 FIN 24240 SALO Finland	
DRAWING TITLE		Datasheet STRADA-SQ-VSM	
DRAWN BY	DATE	SIZE	DRAWING NUMBER
ol	4.5.2012	A4	CA12891
CHECKED BY	DATE	SCALE	REV
PV	4.5.2012	2:1	01
DESIGNED BY	DATE	WEIGHT (kg)	SHEET
OL	24.4.2012	0,00	1/1

PHOTOMETRIC DATA (MEASURED):

CREE

LED MK-R
 FWHM 156.0°
 Efficiency 91 %
 Peak intensity 0.300 cd/lm
 LEDs/each optic 1
 Light colour White
 Required components:

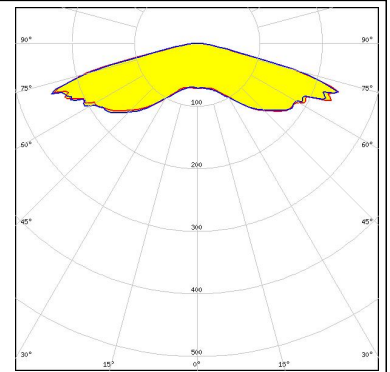

CREE

LED XHP35 HI
 FWHM 145.0°
 Efficiency 94 %
 Peak intensity 0.610 cd/lm
 LEDs/each optic 1
 Light colour White
 Required components:

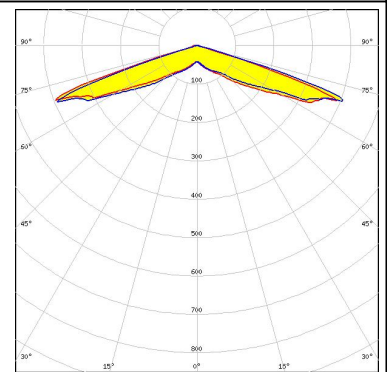

CREE

LED XM-L
 FWHM 154.0°
 Efficiency 93 %
 Peak intensity 0.200 cd/lm
 LEDs/each optic 1
 Light colour White
 Required components:

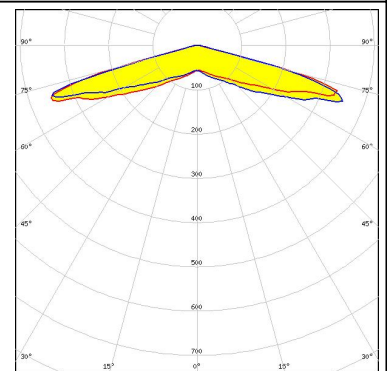

CREE

LED XM-L2
 FWHM 155.0°
 Efficiency 94 %
 Peak intensity 0.400 cd/lm
 LEDs/each optic 1
 Light colour White
 Required components:

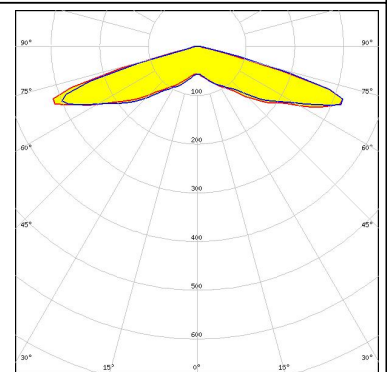

PHOTOMETRIC DATA (MEASURED):



LED XP-L HD
 FWHM 150.0°
 Efficiency 94 %
 Peak intensity 0.500 cd/lm
 LEDs/each optic 1
 Light colour White
 Required components:

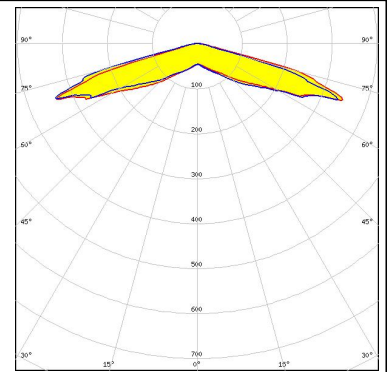
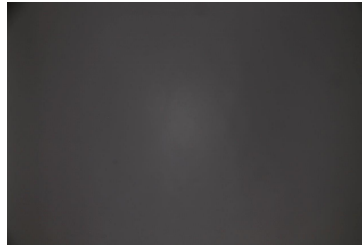

LED XP-L2
 FWHM 146.0°
 Efficiency 93 %
 Peak intensity 0.400 cd/lm
 LEDs/each optic 1
 Light colour White
 Required components:

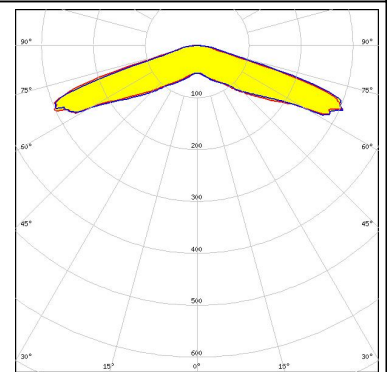

LED XT-E
 FWHM 151.0°
 Efficiency 93 %
 Peak intensity 0.200 cd/lm
 LEDs/each optic 1
 Light colour White
 Required components:

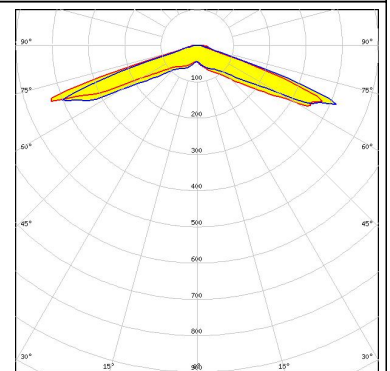

LED LUXEON M/MX
 FWHM 154.0°
 Efficiency 93 %
 Peak intensity 0.250 cd/lm
 LEDs/each optic 1
 Light colour White
 Required components:

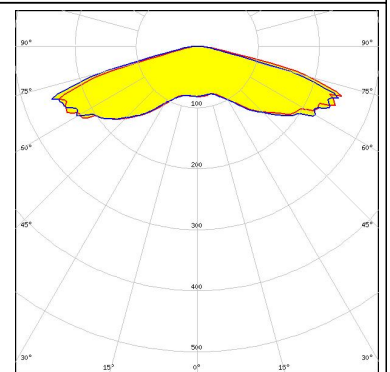

PHOTOMETRIC DATA (MEASURED):

LUMILEDS

LED LUXEON MZ
FWHM 148.0°
Efficiency 94 %
Peak intensity 0.410 cd/lm
LEDs/each optic 1
Light colour White
Required components:

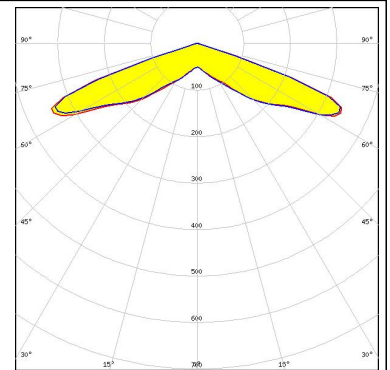

LUMILEDS

LED LUXEON T
FWHM 145.0°
Efficiency 92 %
Peak intensity 0.700 cd/lm
LEDs/each optic 1
Light colour White
Required components:

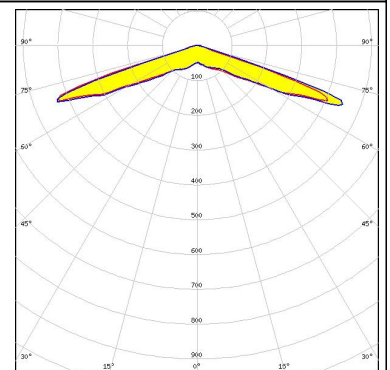

LUMILEDS

LED LUXEON TX
FWHM 148.0°
Efficiency 94 %
Peak intensity 0.670 cd/lm
LEDs/each optic 1
Light colour White
Required components:

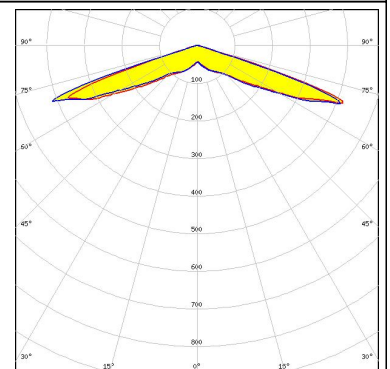

LUMILEDS

LED LUXEON XR-M linear 1x3, 1x4, 1x5
FWHM 151.0°
Efficiency 92 %
Peak intensity 0.340 cd/lm
LEDs/each optic 1
Light colour White
Required components:

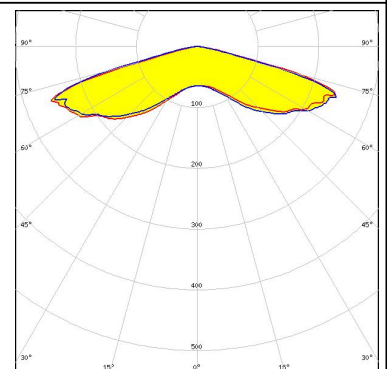

PHOTOMETRIC DATA (MEASURED):



LED NCSU033A
 FWHM 149.0°
 Efficiency 93 %
 Peak intensity 0.590 cd/lm
 LEDs/each optic 1
 Light colour White
 Required components:

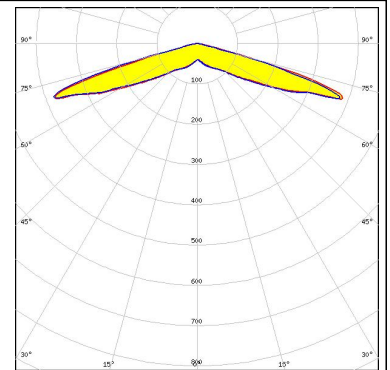

LED NS9x383
 FWHM 149.0°
 Efficiency 91 %
 Peak intensity 0.470 cd/lm
 LEDs/each optic 1
 Light colour White
 Required components:

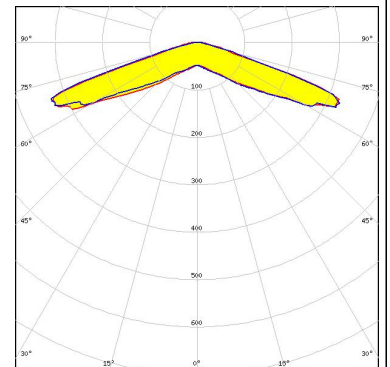

LED NV4x144A
 FWHM 156.0°
 Efficiency 91 %
 Peak intensity 0.330 cd/lm
 LEDs/each optic 1
 Light colour White
 Required components:

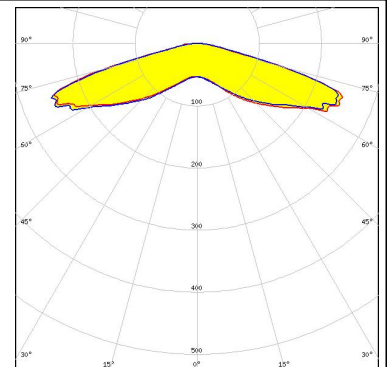

LED Duris S10
 FWHM 148.0°
 Efficiency 93 %
 Peak intensity 0.330 cd/lm
 LEDs/each optic 1
 Light colour White
 Required components:

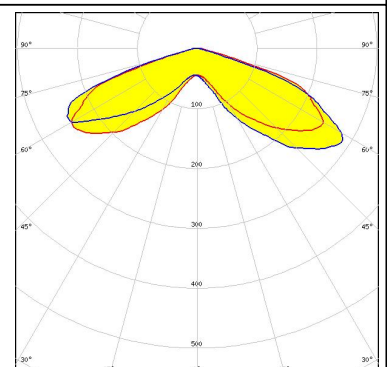

PHOTOMETRIC DATA (SIMULATED):

LUMILEDS

LED LUXEON H50-2
FWHM 140.0°
Efficiency 90 %
Peak intensity 0.550 cd/lm
LEDs/each optic 1
Light colour White
Required components:

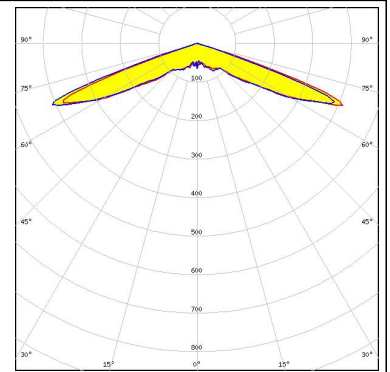

NICHIA

LED NVSxx19B/NVSxx19C
FWHM 144.0°
Efficiency 89 %
Peak intensity 0.500 cd/lm
LEDs/each optic 1
Light colour White
Required components:

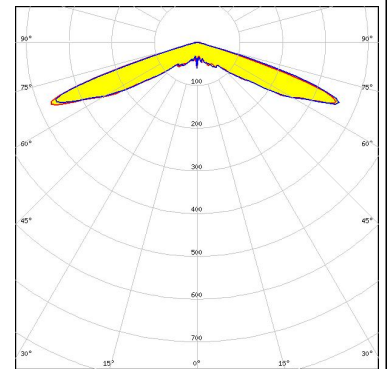

OSRAM

Opto Semiconductors

LED OSCONIQ P 7070
FWHM 150.0°
Efficiency 89 %
Peak intensity 0.400 cd/lm
LEDs/each optic 1
Light colour White
Required components:

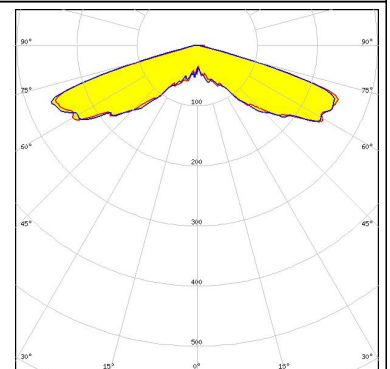

SAMSUNG

LED LH351B
FWHM 148.0°
Efficiency 91 %
Peak intensity 0.430 cd/lm
LEDs/each optic 1
Light colour White
Required components:

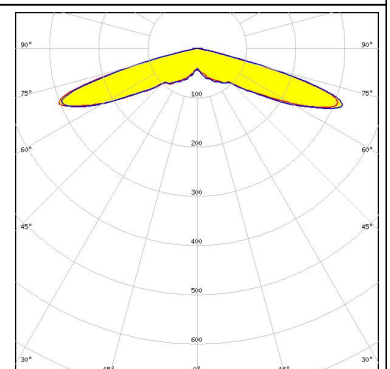

GENERAL INFORMATION:

NOTE: The typical beam angle will be changed by different color, chip size and chip position tolerance. The typical total beam angle is the full angle measured where the luminous intensity is half of the peak value.

MATERIALS:

As part of our continuous research and improvement processes, and to ensure the best possible quality and availability of our products, LEDiL reserves the right to change material grades without notice.

PRODUCT DATA USER AGREEMENT AND DISCLAIMER:

The measured data in the provided downloadable LEDiL Product Datasheets and Mechanical 2D-Drawings is rounded and provided as reference for planning. LEDiL Oy's optical specifications have been verified by conducting performance testing of the products in accordance with the company's quality system. The reported data are averaged results of multiple measurements with typical variation. LEDiL Oy reserves the right to without prior notification make changes and improvements to its products.

LEDiL Oy assumes neither warranty, nor guarantee nor any other liability of any kind for the contents and correctness of the provided data. The provided data has been generated with highest diligence but the provided data may in reality not represent the complete possible variation range of all intrinsic parameters. Therefore, in certain cases a deviation from the provided data could occur.

LEDiL Oy reserves the right to undertake technical changes of its products without further notification which could lead to changes in the provided data. LEDiL Oy assumes no liability of any kind for the possible deviation from any provided data or any other damage resulting from the usage of the provided data.

The user agrees to this disclaimer and user agreement with the download or usage of the provided files.

LEDiL Oy

Joensuunkatu 13
FI-24240 SALO
Finland

LEDiL Inc.

228 West Page Street
Suite D
Sycamore IL 60178
USA

Local sales and technical support

[www.ledil.com/
where_to_buy](http://www.ledil.com/where_to_buy)

Shipping locations

Salo, Finland
Hong Kong, China

Distribution Partners

[www.ledil.com/
where_to_buy](http://www.ledil.com/where_to_buy)