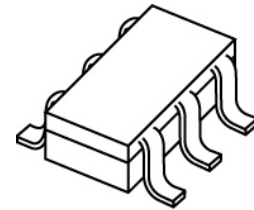

**Step-Down LED Driver**

## Features

- Maximum constant output current: 750mA
- 96% efficiency @ input voltage 12V, 350mA, 3-LED
- 6~30V input voltage range
- Hysteretic PFM improves efficiency at light loading
- Settable output current
- Integrated power switch with 0.45ohm low Rds(on)
- Full protection: Thermal/Start-Up/LED Open-/Short- Circuit
- Only 4 external components required
- Package MSL Level : 3

**Small Outline Transistor**

GST: SOT-23-6L

**Mini Small Outline Package**

GMS: MSOP-8L-118mil

## Product Description

The MBI6652 is a high efficiency, constant current and step-down DC/DC converter. It is designed to deliver constant current to light up high power LED with only 4 external components. With hysteretic PFM control scheme, MBI6652 improves the efficiency of light loading. The output current of MBI6652 can be programmed by an external resistor and LED dimming can be controlled via pulse width modulation (PWM) through DIM pin. In addition, the start-up function limits the inrush current while the power is switch on. The MBI6652 also features over temperature protection, LED open-circuit protection and LED short-circuit protection to protect IC from being damaged.

Additionally, to ensure the system reliability, the MBI6652 builds thermal protection (TP) function inside. This function protects IC from overheating (165°C) in various application conditions. MBI6652 provides thermal- enhanced packages as well to handle power dissipation more efficiently. MBI6652 is available in SOT-23-6L and MSOP-8L packages.

## Applications

- Signage and Decorative LED Lighting
- Automotive LED Lighting
- High Power LED Lighting
- Constant Current Source

Typical Application Circuit

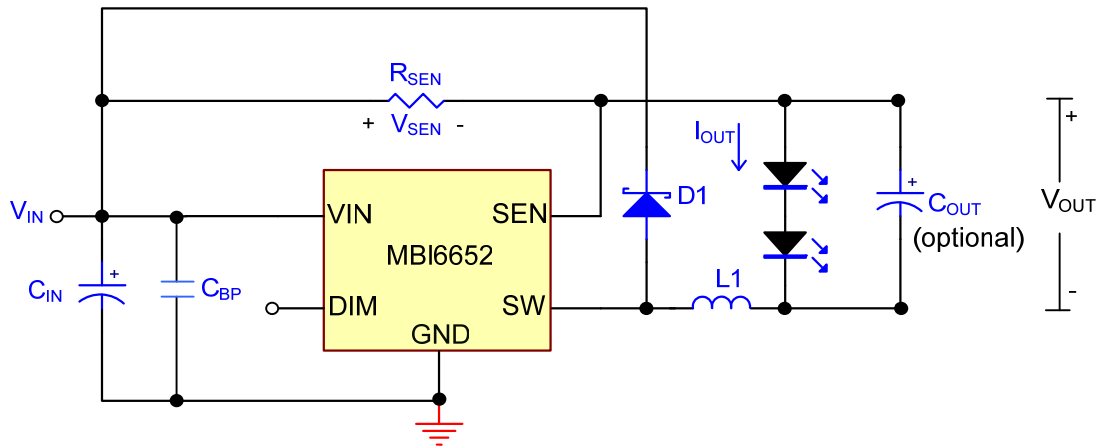

- C<sub>IN</sub>: VISHAY, 293D106X9050D2TE3, D case Tantalum Capacitor
- C<sub>OUT</sub>: VISHAY, 293D106X9050D2TE3, D case Tantalum Capacitor
- C<sub>BP</sub>: TAIYO YUDEN, UMK212B7104MG-T, 0805 Ceramic Capacitor
- L1: GANG SONG, GSDS106C2-680M
- D1: ZOWIE, SSCD206
- R<sub>SEN</sub>: VIKING, CSO6FTEUR100, 1206

Figure 1

Functional Diagram

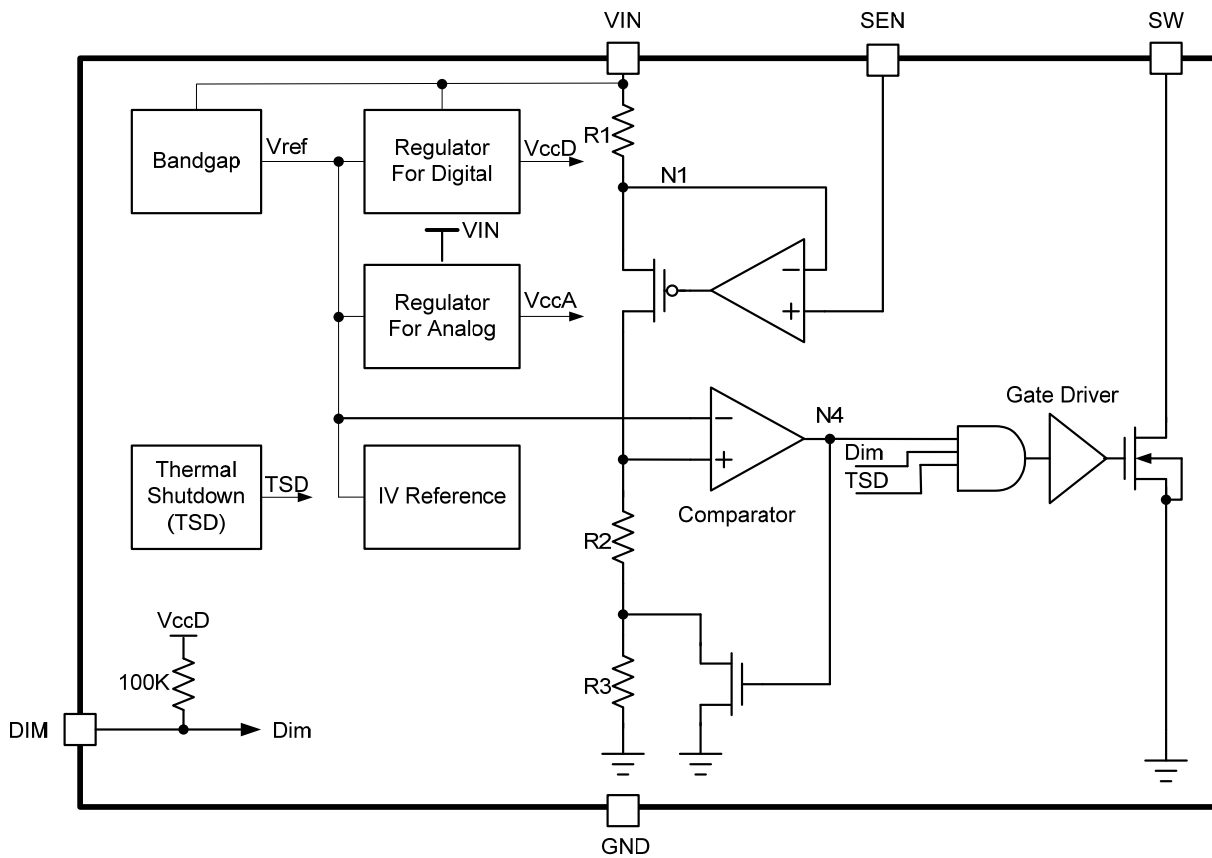
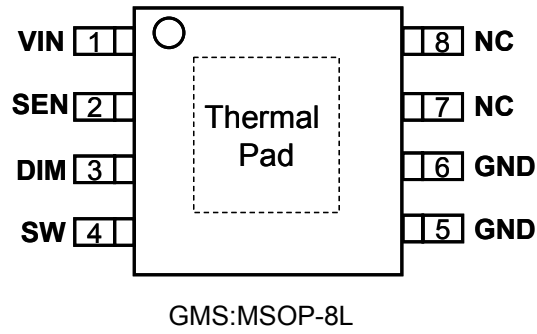
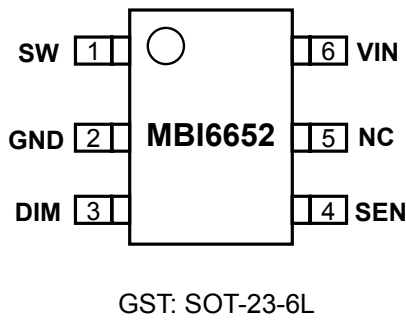

Figure 2

Pin Configuration



Pin Description

Pin Name	Function
GND	Ground terminal for control logic and current sink
SW	Switch output terminal
DIM	Dimming control terminal. If the dimming function is unnecessary, please let this pin open.
SEN	Output current sense terminal
VIN	Supply voltage terminal
NC	No connection
Thermal Pad	Power dissipation terminal connected to GND*

\*To eliminate noise influence, the thermal pad is suggested to connect to GND on PCB. In addition, when a heat-conducting copper foil on PCB is soldered with thermal pad, the desired thermal conductivity will be improved.

## Maximum Ratings

Operation above the maximum ratings may cause device failure. Operation at the extended periods of the maximum ratings may reduce the device reliability.

Characteristic		Symbol	Rating	Unit
Supply Voltage		$V_{IN}$	0~33	V
Output Current		$I_{OUT}$	1	A
Sustaining Voltage at DIM pin		$V_{DIM}$	32	V
Sustaining Voltage at SW pin		$V_{SW}$	-0.5~33	V
GND Terminal Current		$I_{GND}$	1	A
Power Dissipation (On 4 Layer PCB, $T_a=25^{\circ}C$ )	GST Type	$P_D$	0.51	W
Thermal Resistance (By simulation, on 4 Layer PCB)*		$R_{th(j-a)}$	244	$^{\circ}C/W$
Power Dissipation (On 4 Layer PCB, $T_a=25^{\circ}C$ )	GMS Type	$P_D$	3.33	W
Thermal Resistance (By simulation, on 4 Layer PCB)*		$R_{th(j-a)}$	37.53	$^{\circ}C/W$
Junction Temperature		$T_{j,max}$	150**	$^{\circ}C$
Operating Ambient Temperature		$T_{opr}$	-40~+85	$^{\circ}C$
Storage Temperature		$T_{stg}$	-55~+150	$^{\circ}C$
ESD Rating	Human Body Mode (MIL-STD-883E Method 3015.7)	HBM	Class 3 ( $\geq 4000V$ )	-
	Machine Mode (ESDA STM5.2)	MM	Class 3 ( $\geq 400V$ )	-

\*The PCB size is 76.2mm\*114.3mm in simulation. Please refer to JEDEC JESD51.

\*\* Operation at the maximum rating for extended periods may reduce the device reliability; therefore, the suggested junction temperature of the device is under 125 $^{\circ}C$ .

Note: The performance of thermal dissipation is strongly related to the size of thermal pad, thickness and layer numbers of the PCB. The empirical thermal resistance may be different from simulative value. Users should plan for expected thermal dissipation performance by selecting package and arranging layout of the PCB to maximize the capability.

**Electrical Characteristics**

Test condition:  $V_{IN}=12V$ ,  $V_{OUT}=3.6V$ ,  $L1=68\mu H$ ,  $C_{IN}=C_{OUT}=10\mu F$ ,  $T_A=25^{\circ}C$ ; unless otherwise specified. Please refer to test circuit (a) of Figure 3.)

Characteristics	Symbol	Condition	Min.	Typ.	Max.	Unit	
Supply Voltage	$V_{IN}$	-	6	-	30	V	
Supply Current	$I_{IN}$	$V_{IN}=6V\sim 30V$	-	1	2	mA	
Output Current	$I_{OUT}$	-	-	350	750	mA	
Output Current Accuracy	$dI_{OUT}/I_{OUT}$	$350mA \leq I_{OUT} \leq 750mA$ ,	-	$\pm 3$	$\pm 5$	%	
SW Dropout Voltage	$\Delta V_{SW}$	$I_{OUT}=700mA$	-	0.315	-	V	
Internal Propagation Delay Time	$T_{pd}$	-	100	196	300	ns	
Efficiency	-	$V_{IN}=12V$ , $I_{OUT}=350mA$ , $V_{OUT}=10.8V$	-	96	-	%	
Input voltage of DIM	“H” level	$V_{IH}$	-	3.5	-	5	V
	“L” level	$V_{IL}$	-	0	-	0.5	V
Switch ON Resistance	$R_{ds(on)}$	$V_{IN}=12V$ ; refer to test circuit (b)	0.4	0.45	0.6	$\Omega$	
Minimum Switch ON Time*	$T_{ON,MIN}$	-	100	350	450	ns	
Minimum Switch OFF Time*	$T_{OFF,MIN}$	-	100	350	450	ns	
Recommended Duty Cycle Range of SW*	$D_{sw}$	-	20	-	80	%	
Operating frequency	$Freq_{Max}$	-	40	-	1400	kHz	
<b>CURRENT SENSE</b>							
Mean SEN Voltage	$V_{SEN}$	$V_{IN}=10V$ , $V1=1V$ , refer to test circuit (c)	95	100	105	mV	
<b>THERMAL OVERLOAD</b>							
Thermal Shutdown Threshold*	$T_{SD}$	-	145	165	175	$^{\circ}C$	
Thermal Shutdown Hysteresis*	$T_{SD-HYS}$	-	20	30	40	$^{\circ}C$	
<b>DIMMING</b>							
Duty Cycle Range of PWM Signal Applied to DIM pin	$Duty_{DIM}$	PWM frequency: 100Hz ~ 1kHz	1	-	100	%	

\*Guaranteed by Design.

Test Circuit for Electrical Characteristics

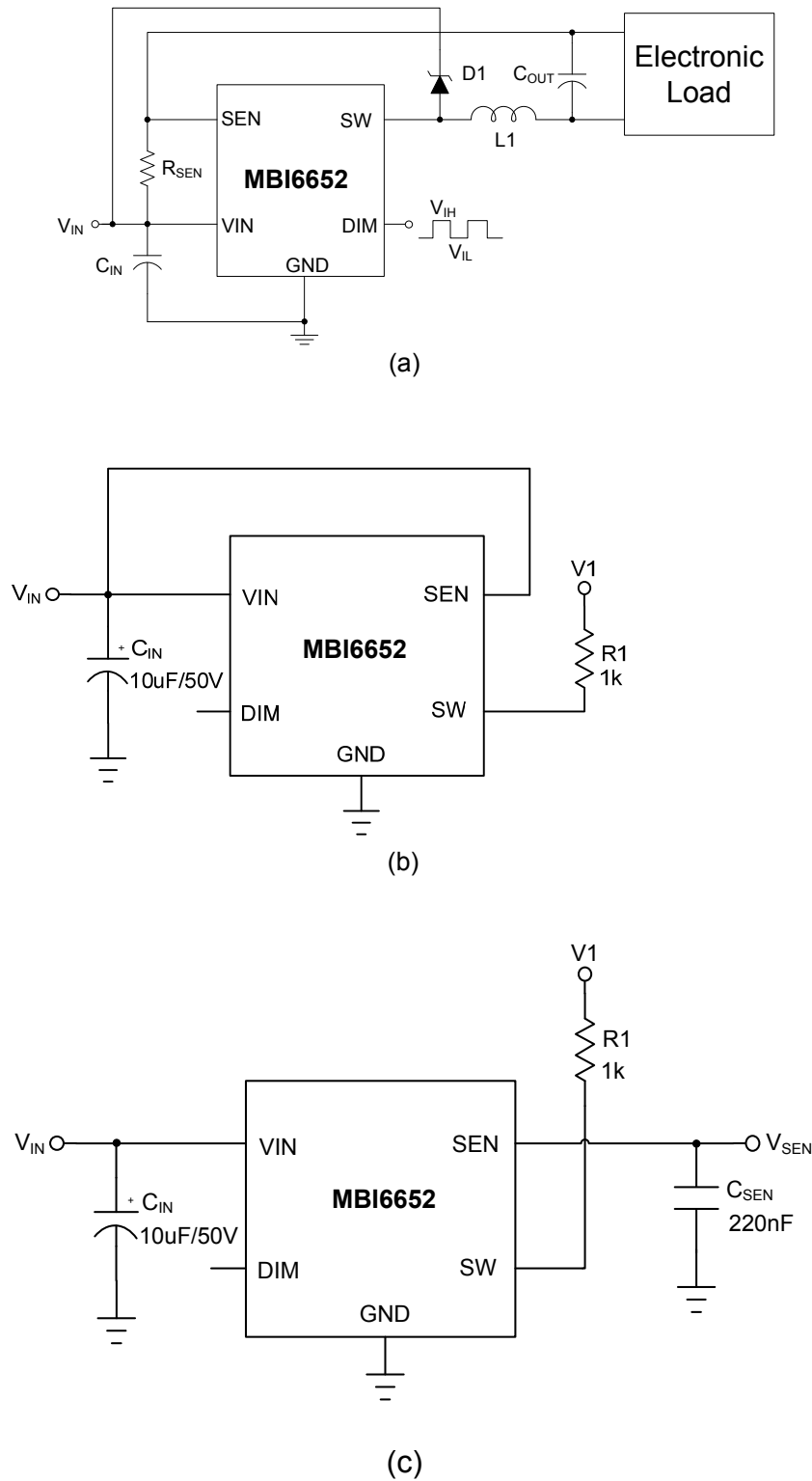

Figure 3

Typical Performance Characteristics

Please refer to Typical Application Circuit,  $V_{IN}=12V$ ,  $L1=68\mu H$ ,  $C_{IN}=C_{OUT}=10\mu F$ ,  $T_A=25^\circ C$ , unless otherwise specified.

1-LED  $V_F=3.6V$ ; 2-LED  $V_F=7.2V$ ; 3-LED  $V_F=10.8V$ ; 4-LED  $V_F=14.4V$ ; 5-LED  $V_F=18V$

1. Efficiency vs. Input Voltage at Various LED Cascaded Number

Efficiency vs. input voltage @  $L1=22\mu H$

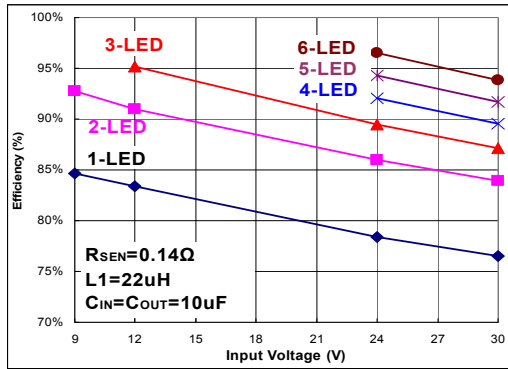

Fig 4.  $I_{OUT}=715\text{ mA}$

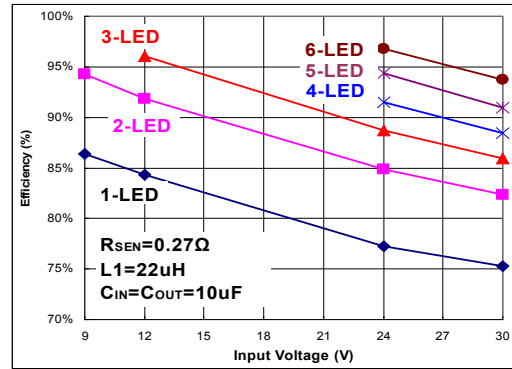

Fig 5.  $I_{OUT}=370\text{ mA}$

Efficiency vs. input voltage @  $L1=68\mu H$

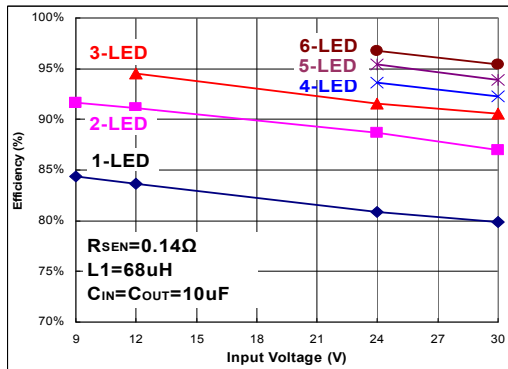

Fig 6.  $I_{OUT}=715\text{ mA}$

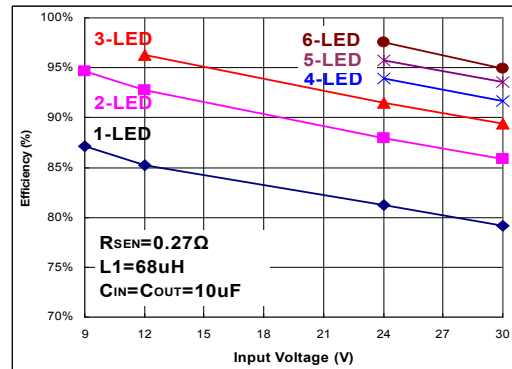

Fig 7.  $I_{OUT}=370\text{ mA}$

Efficiency vs. input voltage @  $L1=100\mu H$

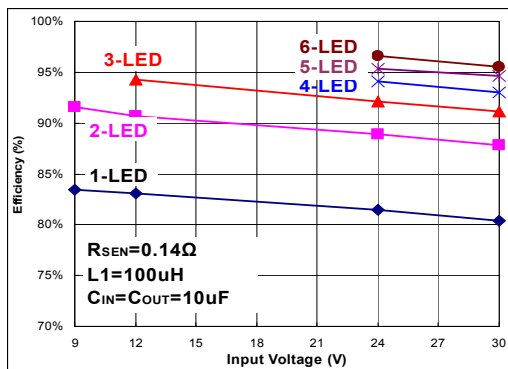

Fig 8.  $I_{OUT}=715\text{ mA}$

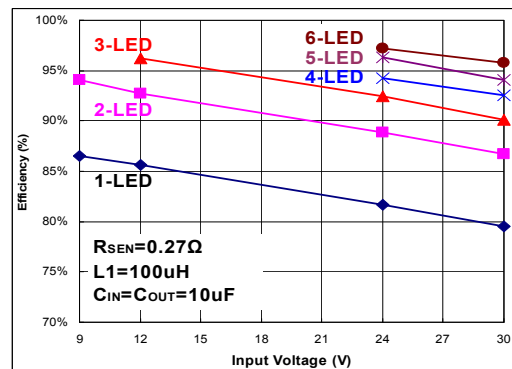

Fig 9.  $I_{OUT}=370\text{ mA}$

2. Efficiency vs. LED Cascaded Number at Various Input Voltage

Efficiency vs. LED cascaded number @ L1=22uH

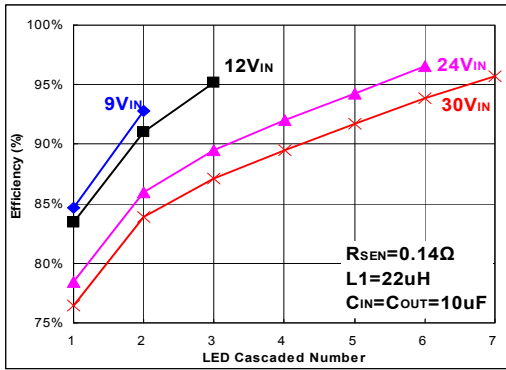

Fig 10. I<sub>OUT</sub>=715 mA

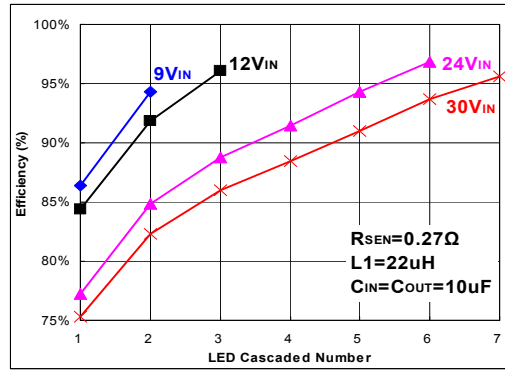

Fig 11. I<sub>OUT</sub>= 370 mA

Efficiency vs. LED cascaded number @ L1=68uH

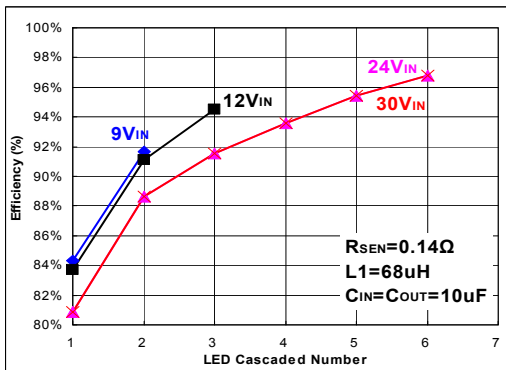

Fig 12. I<sub>OUT</sub>=715 mA

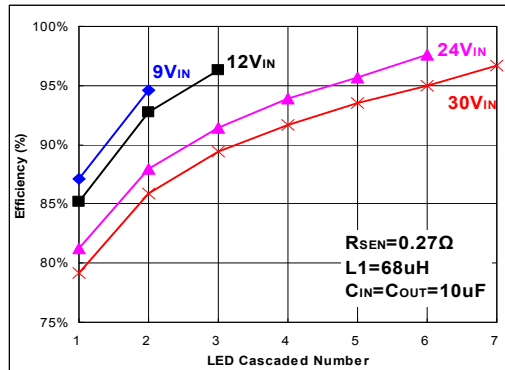

Fig 13. I<sub>OUT</sub>=370 mA

Efficiency vs. LED cascaded number @ L1=100uH

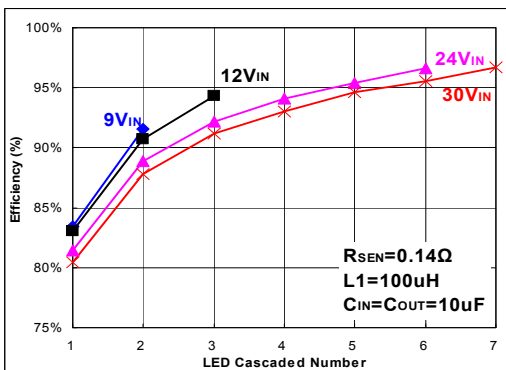

Fig 14. I<sub>OUT</sub>=715 mA

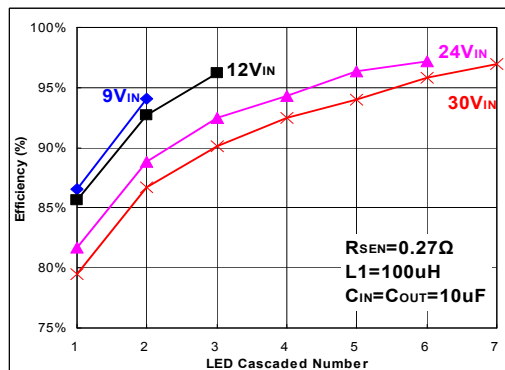

Fig 15. I<sub>OUT</sub>=370 mA



3. Output Current vs. Input Voltage at Various LED Cascaded Number

Output current vs. input voltage @ L1=22uH

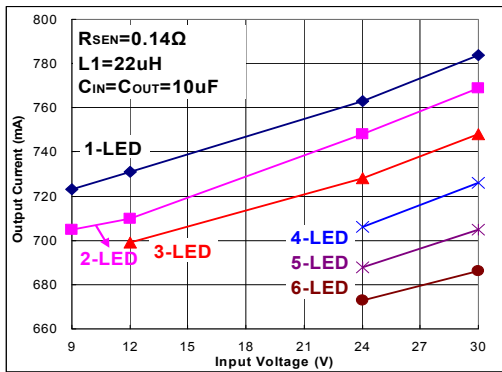

Fig 16. I<sub>OUT</sub>=715 mA

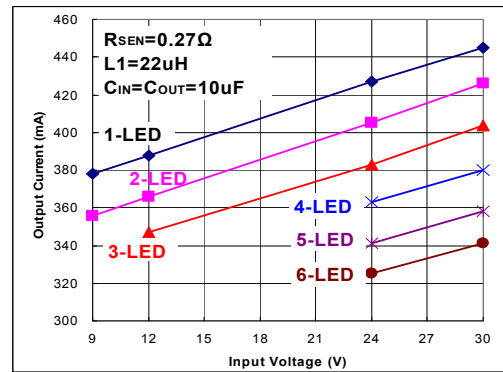

Fig 17. I<sub>OUT</sub>=370 mA

Output current vs. input voltage @ L1=68uH

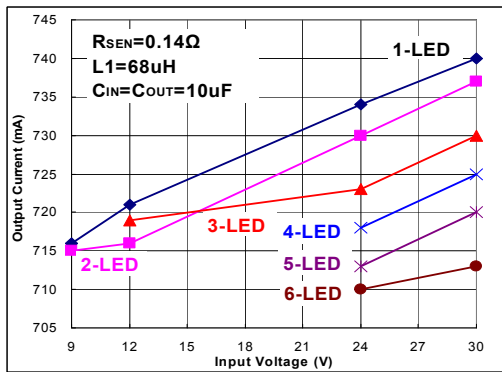

Fig 18. I<sub>OUT</sub>=715 mA

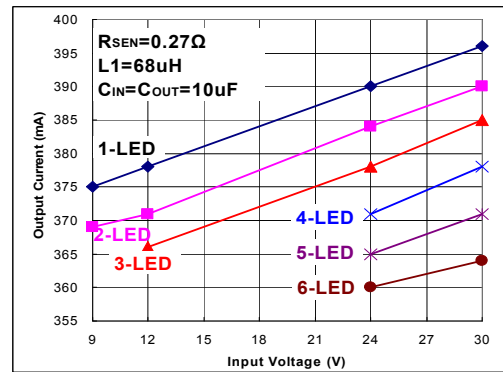

Fig 19. I<sub>OUT</sub>=370 mA

Output current vs. input voltage @ L1=100uH

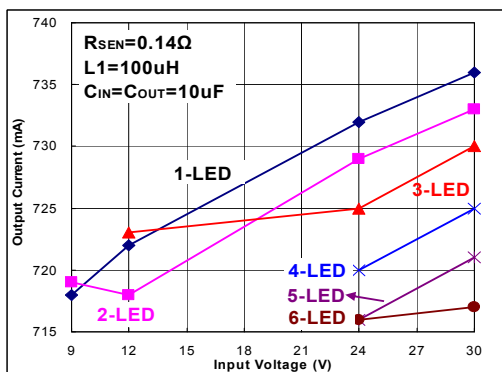

Fig 20. I<sub>OUT</sub>=715 mA

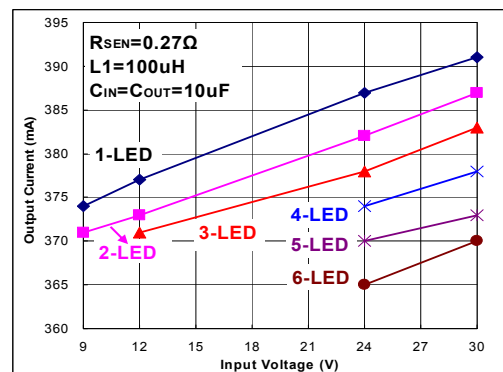

Fig 21. I<sub>OUT</sub>= 370 mA

4. Output Current vs. Input Voltage at Various Inductor

Output current vs. input voltage @ 1-LED in cascaded

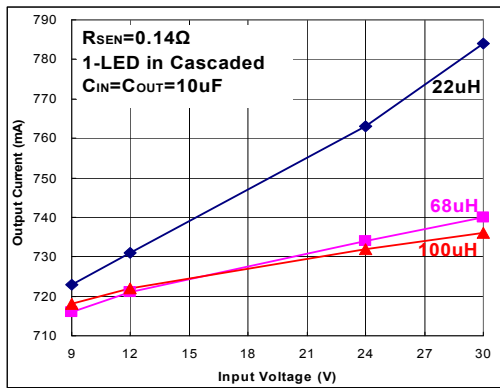

Fig 22.  $I_{OUT}=715$  mA

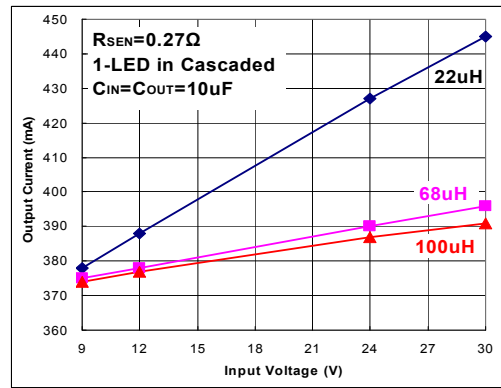

Fig 23.  $I_{OUT}=370$  mA

Output current vs. input voltage @ 2-LED in cascaded

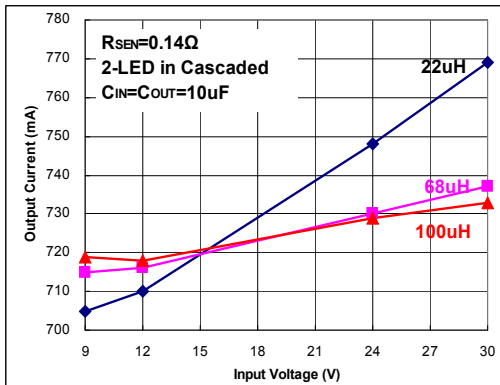

Fig 24.  $I_{OUT}=715$  mA

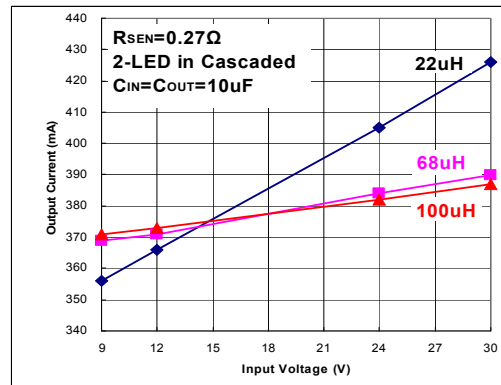

Fig 25.  $I_{OUT}=370$  mA

Output current vs. input voltage @ 3-LED in cascaded

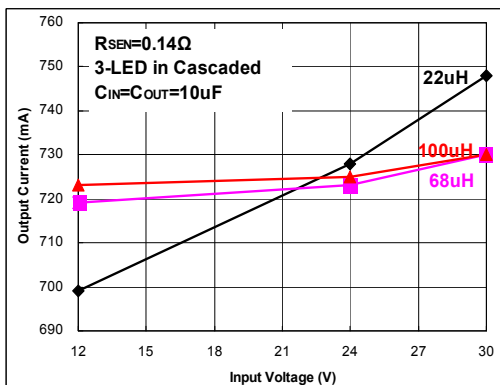

Fig 26.  $I_{OUT}=715$  mA

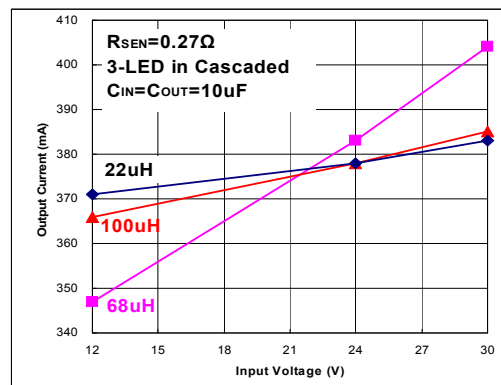

Fig 27.  $I_{OUT}=370$  mA

5. Output Current vs. LED Cascaded Number at Various Input Voltage

Output current vs. LED cascaded number @ L1=22uH

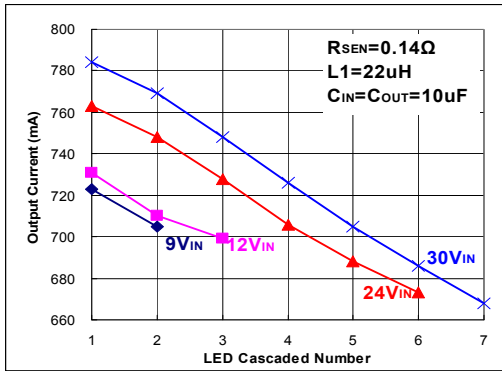

Fig 28. I<sub>OUT</sub>=715 mA

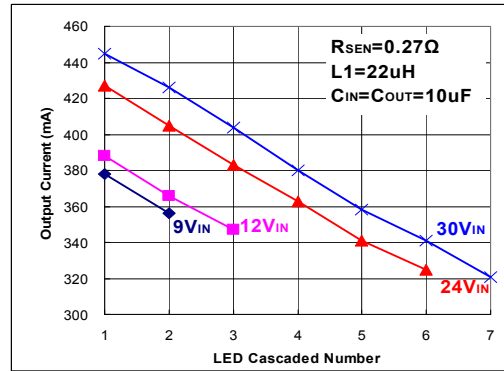

Fig 29. I<sub>OUT</sub>=370 mA

Output current vs. LED cascaded number @ L1=68uH

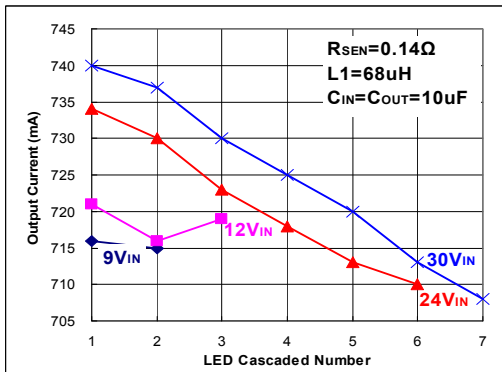

Fig 30. I<sub>OUT</sub>=715 mA

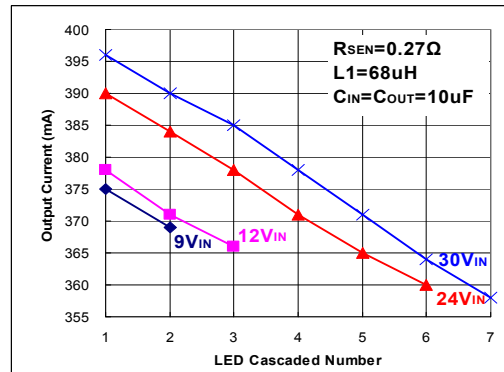

Fig 31. I<sub>OUT</sub>=370 mA

Output current vs. LED cascaded number @ L1=100uH

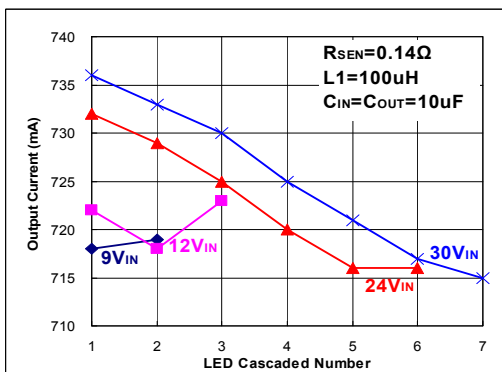

Fig 32. I<sub>OUT</sub>=715 mA

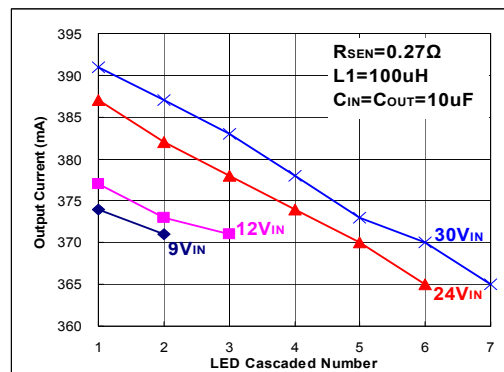

Fig 33. I<sub>OUT</sub>=370 mA

6. Output Current vs. LED Cascaded Number at Various Inductor

Output current vs. LED cascaded number @ VIN=12V

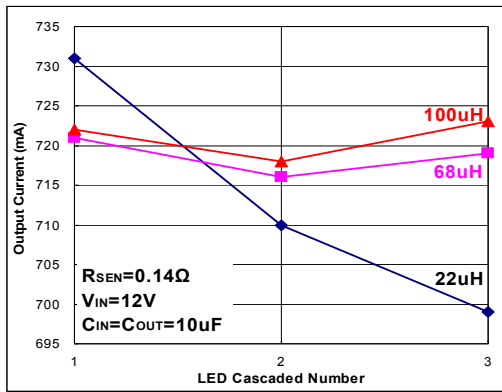

Fig 34. I<sub>OUT</sub>=715 mA

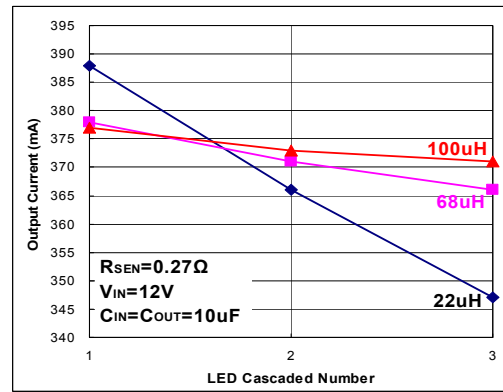

Fig 35. I<sub>OUT</sub>=370 mA

Output current vs. LED cascaded number @ VIN=24V

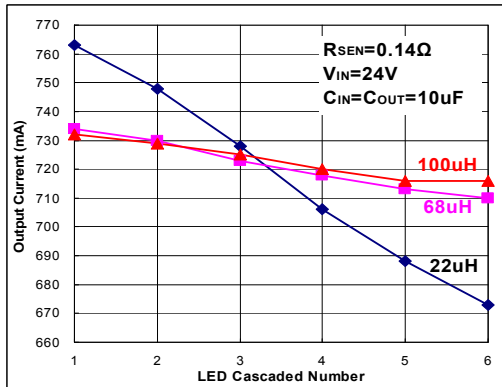

Fig 36. I<sub>OUT</sub>=715 mA

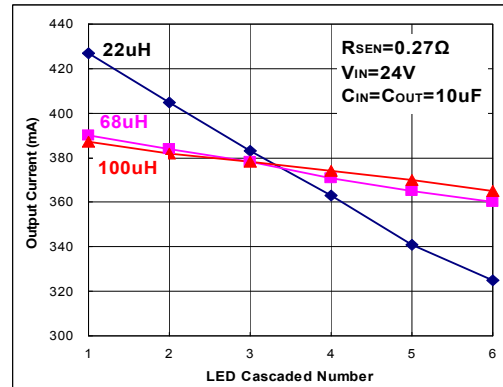

Fig 37. I<sub>OUT</sub>=370 mA

Output current vs. LED cascaded number @ VIN=30V

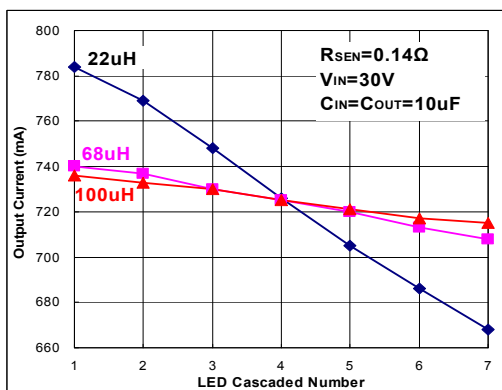

Fig 38. I<sub>OUT</sub>=715 mA

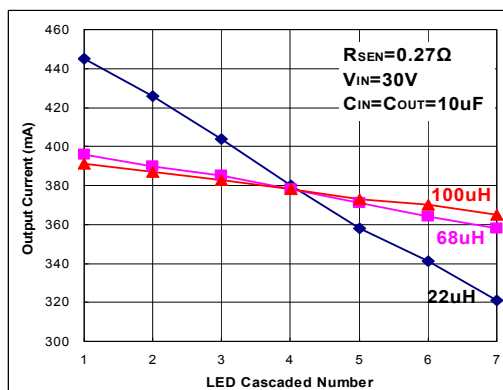

Fig 39. I<sub>OUT</sub>=370 mA

7. Switching Frequency vs. LED Cascaded Number at Various Inductor

Switching frequency vs. LED cascaded number @  $V_{IN}=12V$

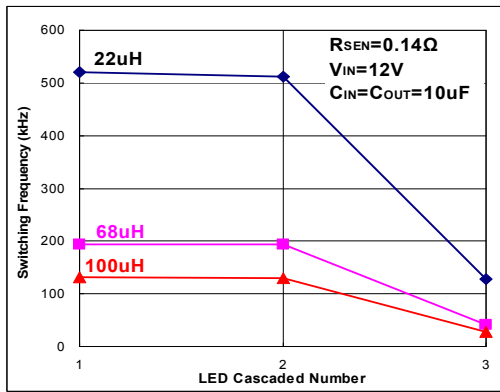

Fig 40.  $I_{OUT}=715\text{ mA}$

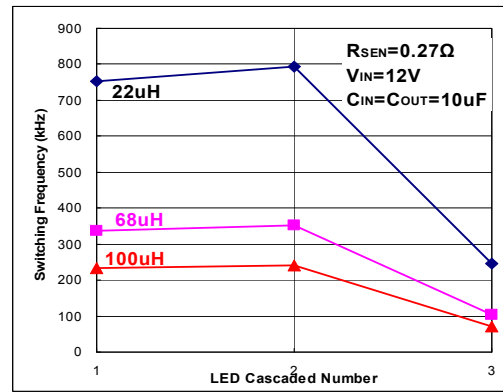

Fig 41.  $I_{OUT}=370\text{ mA}$

Switching frequency vs. LED cascaded number @  $V_{IN}=24V$

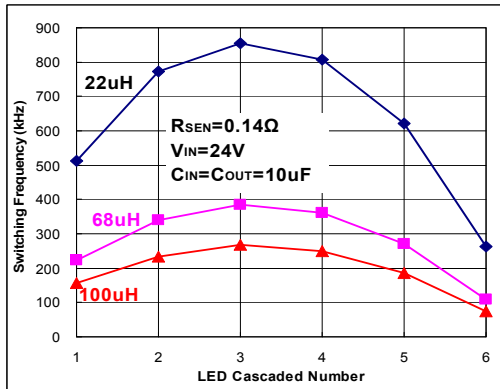

Fig 42.  $I_{OUT}=715\text{ mA}$

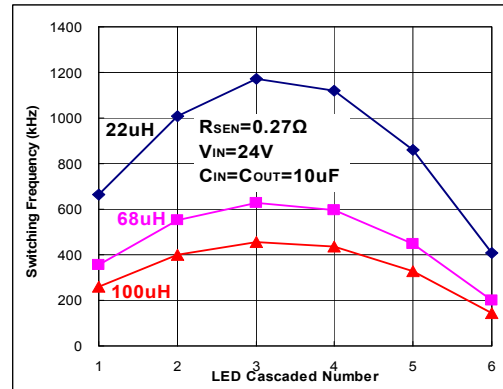

Fig 43.  $I_{OUT}=370\text{ mA}$

Switching frequency vs. LED cascaded number @  $V_{IN}=30V$

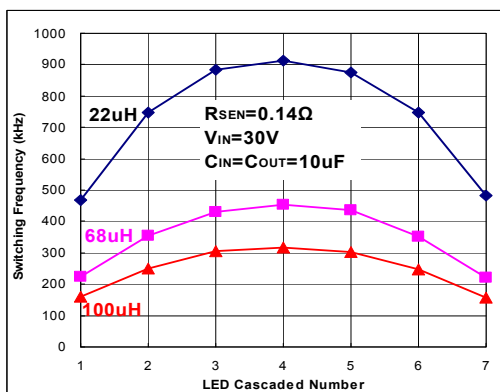

Fig 44.  $I_{OUT}=715\text{ mA}$

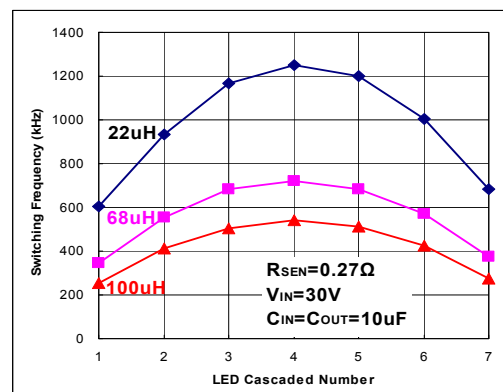

Fig 45.  $I_{OUT}=370\text{ mA}$

8. Miscellaneous

(a) Dimming and switching waveforms

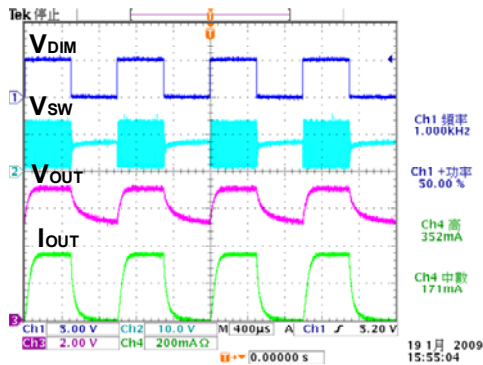

Fig 46. Dimming waveform  
( $V_{IN}=12V$ ,  $R_{SEN}=0.27\Omega$ , 2-LED)

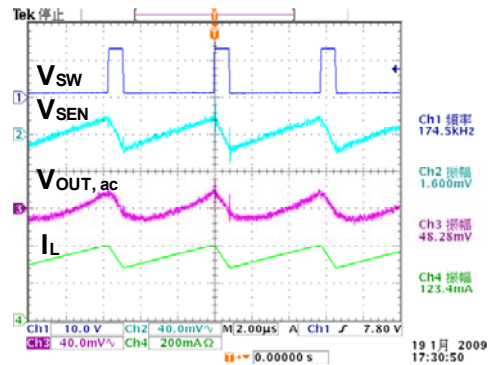

Fig 47. Switching waveform  
( $12V_{IN}$ ,  $3.6V_{OUT}$ ,  $R_{SEN}=0.27\Omega$ )

(b) Line transient response

Line transient response @  $V_{IN}=13V \leftrightarrow 24V$ ,  $V_{OUT}=10V$ ,  $R_{SEN}=0.27\Omega$

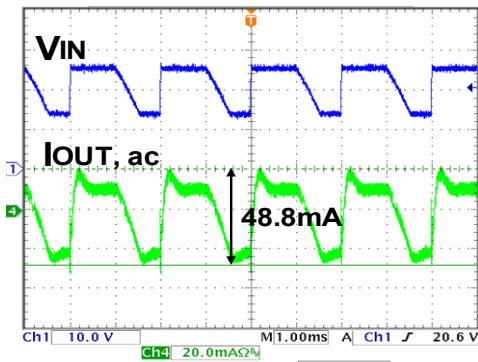

Fig 48.  $L1=22\mu H$

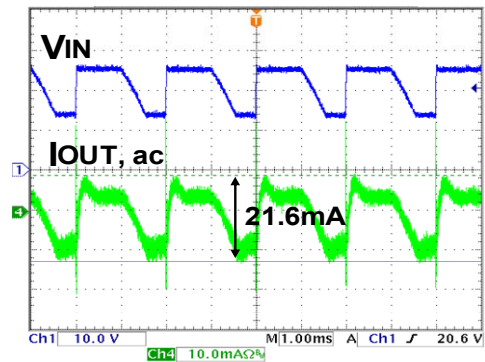

Fig49.  $L1=68\mu H$

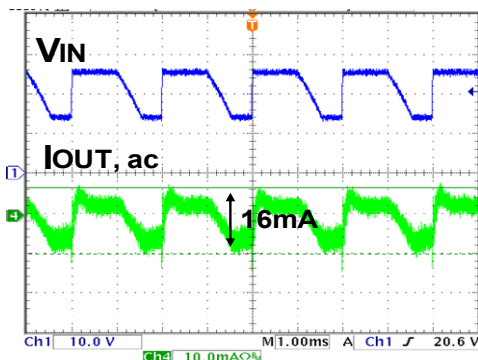

Fig 50.  $L1=100\mu H$

(c) Power supply hot plug-in waveforms

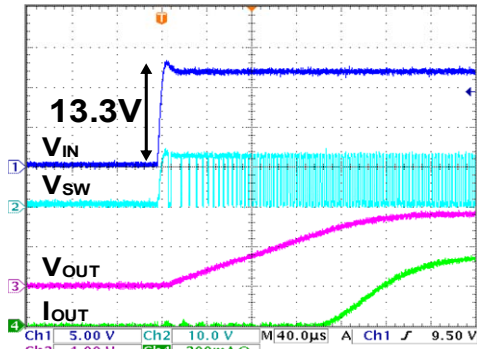

Fig 51.  $C_{IN}=C_{OUT}$ =Tantalum capacitor (10uF/50V)

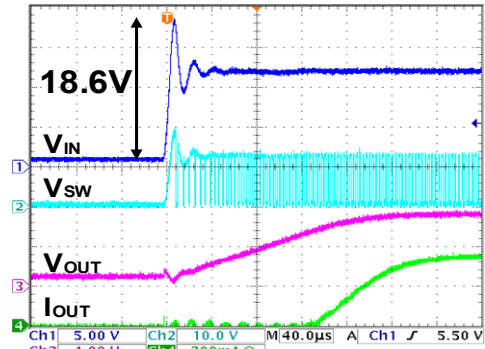

Fig 52.  $C_{IN}=C_{OUT}$ =Ceramic capacitor (2 x 4.7uF/35V)

(d) LED hot plug-in waveforms

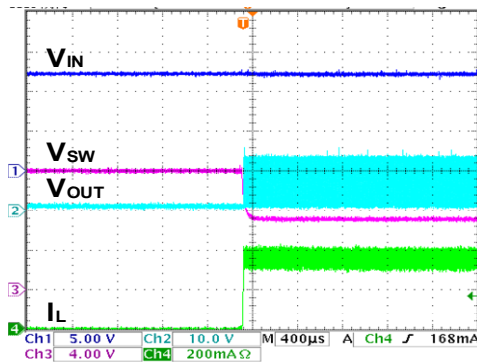

Fig 53.  $C_{IN}=C_{OUT}$ =Tantalum capacitor (10uF/50V)

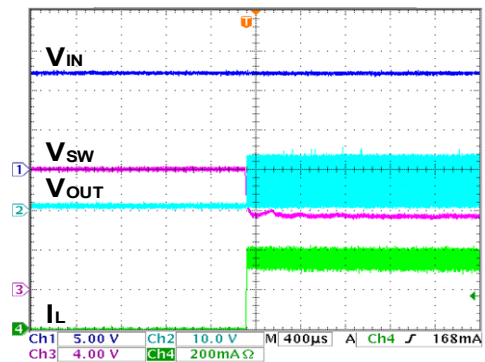

Fig 54.  $C_{IN}=C_{OUT}$ =Ceramic capacitor (2 x 4.7uF/35V)

(e) Internal Propagation Delay Time

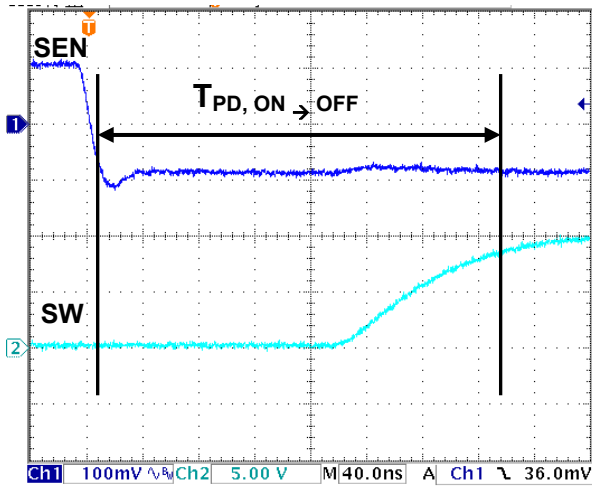

Fig 55

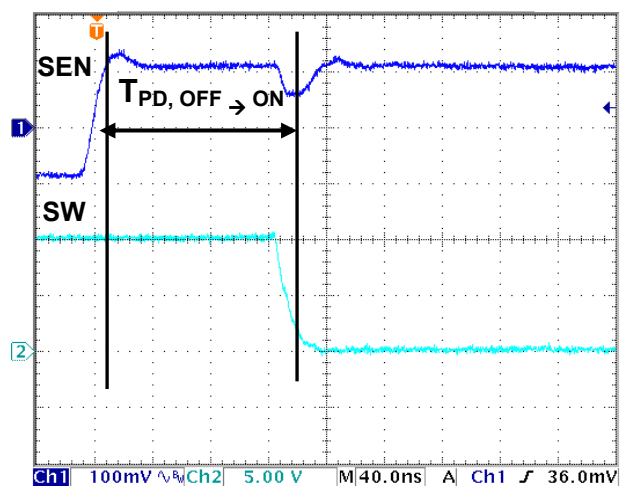

Fig 56

### Application Information

The MBI6652 is a simple and high efficient buck converter with capability to drive up to 750mA of loading. The MBI6652 adopts hysteretic PFM control scheme to regulate loading and input voltage variations. The hysteretic PFM control requires no loop compensation bringing very fast load transient response and achieving excellent efficiency at light loading.

#### Setting Output Current

The output current ( $I_{OUT}$ ) is set by an external resistor,  $R_{SEN}$ . The relationship between  $I_{OUT}$  and  $R_{SEN}$  is as below;

$$V_{SEN}=0.1V;$$

$$R_{SEN}=(V_{SEN}/I_{OUT})=(0.1V/I_{OUT});$$

$$I_{OUT}=(V_{SEN}/R_{SEN})=(0.1V/R_{SEN})$$

where  $R_{SEN}$  is the resistance of the external resistor connecting to SEN terminal and  $V_{SEN}$  is the voltage of external resistor. The magnitude of current (as a function of  $R_{SEN}$ ) is around 700mA at 0.143Ω.

#### Minimum Input Voltage and Start-up Protection

The minimum input voltage is the sum of the voltage drops on  $R_{SEN}$ ,  $R_S$ , DCR of L1,  $R_{ds(on)}$  of internal MOSFET and the total forward voltage of LEDs. The dynamic resistance of LED,  $R_S$ , is the inverse of the slope in linear forward voltage model for LED. This electrical characteristic can be provided by LED manufacturers. The equivalent impedance of the MBI6652 application circuit is shown in Figure 57. As the input voltage is smaller than minimum input voltage such as start-up condition, the output current will be larger than the preset output current. Thus, under this circumstance, the output current is limited to 1.15 times of preset one as shown in Figure 58.

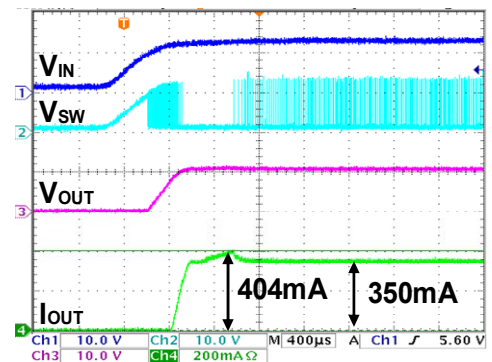
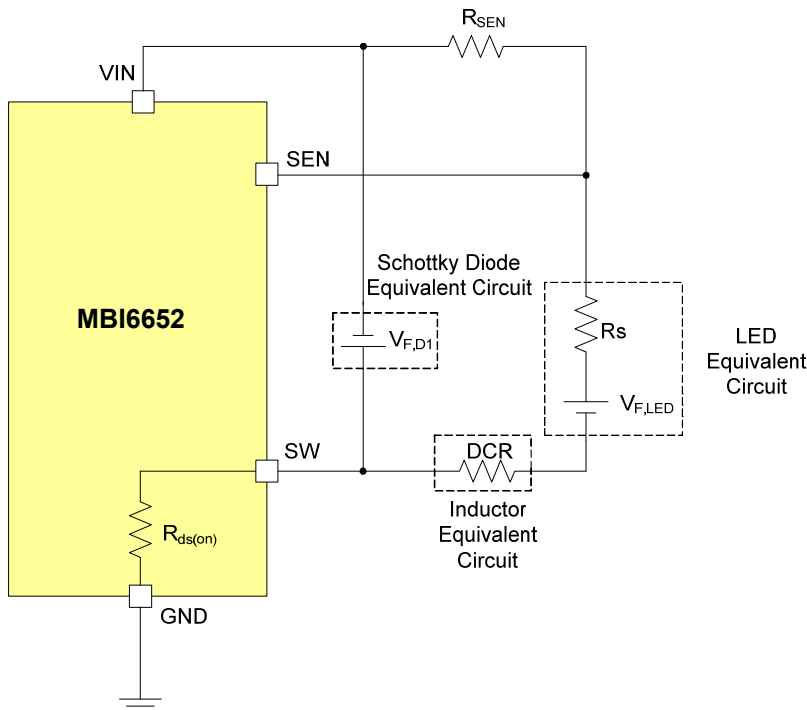

Figure 58. The start-up waveform @  $V_{IN}=12V$ ,  $V_{OUT}= 10.8$ ,  $R_{SEN}=0.27\Omega$

Figure 57. The equivalent impedance in a MBI6652 application circuit



**Dimming**

The dimming of LEDs can be performed by applying PWM signals to DIM pin. A logic low (below 0.5V) at DIM will disable the internal MOSFET and shut off the current flow to the LED array. An internal pull-up circuit ensures that the MBI6652 is ON when DIM pin is unconnected. Therefore, the need for an external pull-up resistor will be eliminated. The following Figure 59 and 60 show good linearity in dimming application of MBI6652.

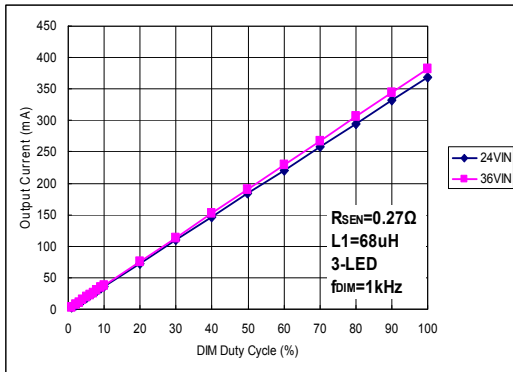

Figure 59. DIM duty cycle: 1% ~ 100%

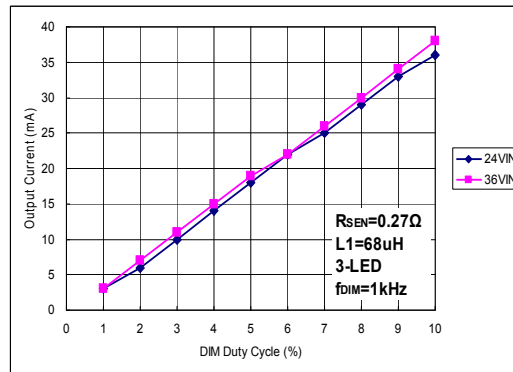

Figure 60. DIM duty cycle: 1% ~ 10%

**LED Open-Circuit Protection**

When any LED connecting to the MBI6652 is open-circuited, the output current of MBI6652 will be turned off. The waveform is shown in Figure 61.

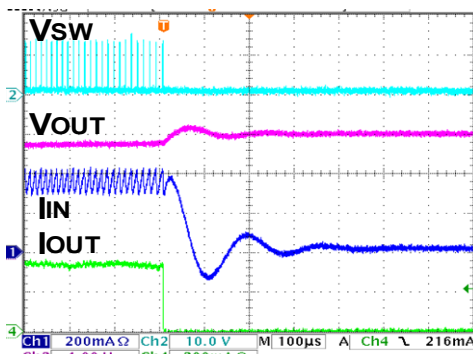

Figure 61. Open-circuit protection

**LED Short-Circuit Protection**

When any LED connecting to the MBI6652 is short-circuited, the output current of MBI6652 will still be limited to its preset value as shown in Figure 62.

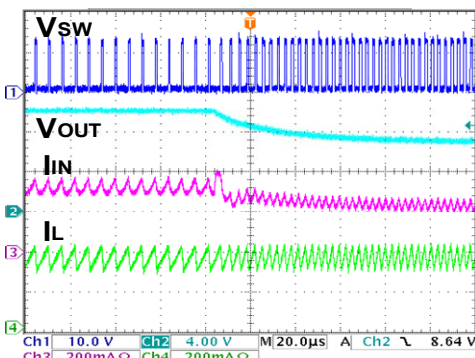

Figure 62. Short-circuit protection

**TP Function (Thermal Protection)**

When the junction temperature exceeds the threshold,  $T_x$  (165°C), TP function turns off the output current. The waveform can refer to Figure 63. The SW stops switching and the output current will be turned off. Thus, the junction temperature starts to decrease. As soon as the temperature is below 135°C, the output current will be turned on again. The switching of on-state and off-state are at a high frequency thus the blinking is imperceptible. The average output current is limited and therefore, the driver is protected from being overheated.

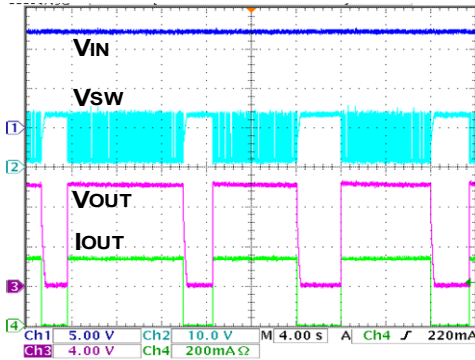

Figure 63. Thermal protection

**Design Consideration**

**Switching Frequency**

To achieve better output current accuracy, the switching frequency should be determined by minimum on/off time of SW waveform. For example, if the duty cycle of MBI6652 is larger than 0.5, then the switching frequency should be determined by the minimum off time, and vice versa. Thus the switching frequency of MBI6652 is:

$$f_{sw} = \frac{1}{T_S} = \frac{1}{\frac{T_{OFF,min}}{(1-D)}} , \text{ when the duty cycle is larger than 0.5} \tag{1}$$

$$\text{or } f_{sw} = \frac{1}{T_S} = \frac{1}{\frac{T_{ON,min}}{D}} , \text{ when the duty cycle is smaller than 0.5.} \tag{2}$$

The switching frequency is related to efficiency (better at low frequency), the size/cost of components (smaller/ cheaper at high frequency), and the amplitude of output ripple voltage and current (smaller at high frequency). The slower switching frequency comes from the large value of inductor. In many applications, the sensitivity of EMI limits the switching frequency of MBI6652. The switching frequency can be ranged from 40kHz to 1.4MHz.

**LED Ripple Current**

A LED constant current driver, such as MBI6652, is designed to control the current through the cascaded LED, instead of the voltage across it. Higher LED ripple current allows the use of smaller inductance, smaller output capacitance and even without an output capacitor. The advantages of higher LED ripple current are to minimize PCB size and reduce cost because of no output capacitor. Lower LED ripple current requires larger inductance, and output capacitor. The advantages of lower LED ripple current are to extend LED life time and to reduce heating of LED. The recommended ripple current is from 5% to 20% of normal LED current.

Component Selection

**Inductor Selection**

The inductance is determined by two factors: the switching frequency and the inductor ripple current. The calculation of the inductance, L1, can be described as

$$L1 > (V_{IN} - V_{OUT} - V_{SEN} - (R_{ds(on)} \times I_{OUT})) \times \frac{D}{f_{SW} \times \Delta I_L}$$

where

**R<sub>ds(on)</sub>** is the on-resistance of internal MOSFET of the MBI6652. The typical is 0.45Ω at 12V<sub>IN</sub>.

**D** is the duty cycle of the MBI6652, D=V<sub>OUT</sub>/V<sub>IN</sub>.

**f<sub>sw</sub>** is the switching frequency of the MBI6652.

**ΔI<sub>L</sub>** is the ripple current of inductor, ΔI<sub>L</sub>=(1.15xI<sub>OUT</sub>)-(0.85xI<sub>OUT</sub>)=0.3xI<sub>OUT</sub>.

When selecting an inductor, not only the inductance but also the saturation current that should be considered as the factors to affect the performance of module. In general, it is recommended to choose an inductor with 1.5 times of LED current as the saturation current. Also, the larger inductance gains the better line/load regulation. However, the inductance and saturation current become a trade-off at the same inductor size. An inductor with shield is recommended to reduce the EMI interference, however, this is another trade-off with heat dissipation.

**Schottky Diode Selection**

The MBI6652 needs a flywheel diode, D1, to carry the inductor current when the MOSFET is off. The recommended flywheel diode is schottky diode with low forward voltage for better efficiency. Two factors determine the selection of schottky diode. One is the maximum reverse voltage. The recommended rated voltage of the reverse voltage is at least 1.5 times of input voltage. The other is the maximum forward current, which works when the MOSFET is off. And the recommended forward current is 1.5 times of output current. Users should carefully choose an appropriate schottky diode which can perform low leakage current at high temperature.

**Input Capacitor Selection**

The input capacitor,  $C_{IN}$ , can supply pulses of current for the MBI6652 when the MOSFET is ON. And  $C_{IN}$  is charged by input voltage when the MOSFET is OFF. As the input voltage is lower than the tolerable input voltage, the internal MOSFET of the MBI6652 remains constantly ON, and the LED current is limited to 1.15 times of normal current. The recommended value of input capacitor is 10 $\mu$ F to stabilize the lighting system. The rated voltage of input capacitor should be at least 1.5 times of input voltage. Compromising availability and cost, an electrolytic capacitor is more frequently used.

For system stability, placing the  $C_{IN}$  to the VIN pin of MBI6651 as close as possible is recommended. However, the actual PCB layout and size might limit this applicability. Therefore, it is suggested to position a tiny bypass capacitor,  $C_{BP}$  to the VIN and GND pins of MBI6651 as close as possible, and parallel with the  $C_{IN}$  to enhance power noise injection capability. The recommend capacitance range is from 0.1 $\mu$ F to 1 $\mu$ F, and ceramic type is a good option.

The rated voltage, capacitance, and the maximum ripple current are the major concerns when selecting an input capacitor. It is important to carefully select the specification of maximum ripple current of input capacitor when in application. Both the IC and the capacitor may be damaged, if the rated ripple current of the selected capacitor is insufficient. In general, the ripple current is related to the inductor ripple current. The maximum ripple current specification should be larger than 1.3 times of the inductor ripple current.

A tantalum or ceramic capacitor can also be used as an input capacitor. The rated voltage of input capacitor should be at least 1.5 times of input voltage. A tantalum or ceramic capacitor can be used as an input capacitor. The advantages of tantalum capacitor are high capacitance and low ESR. The advantages of ceramic capacitor are high frequency characteristic, small size and low cost. Due to low ESR characteristic of ceramic capacitor, please do not use hot plugging. Users can choose an appropriate one for their applications.

**Output Capacitor Selection (Optional)**

A capacitor paralleled with cascaded LED can reduce the LED ripple current and allow smaller inductance.

**PCB Layout Consideration**

To enhance the efficiency and stabilize the system, careful considerations of PCB layout is important. There are several factors should be considered.

1. A complete ground area is helpful to eliminate the switching noise.
2. Keep the IC's GND pin and the ground leads of input and output filter capacitors less than 5mm.
3. To maximize output power efficiency and minimize output ripple voltage, use a ground plane and solder the IC's GND pin directly to the ground plane.
4. To stabilize the system, the heat sink of the MBI6652 is recommended to connect to ground plane directly.
5. Enhance the heat dissipation, the area of ground plane, which IC's heat sink is soldered on, should be as large as possible.
6. The input capacitor should be placed to IC's VIN pin as close as possible.
7. To avoid the parasitic effect of trace, the  $R_{SEN}$  should be placed to IC's VIN and SEN pins as close as possible.
8. The area, which is composed of IC's SW pin, schottky diode and inductor, should be wide and short.
9. The path, which flows large current, should be wide and short to eliminate the parasite element.
10. When SW is ON/OFF, the direction of power loop should keep the same way to enhance the efficiency. The sketch is shown as Figure 64.
11. To avoid unexpected damage or malfunction to the driver board, users should pay attention to the quality of soldering in the PCB by checking if cold welding or cold joint happens between the pins of IC and the PCB.

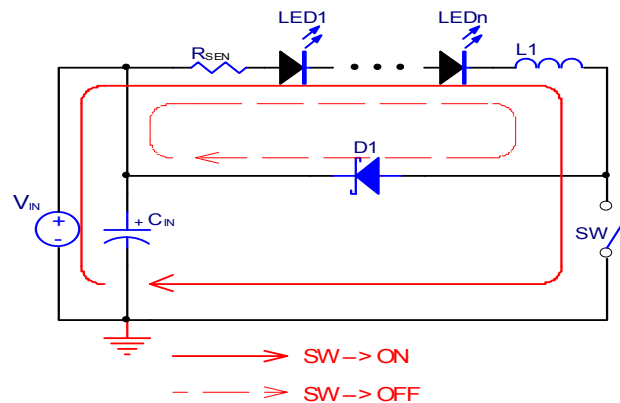

Figure 64. Power loop of MBI6652

**PCB Layout**

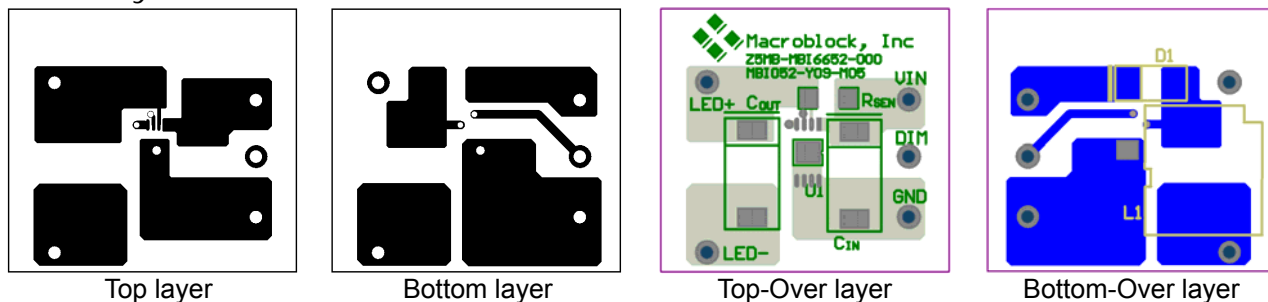
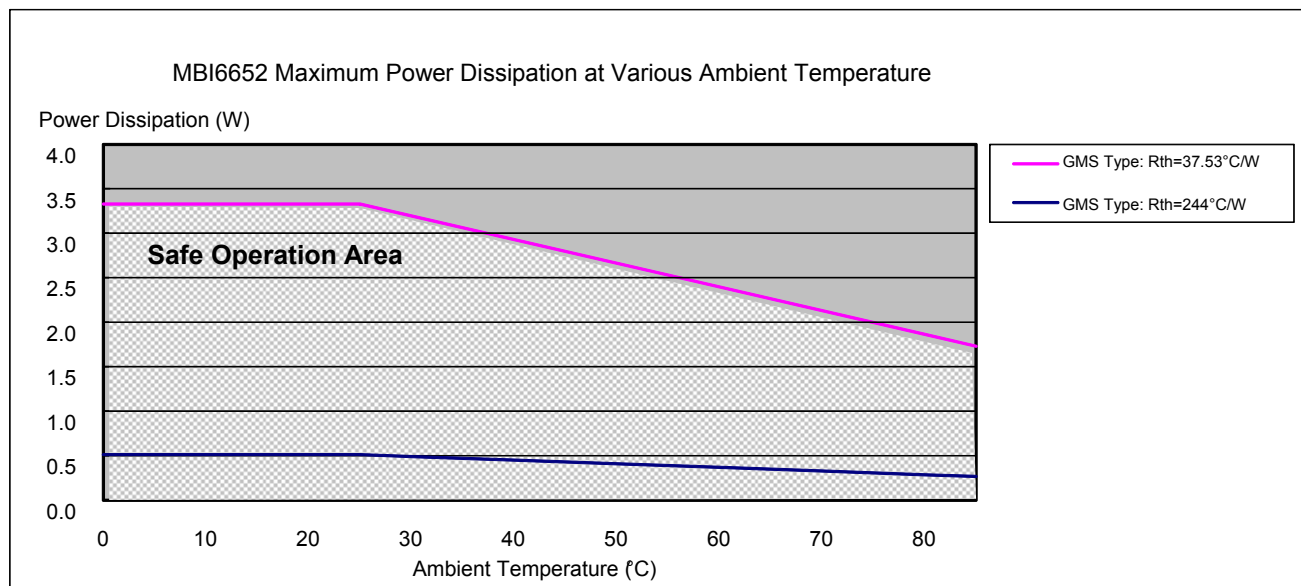

Figure 65. The layout diagram of the MBI6652 GMS

Package Power Dissipation (PD)

The maximum power dissipation,  $P_D(max)=(T_j-T_a)/R_{th(j-a)}$ , decreases as the ambient temperature increases.



Soldering Process of "Pb-free & Green" Package Plating\*

Macroblock has defined "Pb-Free & Green" to mean semiconductor products that are compatible with the current RoHS requirements and selected 100% pure tin (Sn) to provide forward and backward compatibility with both the current industry-standard SnPb-based soldering processes and higher-temperature Pb-free processes. Pure tin is widely accepted by customers and suppliers of electronic devices in Europe, Asia and the US as the lead-free surface finish of choice to replace tin-lead. Also, it adopts tin/lead (SnPb) solder paste, and please refer to the JEDEC J-STD-020C for the temperature of solder bath. However, in the whole Pb-free soldering processes and materials, 100% pure tin (Sn) will all require from 245 °C to 260 °C for proper soldering on boards, referring to JEDEC J-STD-020C as shown below.

For managing MSL3 Package, it should refer to JEDEC J-STD-020C about floor life management & refer to JEDEC J-STD-033C about re-bake condition while IC's floor life exceeds MSL3 limitation.

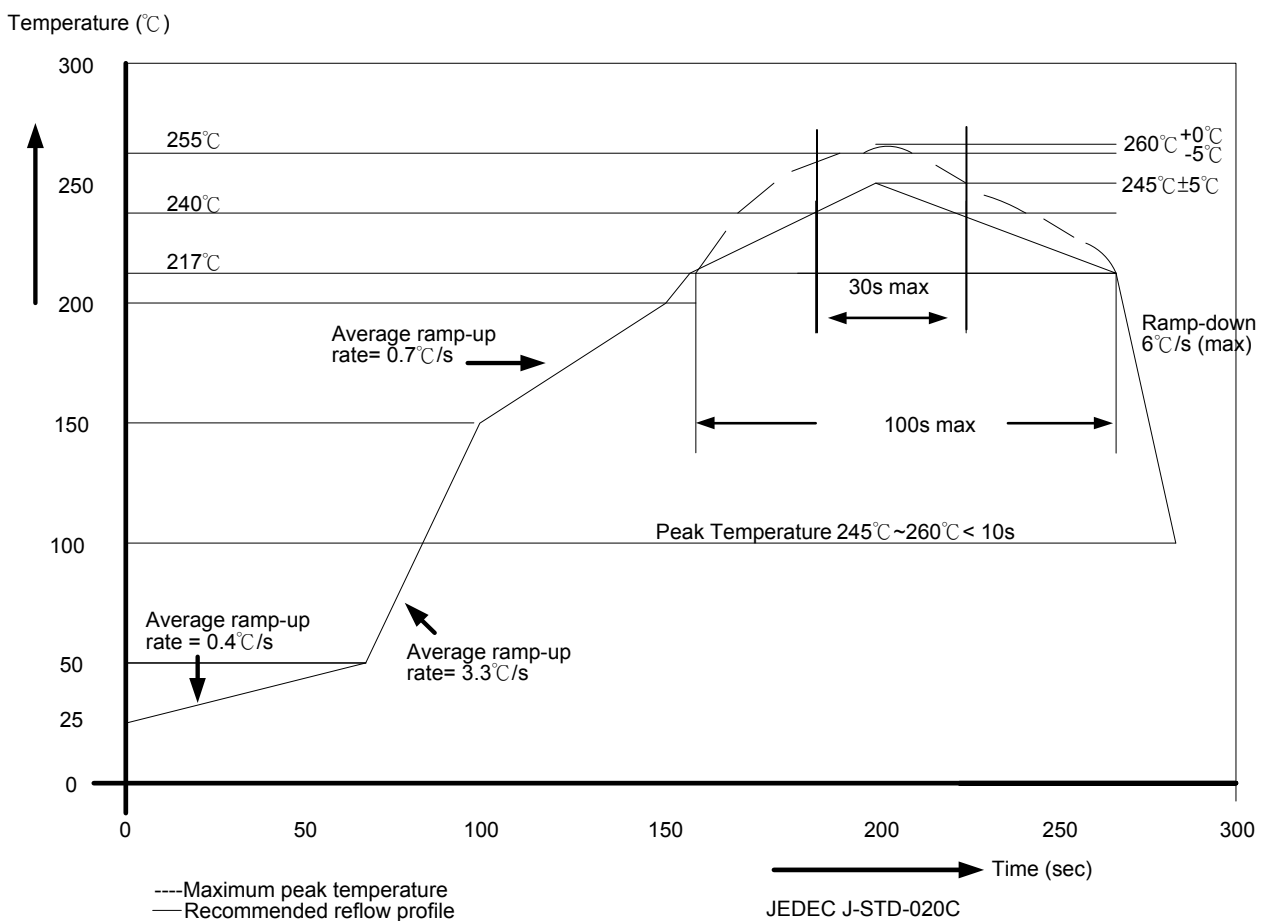

Package Thickness	Volume mm <sup>3</sup> <350	Volume mm <sup>3</sup> 350-2000	Volume mm <sup>3</sup> ≥ 2000
<1.6mm	260 +0 °C	260 +0 °C	260 +0 °C
1.6mm – 2.5mm	260 +0 °C	250 +0 °C	245 +0 °C
≥ 2.5mm	250 +0 °C	245 +0 °C	245 +0 °C

\*Note: For details, please refer to Macroblock's "Policy on Pb-free & Green Package".

Outline Drawing

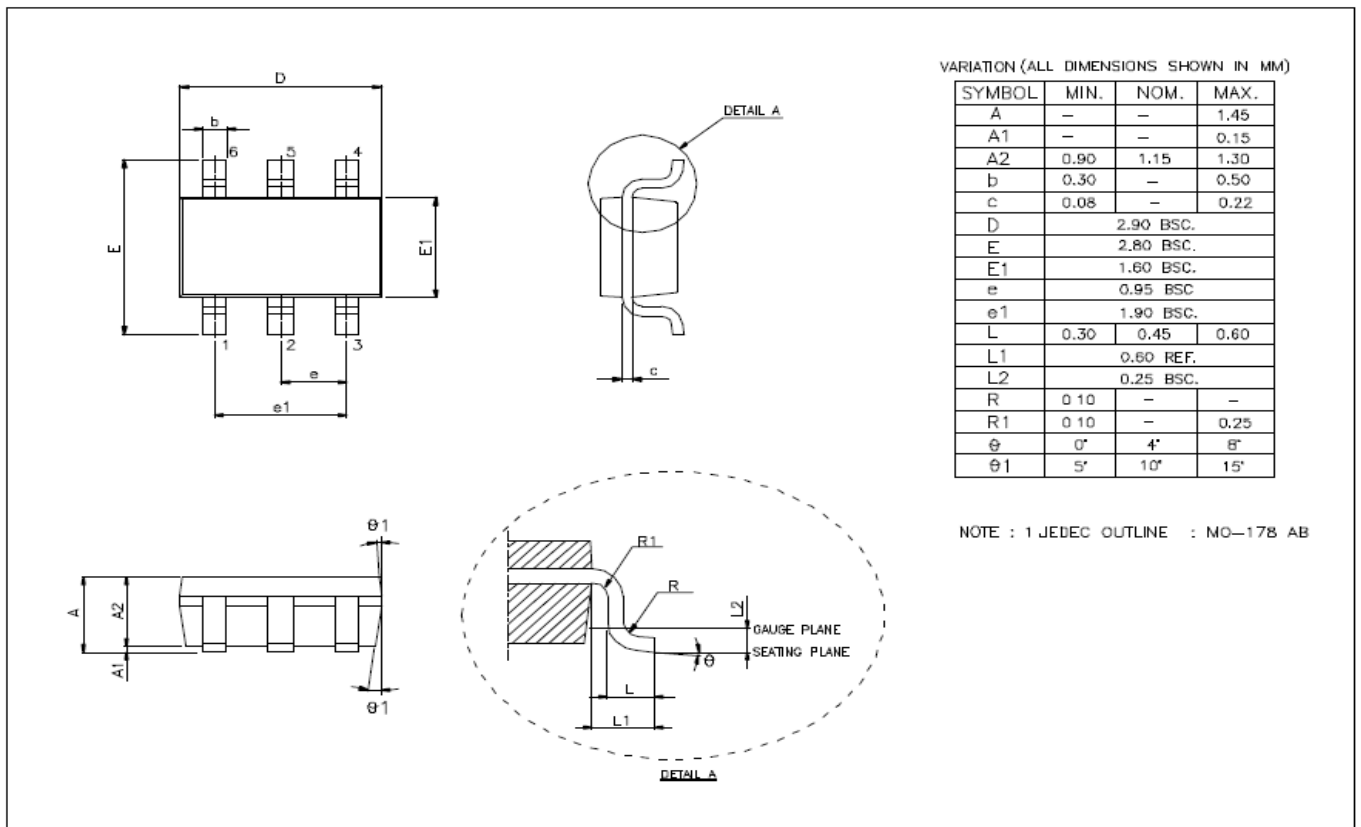

MBI6652GST Outline Drawing

Note1: The unit for the outline drawing is mm.

Note2: Please use the maximum dimensions for the thermal pad layout. To avoid the short circuit risk, the vias or circuit traces shall not pass through the maximum area of thermal pad.



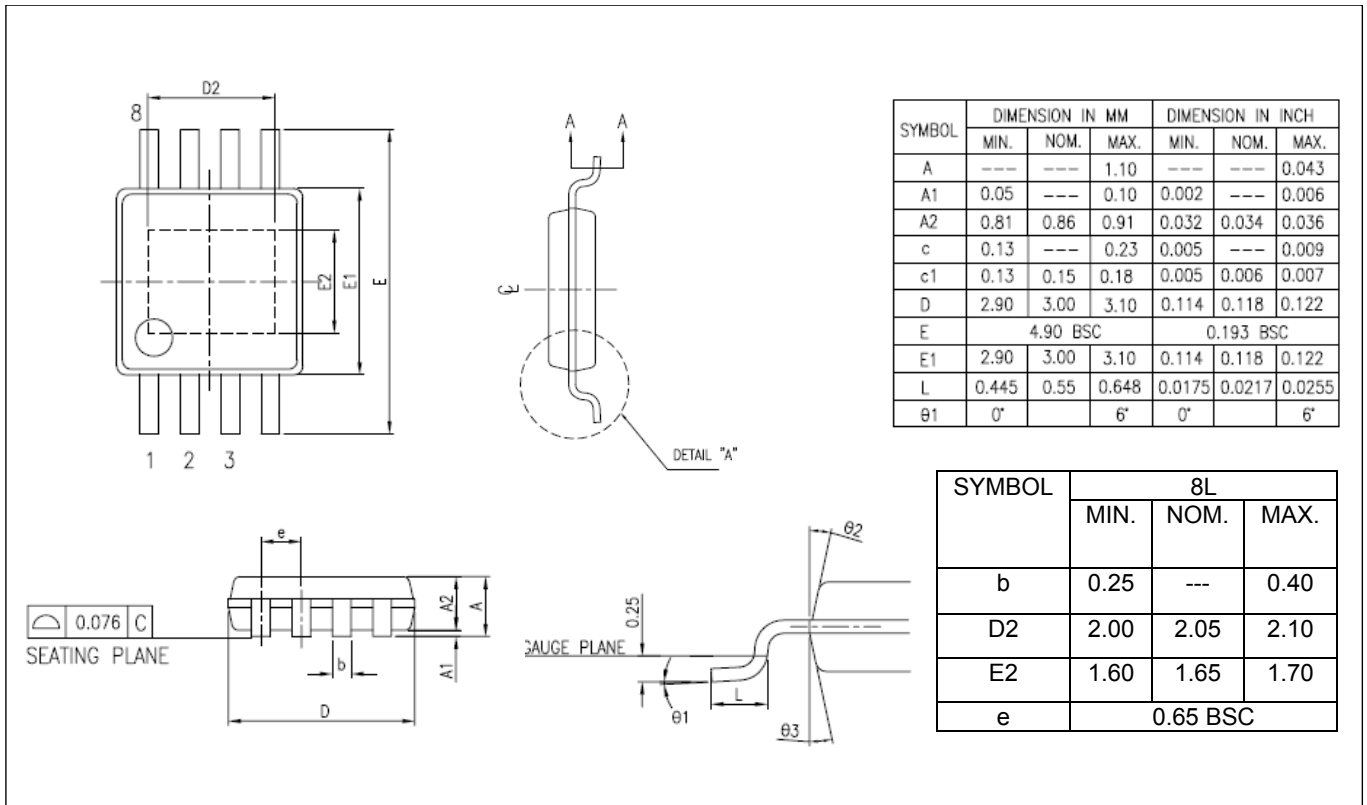

MBI6652GMS Outline Drawing

Note1: The unit for the outline drawing is mm.

Note2: Please use the maximum dimensions for the thermal pad layout. To avoid the short circuit risk, the vias or circuit traces shall not pass through the maximum area of thermal pad.

Product Top Mark Information

**GST**

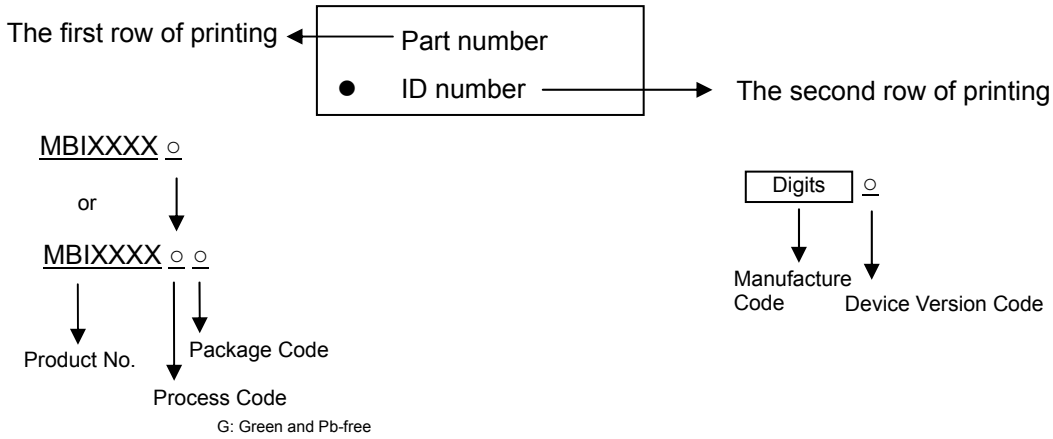

**GMS**

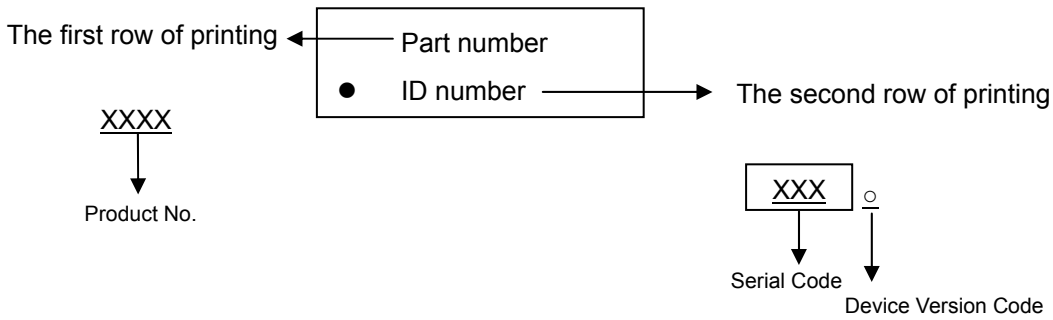

Product Revision History

Datasheet version	Device Version Code
VA.00	A

Product Ordering Information

Part Number	“Pb-free” Package Type	Weight (g)
MBI6652GST	SOT-23-6L	0.016g
MBI6652GMS	MSOP-8L	0.0233g

\*Please place your order with the “**product ordering number**” information on your purchase order (PO).

## Disclaimer

Macroblock reserves the right to make changes, corrections, modifications, and improvements to their products and documents or discontinue any product or service. Customers are advised to consult their sales representative for the latest product information before ordering. All products are sold subject to the terms and conditions supplied at the time of order acknowledgement, including those pertaining to warranty, patent infringement, and limitation of liability. Macroblock's products are not designed to be used as components in device intended to support or sustain life or in military applications. Use of Macroblock's products in components intended for surgical implant into the body, or other applications in which failure of Macroblock's products could create a situation where personal death or injury may occur, is not authorized without the express written approval of the Managing Director of Macroblock. Macroblock will not be held liable for any damages or claims resulting from the use of its products in medical and military applications. All text, images, logos and information contained on this document is the intellectual property of Macroblock. Unauthorized reproduction, duplication, extraction, use or disclosure of the above mentioned intellectual property will be deemed as infringement.