

9001 Series

DIN41612 Q Type Male

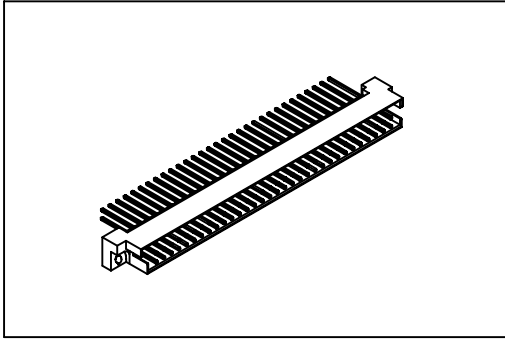

Material:

Housing: 30% Glass filled PBT UL94V-0.
 Contacts: Brass.

Electrical Characteristics:

Current Rating: 2 AMP.
 Dielectric Withstanding Voltage: AC 1000V For 1 minute.
 Insulator Resistance: 1000MΩmin. at DC 500V.
 Contact Resistance: 30mΩmax. at DC 100mA.
 Operating Temperature: -55°C ~ +105°C.

Features:

- * UL, cUL listing.
- * Mates with Female 2Row
 9001-3264,3232 B Type.
 9001-3464,3432 Q Type.
 9001-3264 IDC Type.

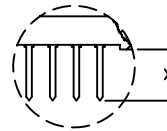
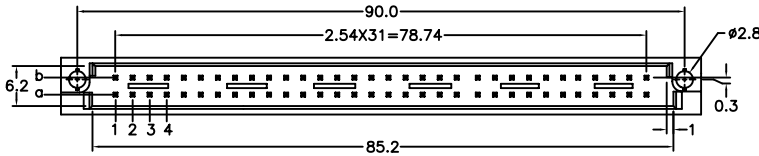

Dip Type

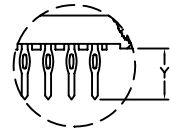

Press Fit Type

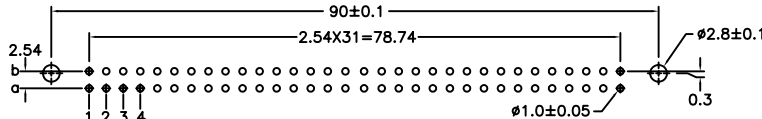
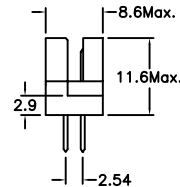
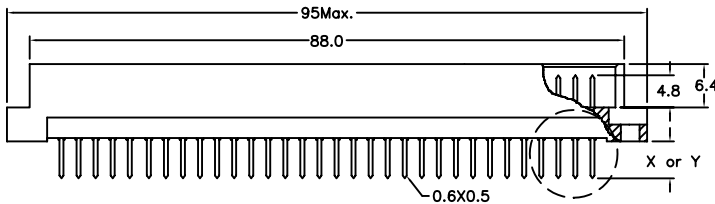

P.C. Board Layout

Length	1	2	W1	W2
X	4.0	2.5	13	17
Y	4.6	6.3	13	17
Pitch	Position	Rows with Contacts	Contact Arrange	
2.54mm	64	a b		
	32	a -		
5.08mm	32	a b		
	16	a -		

Ordering information

9001- 3 3 64 1 C 00 P L1 A
 Series 3: 2.54mm 3: Male Position 1: Dip Length C: Dip Tin 00: G/F Blank: Dip Blank: W/O A: Tray
 4: 5.08mm 2: Dip Length Contact Gold 10: 10μ" P: Press Fit Lock Package
 W1: Dip Length G: Gold 15: 15μ" L1: With Lock
 W2: Dip Length 30: 30μ" See Page CA04

*Standard Gold Flash.