

DETAILS

| | |
|------------------------|--------------------------|
| Product Number | C14530_FLORENCE-1R-Z2T25 |
| Family | Florence |
| Type | Lens |
| Color | clear |
| Diameter | 19,5 x 286 mm |
| Height | 6,4 mm |
| Style | rectang |
| Optic Material | PMMA |
| Holder Material | |
| Fastening | |
| Status | production ready |
| ROHS Compliant | Yes |
| Date Updated | 20/05/2015 |

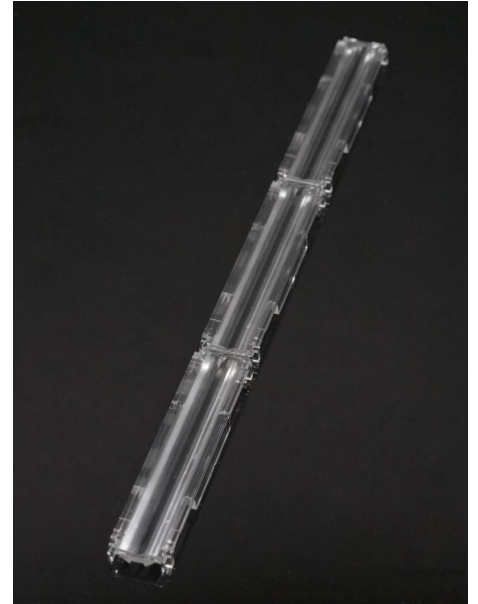

OPTICAL PROPERTIES

| LED | Viewing Angle | Light Beam | Efficiency | cd/lm | Connector |
|--|-----------------|------------|------------|-------|-----------|
| L0-280024-xxx-C0800-L267 | asymmetric deg | Asymmetric | 87 % | 0.420 | - |
| XH-B/G | Asymmetric deg | Asymmetric | 87 % | 0.410 | - |
| LG 5630 | sim: Asymmetric | Asymmetric | sim: 86 % | - | - |
| LUXEON 3535L | asymmetric deg | Asymmetric | 90 % | 0.470 | - |
| LUXEON 3030 2D | Asymmetric deg | Asymmetric | 87 % | 0.460 | - |
| LUXEON 3014 | Asymmetric deg | Asymmetric | 91 % | 0.610 | - |
| LUXEON 3020 | Asymmetric deg | Asymmetric | 91 % | 0.610 | - |
| MP-2016 | Asymmetric deg | Asymmetric | 88 % | 0.590 | - |
| NF2x757D | Asymmetric deg | Asymmetric | 87 % | 0.430 | - |
| NF2x757G | asymmetric deg | Asymmetric | 87 % | 0.440 | - |
| Duris S5 (2 chip) | Asymmetric deg | Asymmetric | 87 % | 0.430 | - |
| Fortimo LED Line 1ft 1100lm xx0 1R xV2 | Asymmetric deg | Asymmetric | 92 % | 0.490 | - |
| LM302A | asymmetric deg | Asymmetric | 88 % | 0.480 | - |
| LT-S282N | Asymmetric deg | Asymmetric | 90 % | 0.470 | - |
| LM301A | Asymmetric deg | Asymmetric | 88 % | 0.520 | - |
| LM561C | asymmetric deg | Asymmetric | 90 % | 0.520 | - |
| SEOUL 3030 | asymmetric deg | Asymmetric | 88 % | 0.460 | - |
| CALGD0414-M8W1 | asymmetric deg | Asymmetric | 88 % | 0.460 | - |
| CALGD0814-M17W1 | asymmetric deg | Asymmetric | 88 % | 0.460 | - |

H G F E D C B A

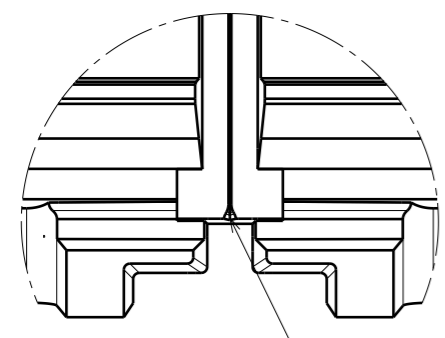
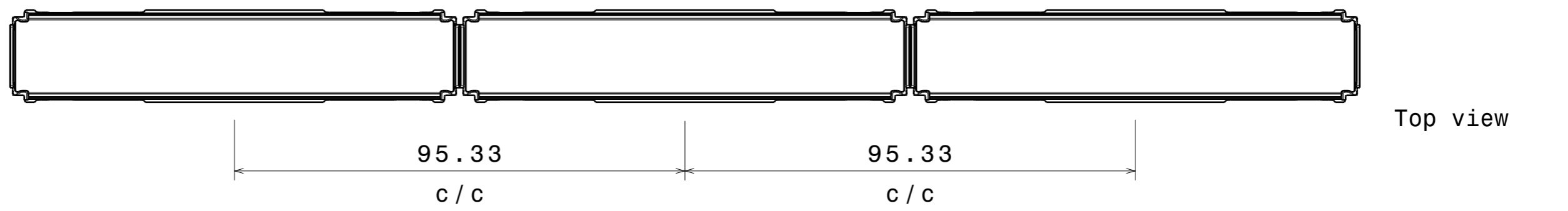
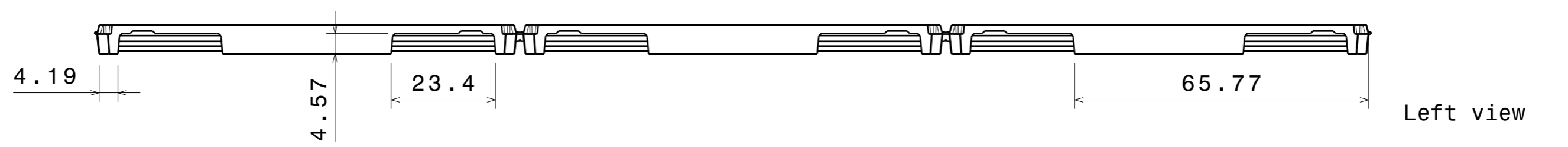
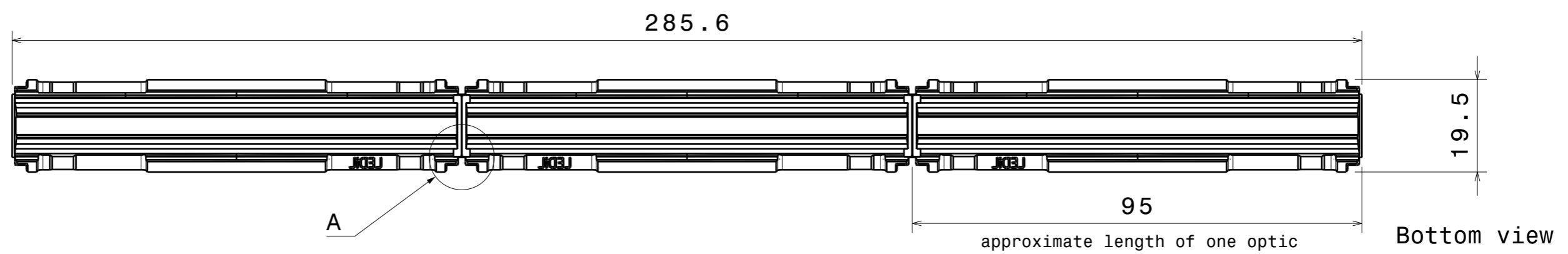

Detail A
Scale: 4:1

Snapping point *

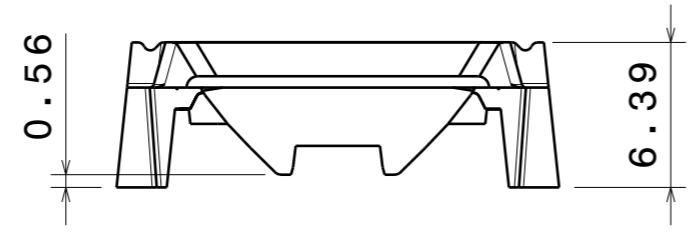

Front view
Scale: 3:1

* Optics can be snapped along this line and used also as single parts.

Tolerances if not otherwise shown
According to DIN ISO 2768-1
Linear measures:
Up to 30mm class M, otherwise class C
According to DIN ISO 2768-2
Form and position: class L

THIRD ANGLE PROJECTION:

This drawing is the property of LEDiL Oy. It may not be reproduced, copied or communicated without a written agreement with LEDiL Oy.

| INDEX | PART NO | DESCRIPTION | MATERIAL | COLOUR |
|---|-------------|---|----------|-----------|
| 1 | C14530 | FLORENCE - 1R - Z2T25 | PMMA | clear |
| | | LediL Oy Salorankatu 10 FIN 24240 SALO Finland | | |
| DRAWING TITLE C14530_FLORENCE - 1R - Z2T25 | | | | |
| SIZE | PART NUMBER | | | |
| A3 | C14530 | | | |
| SCALE | 1:1 | WEIGHT | 21,58 g | SHEET 1/1 |

H G B A

Luminaire: Ledil C14530_FLORENCE-1R-Z2T25_(CeZos)

Lamps: 1 x CeZos_(L0-280024-xxx-C0800-L267)_1346.29lm@250mA_CCT=3000K_P=8.5017W_I=0.25A

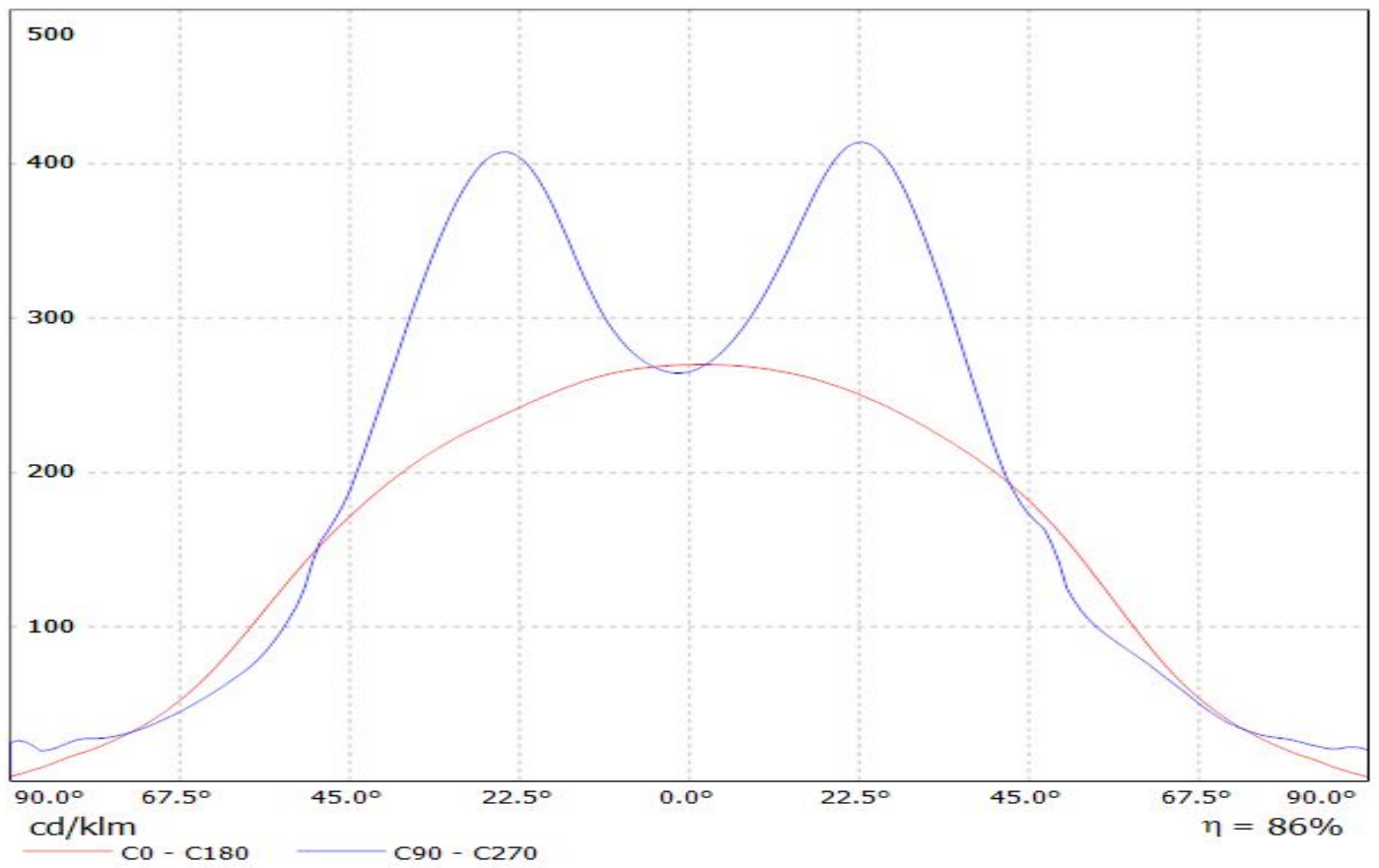

Ledil C14530_FLORENCE-1R-Z2T25_(XH-B) / LDC (Linear)

Luminaire: Ledil C14530_FLORENCE-1R-Z2T25_(XH-B)

Lamps: 1 x Cree_XH-B_x22_(XHBAWT-0-7B4-J20-0H-0001)_288.58lm@65mA_P=2.1W_I=0.065A

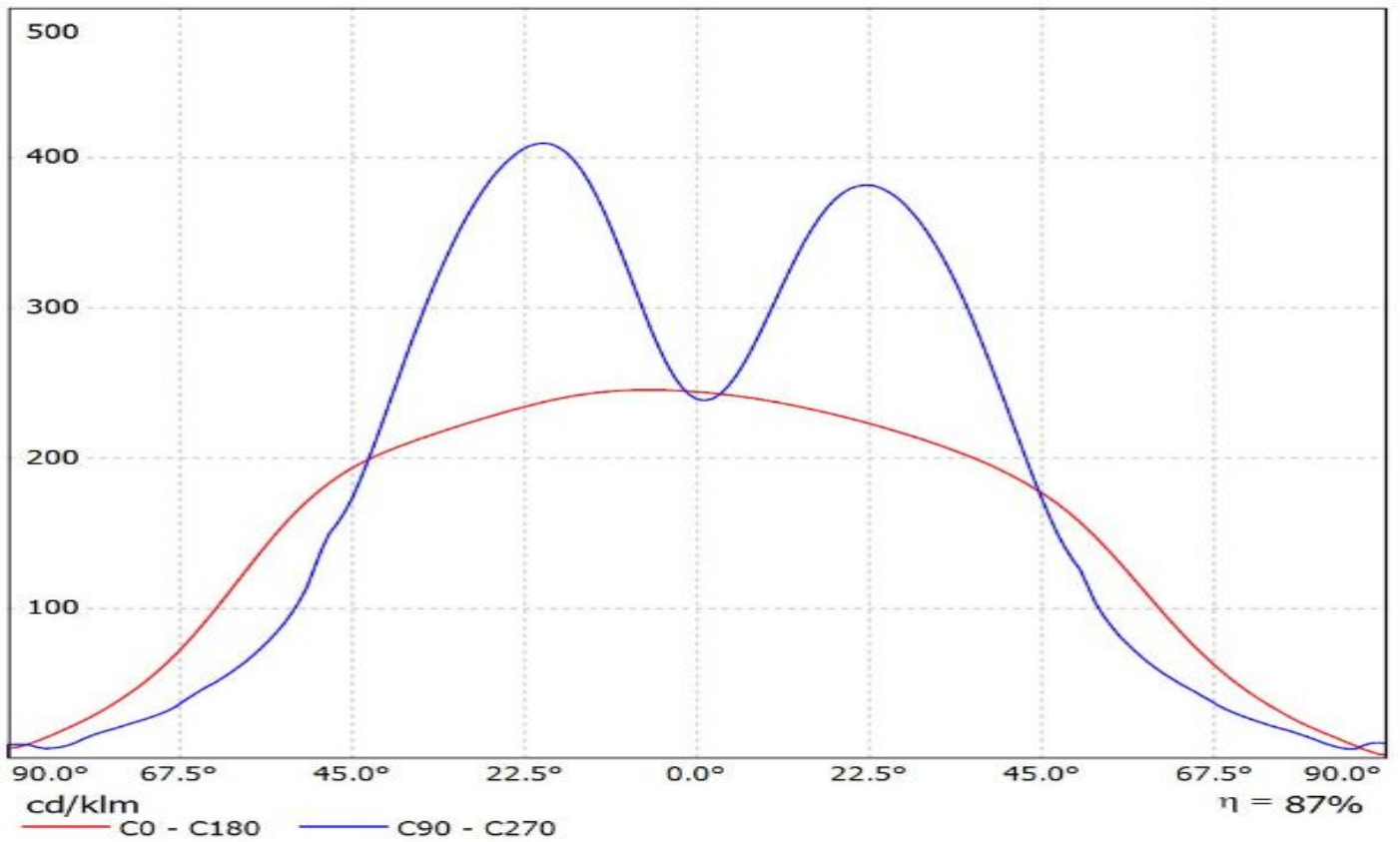

Luminaire: Ledil C14530_FLORENCE-1R-Z2T25_(3535L_x22)

Lamps: 1 x Luxeon_3535L_x22_(MXA8-PW50)_507.681lm@100mA_P=2.9953W_I=0.100mA

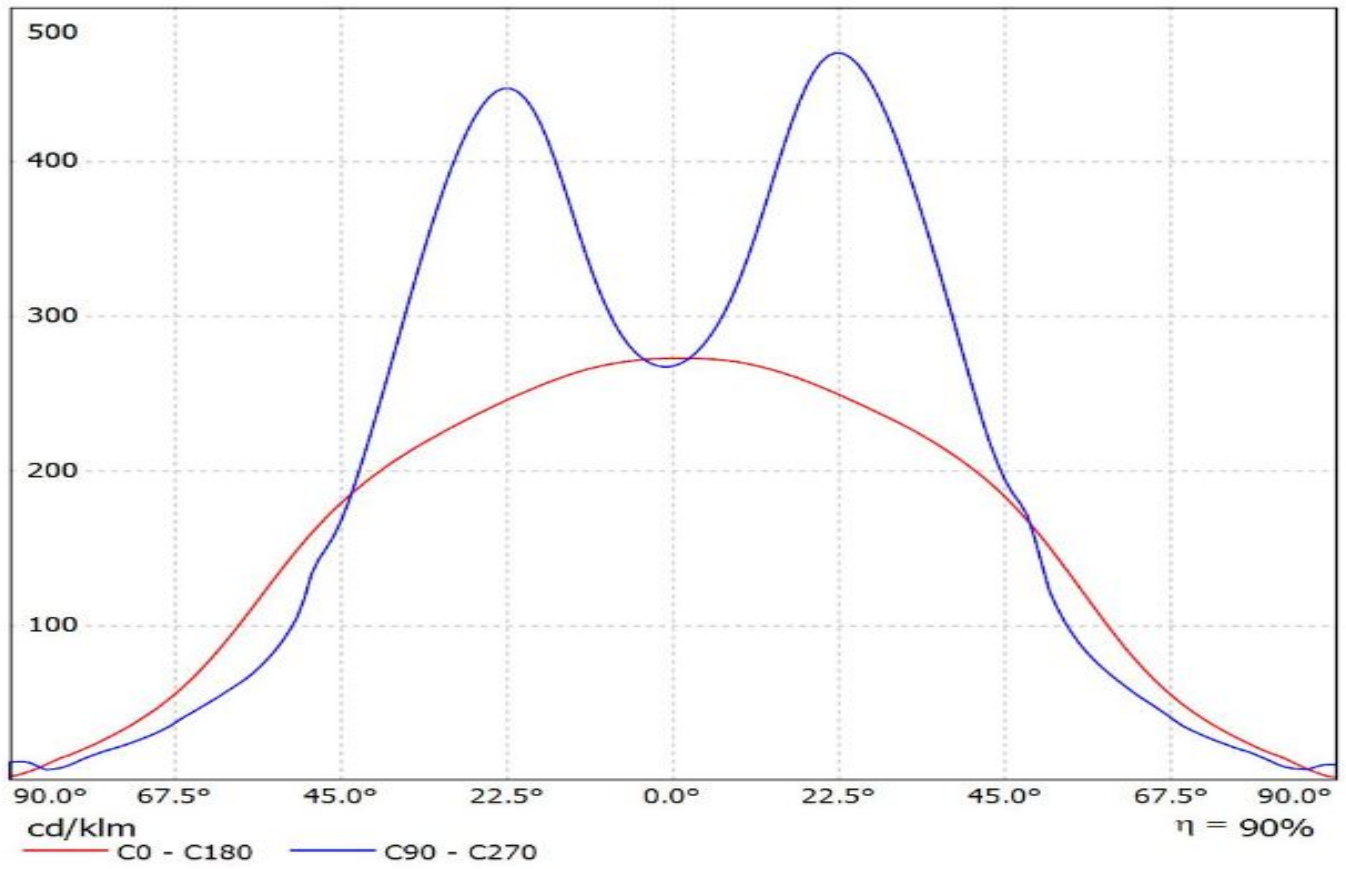

Ledil C14530_FLORENCE-1R-Z2T25_(Luxeon_3030_2D) / LDC (Linear)

Luminaire: Ledil C14530_FLORENCE-1R-Z2T25_(Luxeon_3030_2D)

Lamps: 1 x Luxeon_3030_2D_x22_(L130-4080003000W21)

_1601.44lm@200mA_CCT=4000K_P=12.8W_I=0.2A

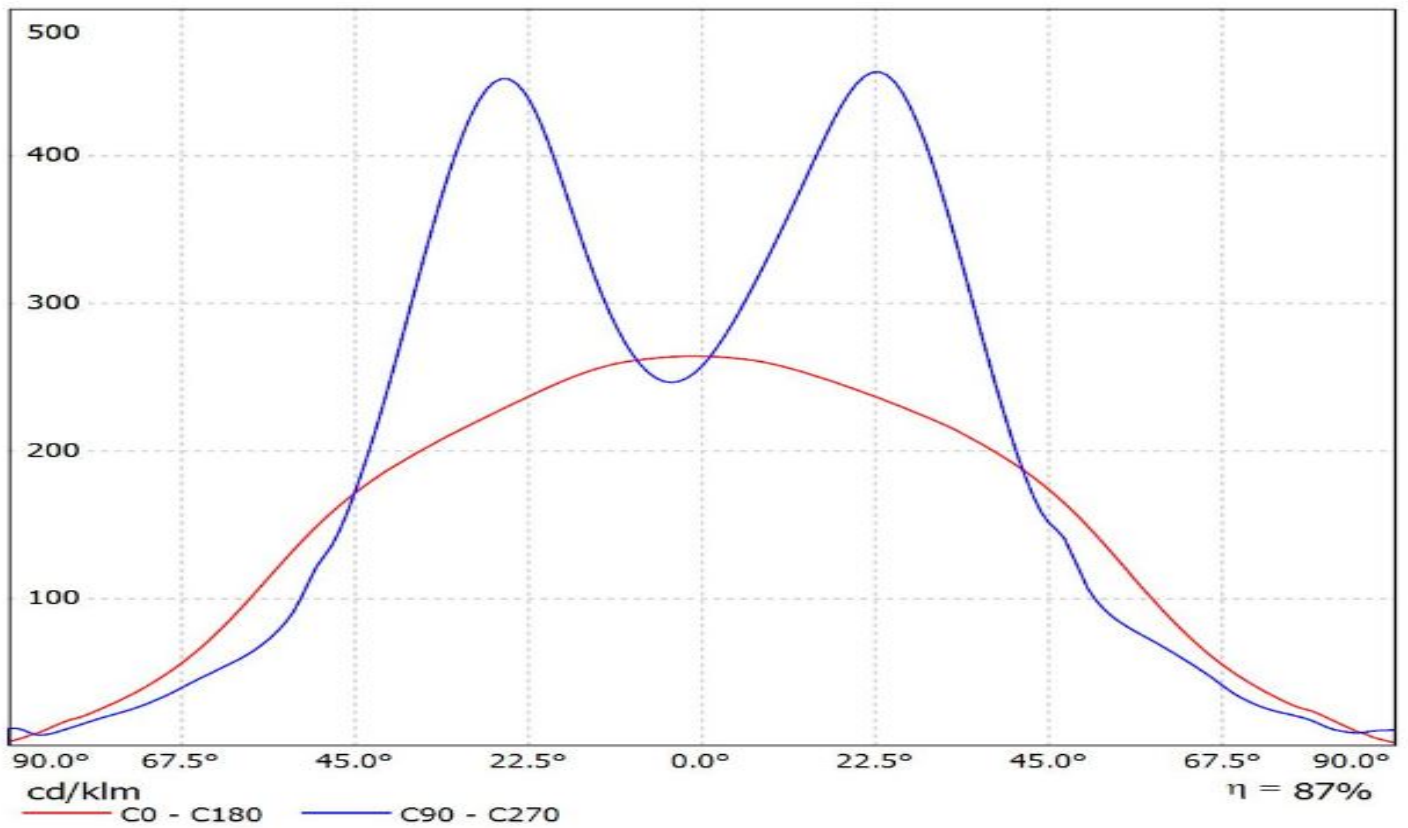

Luminaire: Ledil C14530_FLORENCE-1R-Z2T25_(3014_x22)

Lamps: 1 x Luxeon_3014_x22_(L130-5080)_283.511lm@60mA_P=1.9087W_I=0.060mA

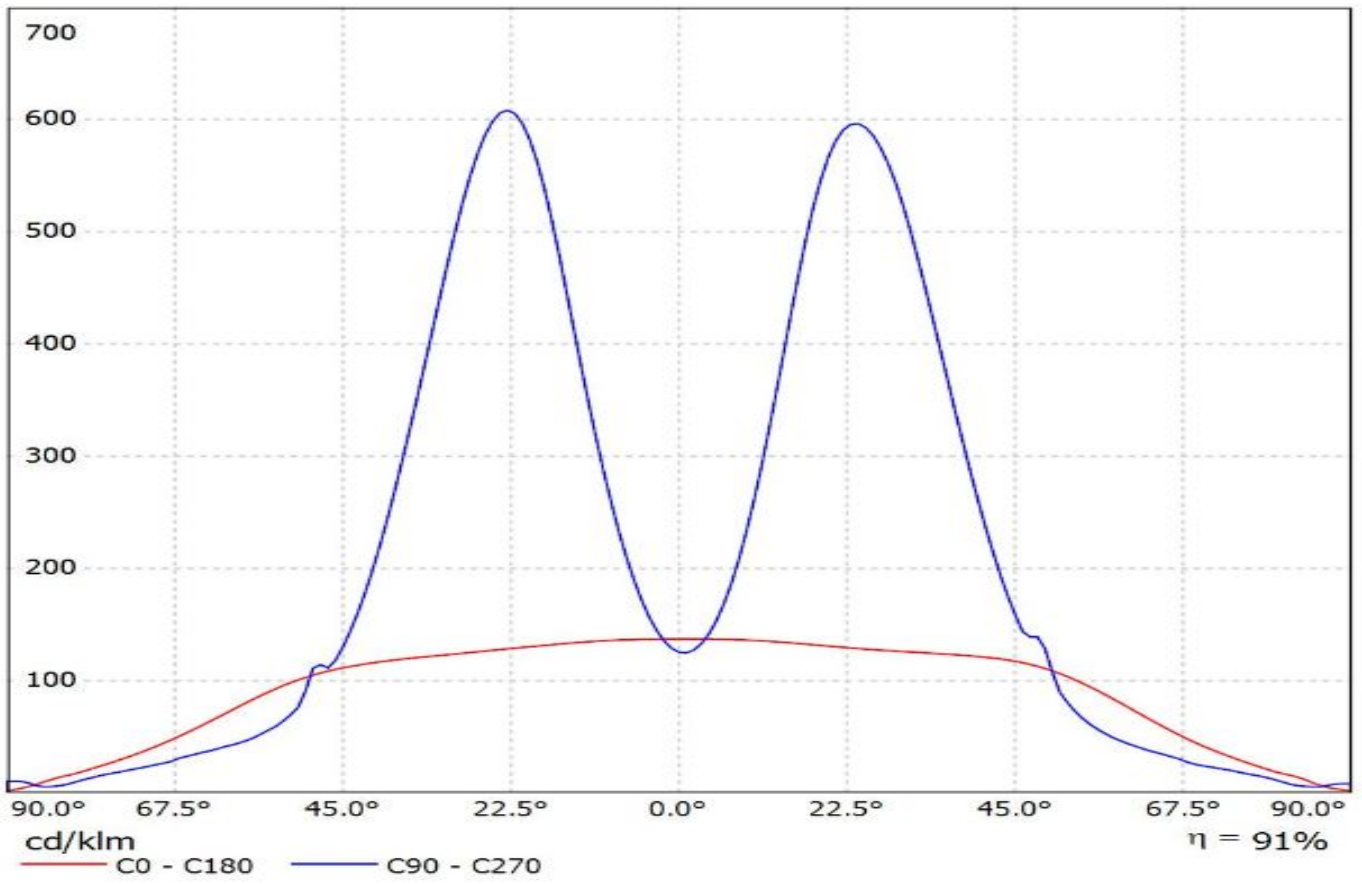

Luminaire: Ledil C14530_FLORENCE-1R-Z2T25_(3020)

Lamps: 1 x Luxeon_3020_x22_(L130-2780)_488.066lm@120mA_P=3.7731W_I=0.120mA

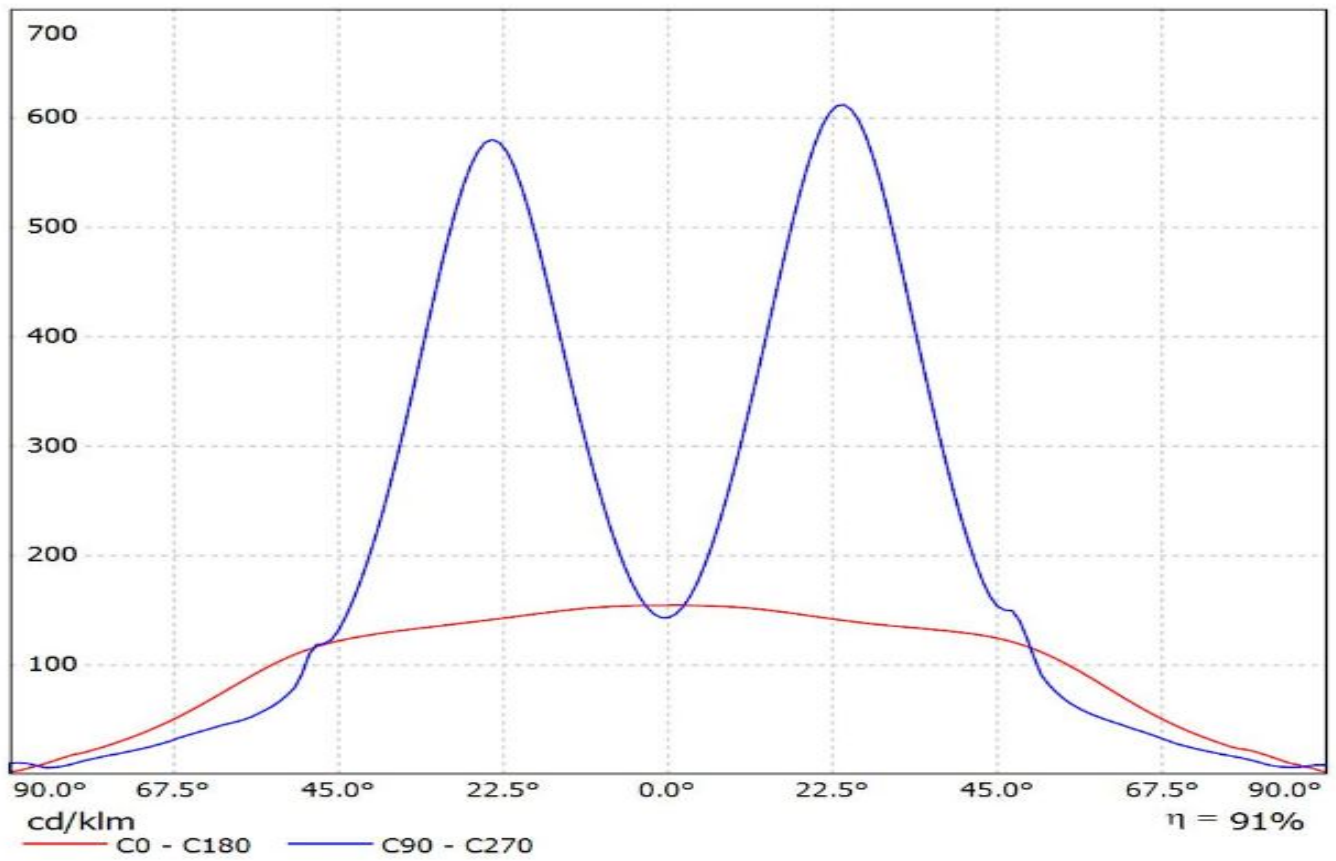

Ledil C14530_FLORENCE-1R-Z2T25_(Luminus_MP-2016) / LDC (Linear)

Luminaire: Ledil C14530_FLORENCE-1R-Z2T25_(Luminus_MP-2016)

Lamps: 1 x Luminus_MP-2016_1x22_(LUMMP-1100-30-80)_471.904lm@120mA_P=4W_I=0.12A

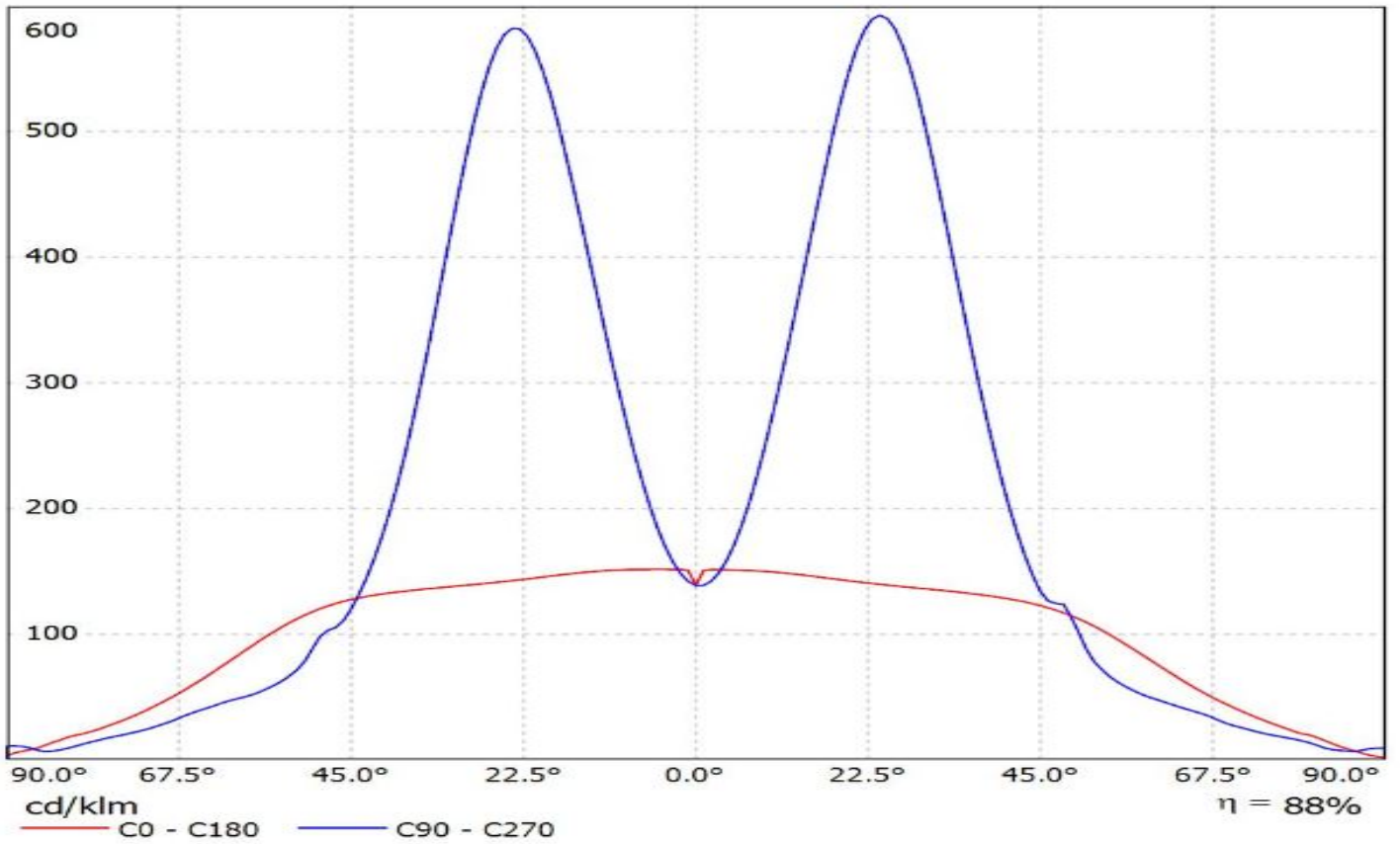

Ledil C14530_FLORENCE-1R-Z2T25_(NF2x757D) / LDC (Linear)

Luminaire: Ledil C14530_FLORENCE-1R-Z2T25_(NF2x757D)

Lamps: 1 x Nichia_NF2x757D_2chip_x22 (NF2W757DRT)_2050.61lm@200mA_P=12.95W_I=0.2A

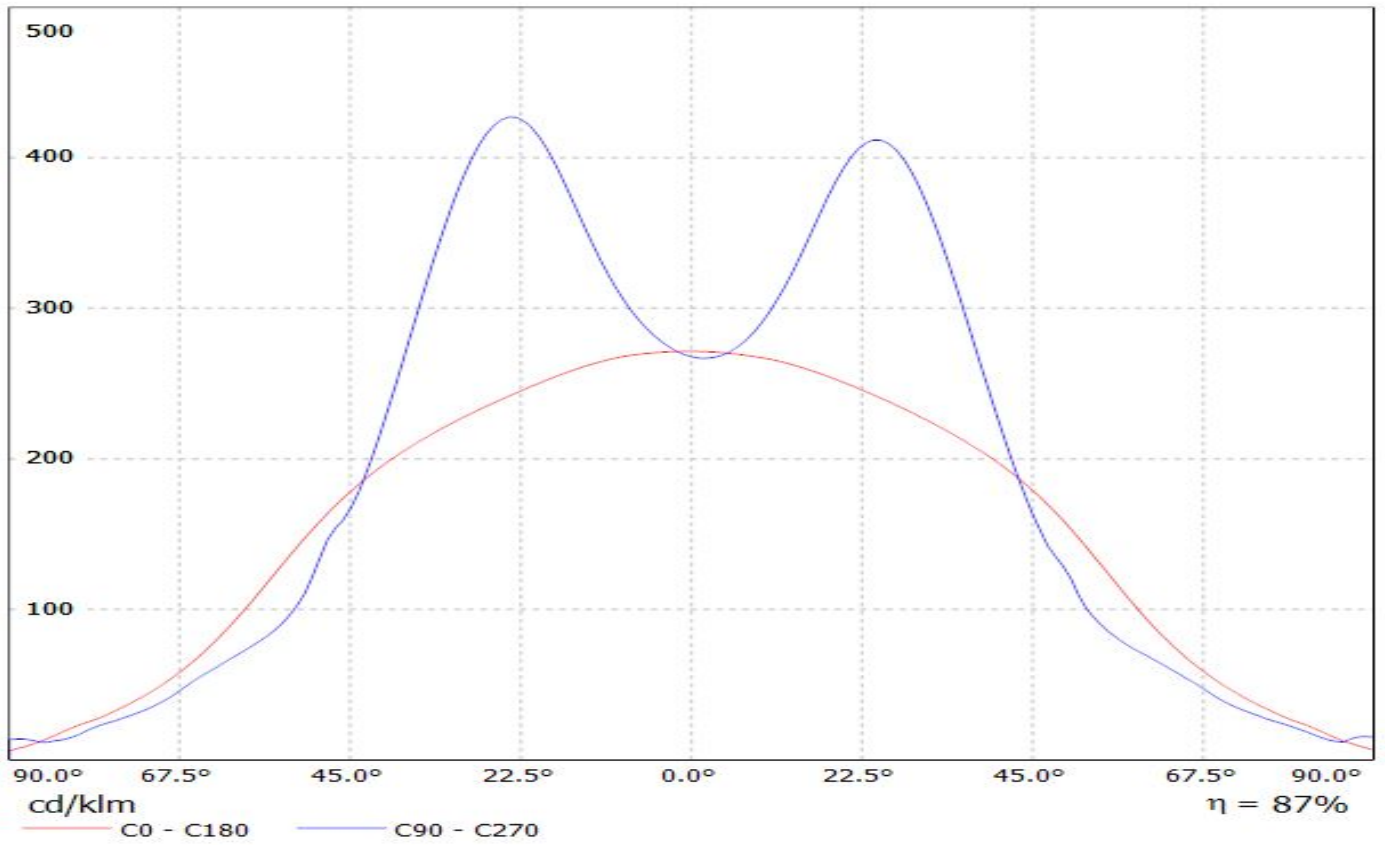

Luminaire: Ledil C14530_FLORENCE-1R-Z2T25_(NF2W757G)
Lamps: 1 x NF2W757G_377.885lm@65mA_CCT=?K_P=1.97W_I=0.065A

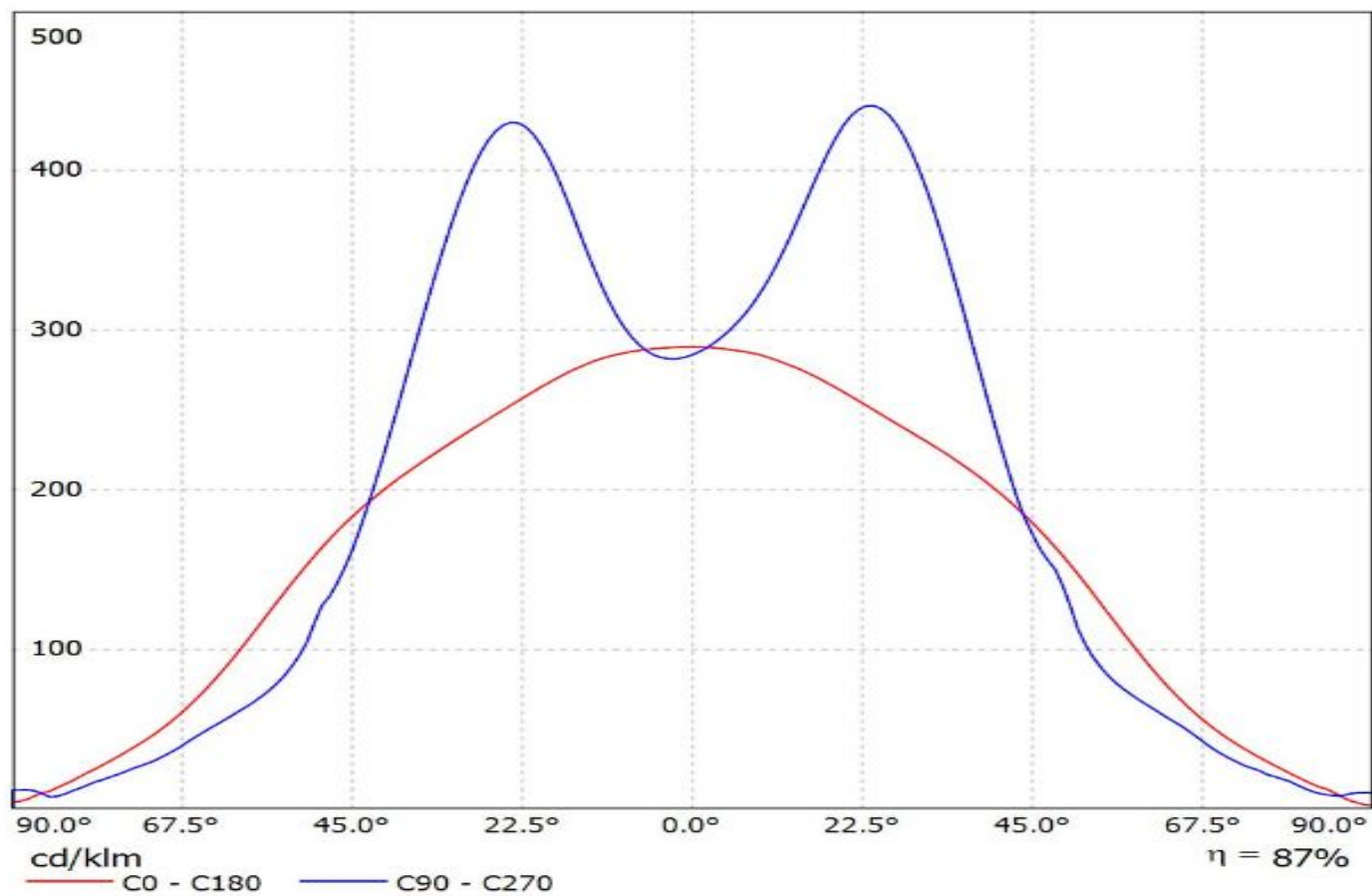

Ledil C14530_FLORENCE-1R-Z2T25_(Duris_S5) / LDC (Linear)

Luminaire: Ledil C14530_FLORENCE-1R-Z2T25_(Duris_S5)
Lamps: 1 x Osram_Duris_S5_x11_(GW_PSLRS1.EC-LQLS-5H7I-1)
_1016.86lm@100mA_P=8W_I=0.1000A

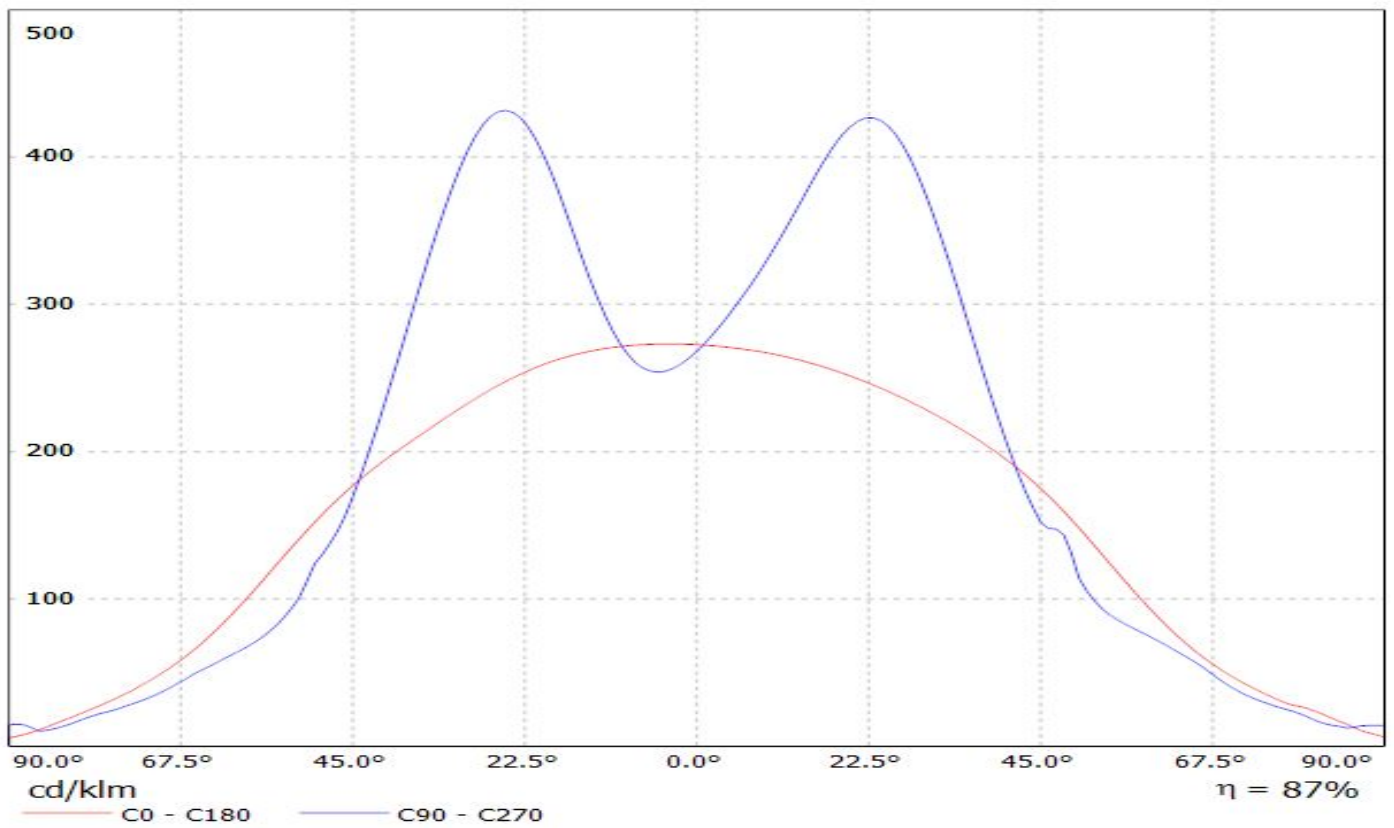

Luminaire: LEDiL Oy C14530_FLORENCE-1R-Z2T25_(Fortimo)

Lamps: 1 x Fortimo_LED_line_1ft_1100lm_840_1R_HV2_1063.26lm@250mA_P=8.02158W_I=0.2498A

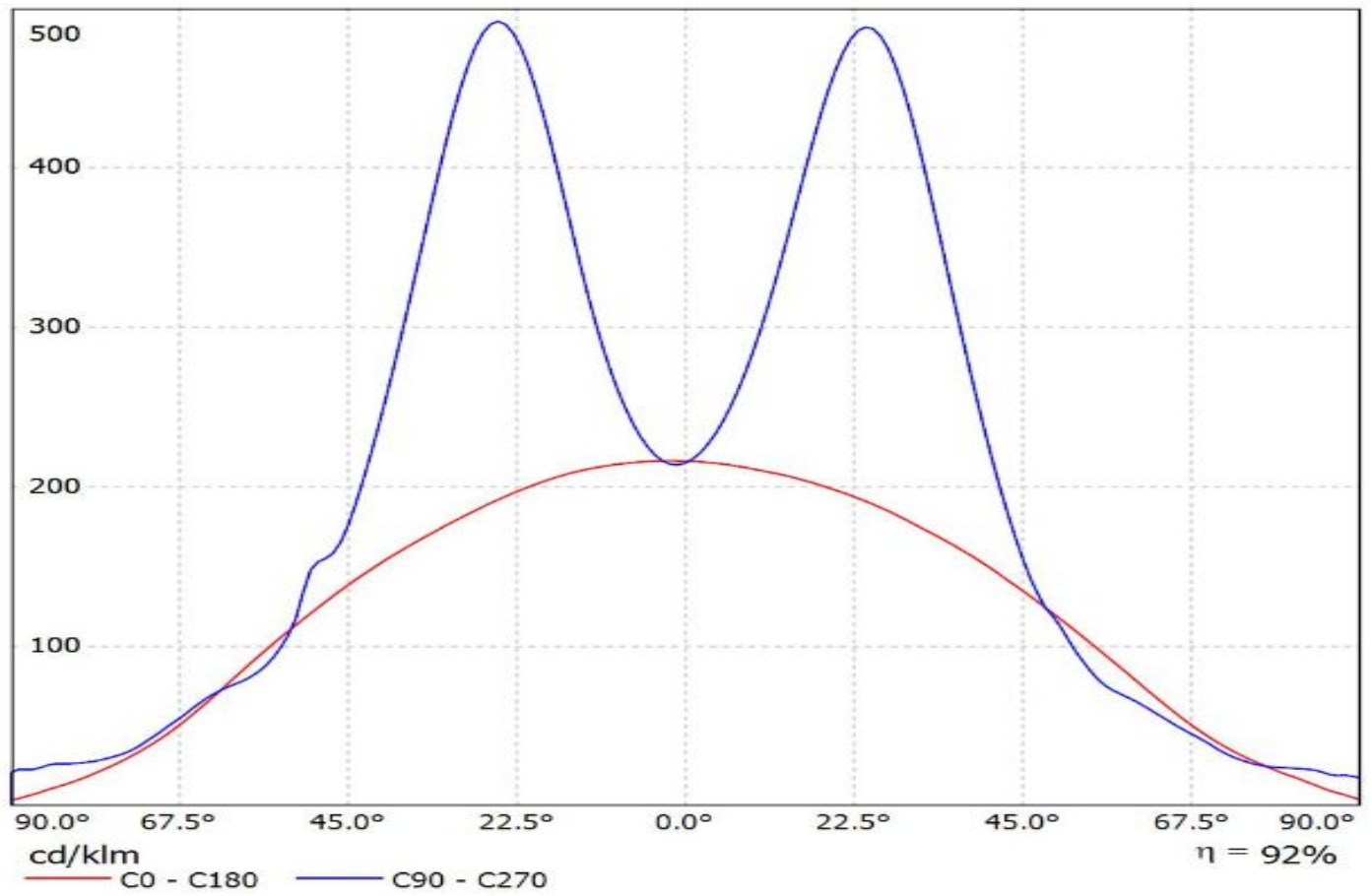

Luminaire: LEDiL Oy C14530_FLORENCE-1R-Z2T25_(LM302A)
Lamps: 1 x Samsung_LM302A_865.46lm@100mA_P=6.64694W_I=0.1001A

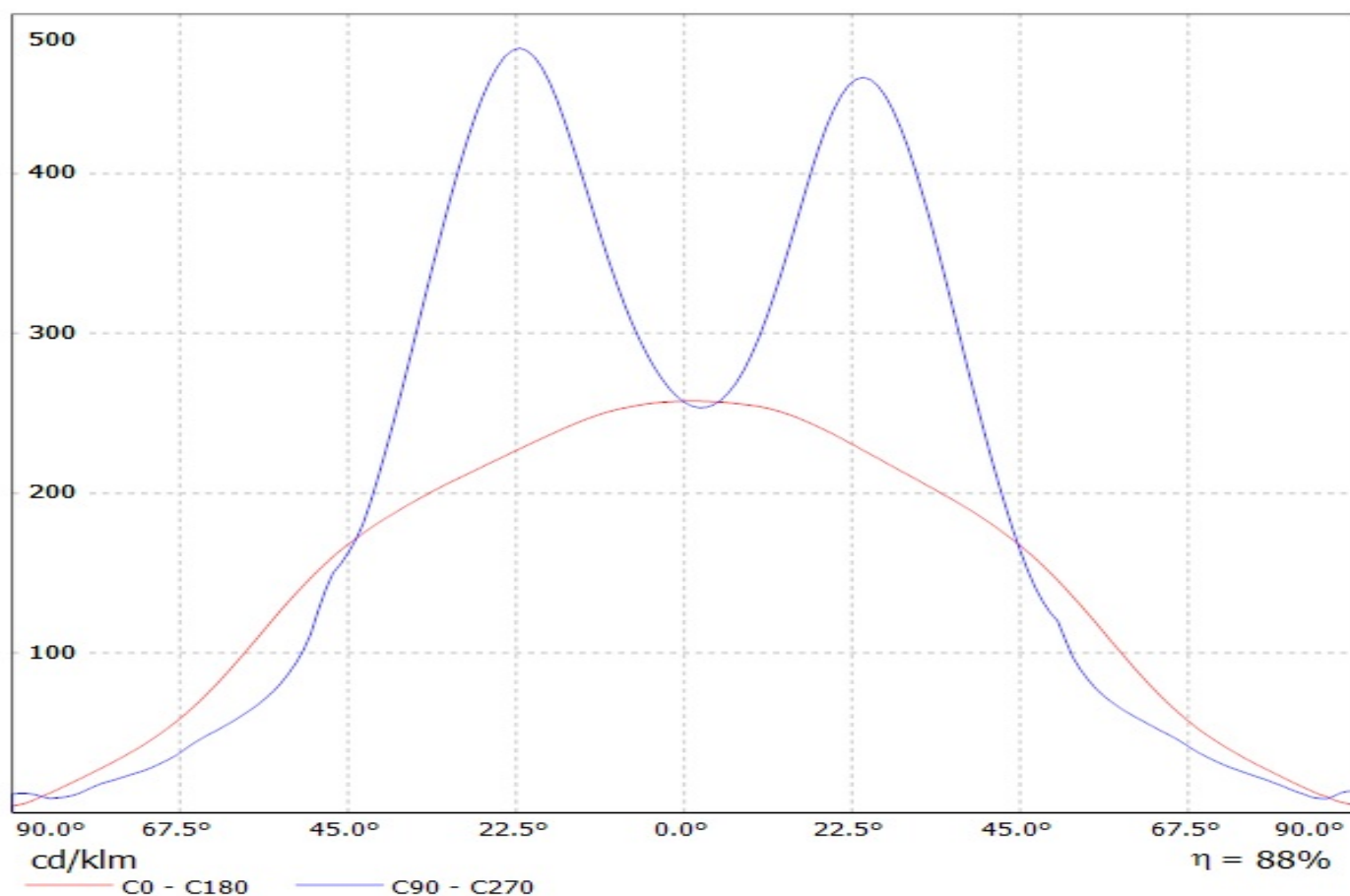

Luminaire: Ledil C14530_FLORENCE-1R-Z2T25_(LM301A)

Lamps: 1 x Samsung_LM301A_x11_(SPMWHT328FD5WAT0S0)_1107.77lm@250mA_P=8.1W_I=0.25A

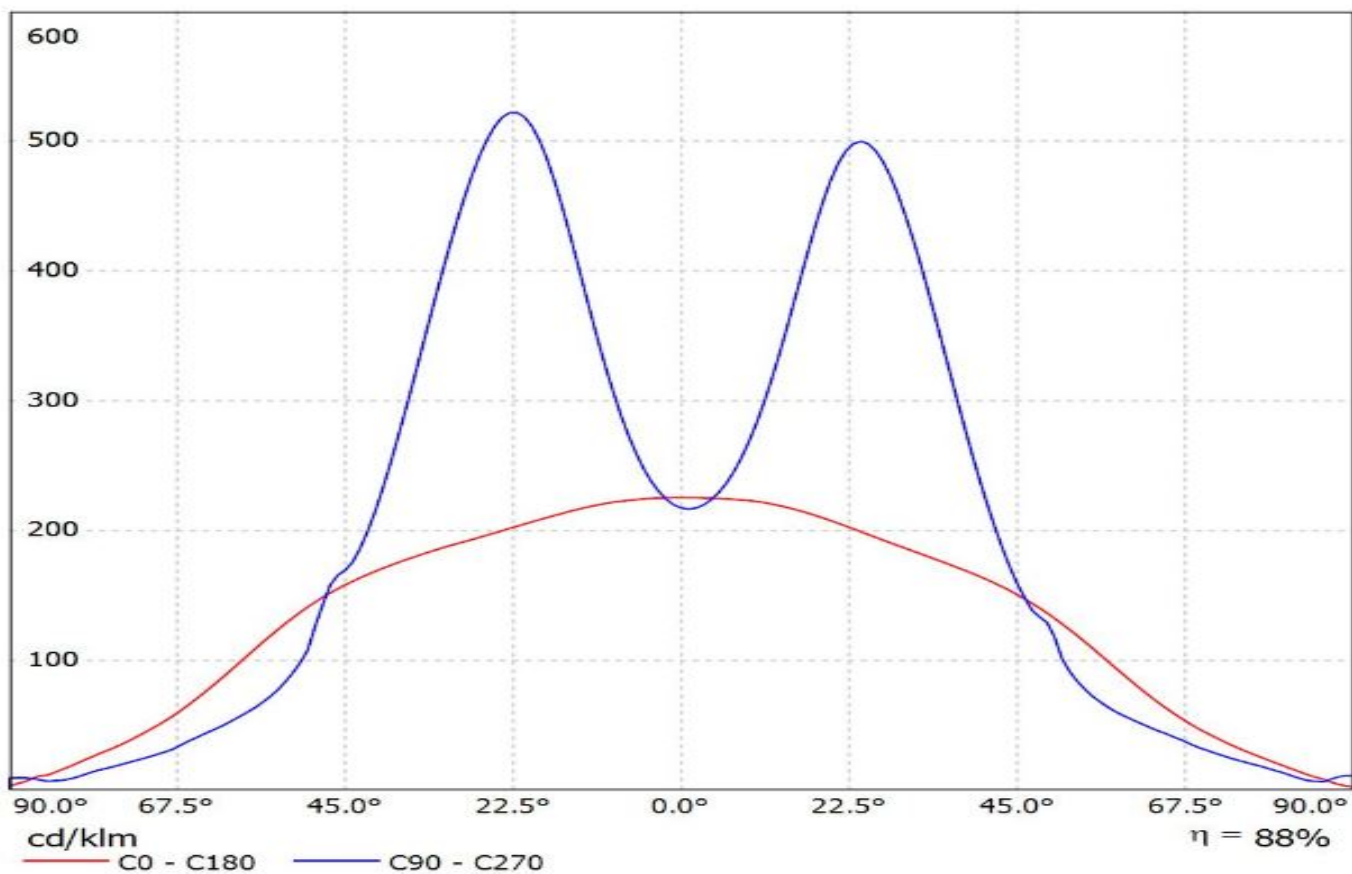

Luminaire: LEDiL Oy C14530_FLORENCE-1R-Z2T25_(LM561C)
Lamps: 1 x Samsung_LM561C_685.154lm@130mA_P=3.9367W_I=0.130A

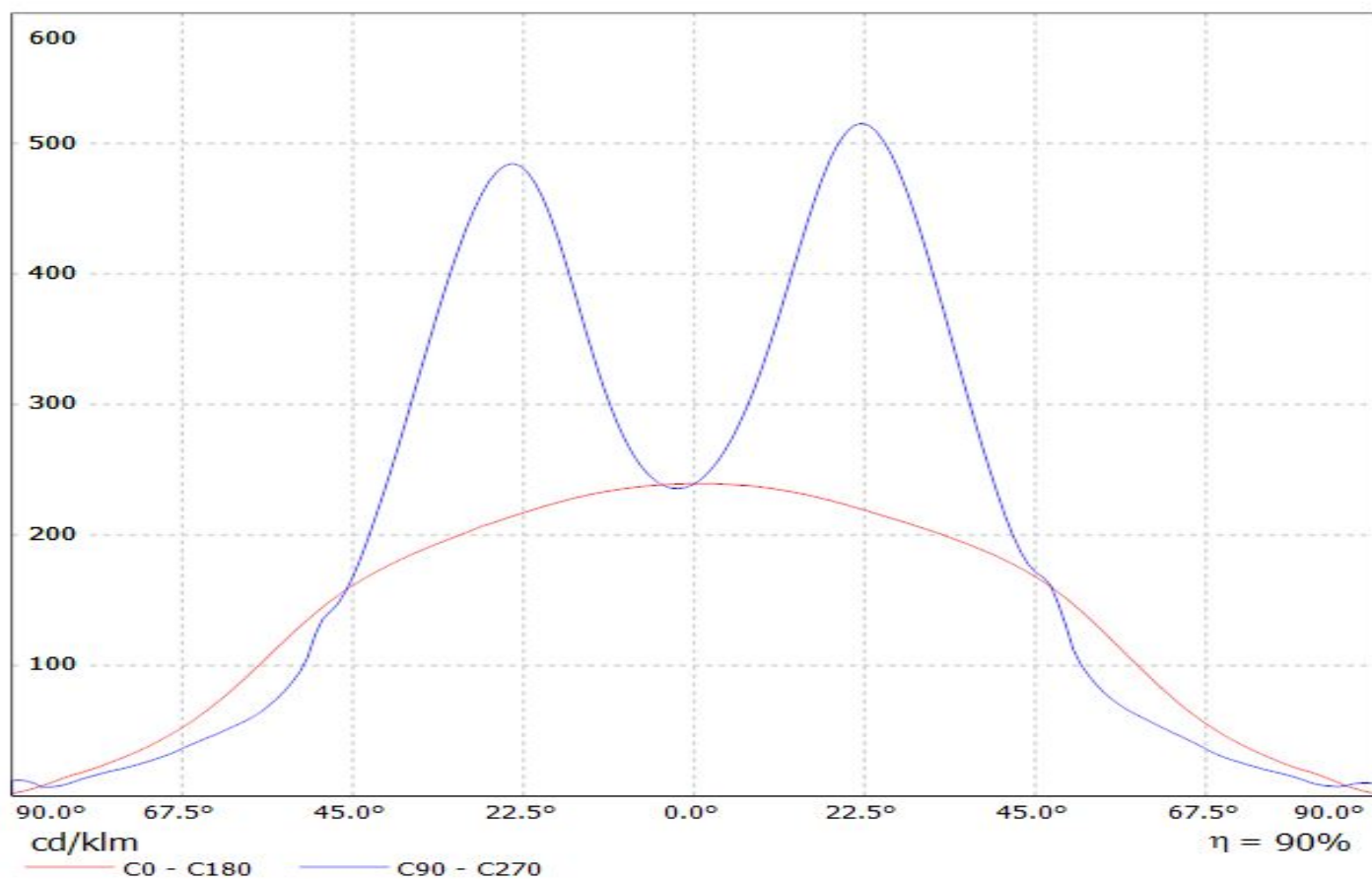

Ledil C14530_FLORENCE-1R-Z2T25_(Seoul_3030) / LDC (Linear)

Luminaire: Ledil C14530_FLORENCE-1R-Z2T25_(Seoul_3030)

Lamps: 1 x Seoul_3030_x11_(STW8C2SA)_785.296lm@100mA_P=6.5W_I=0.1A

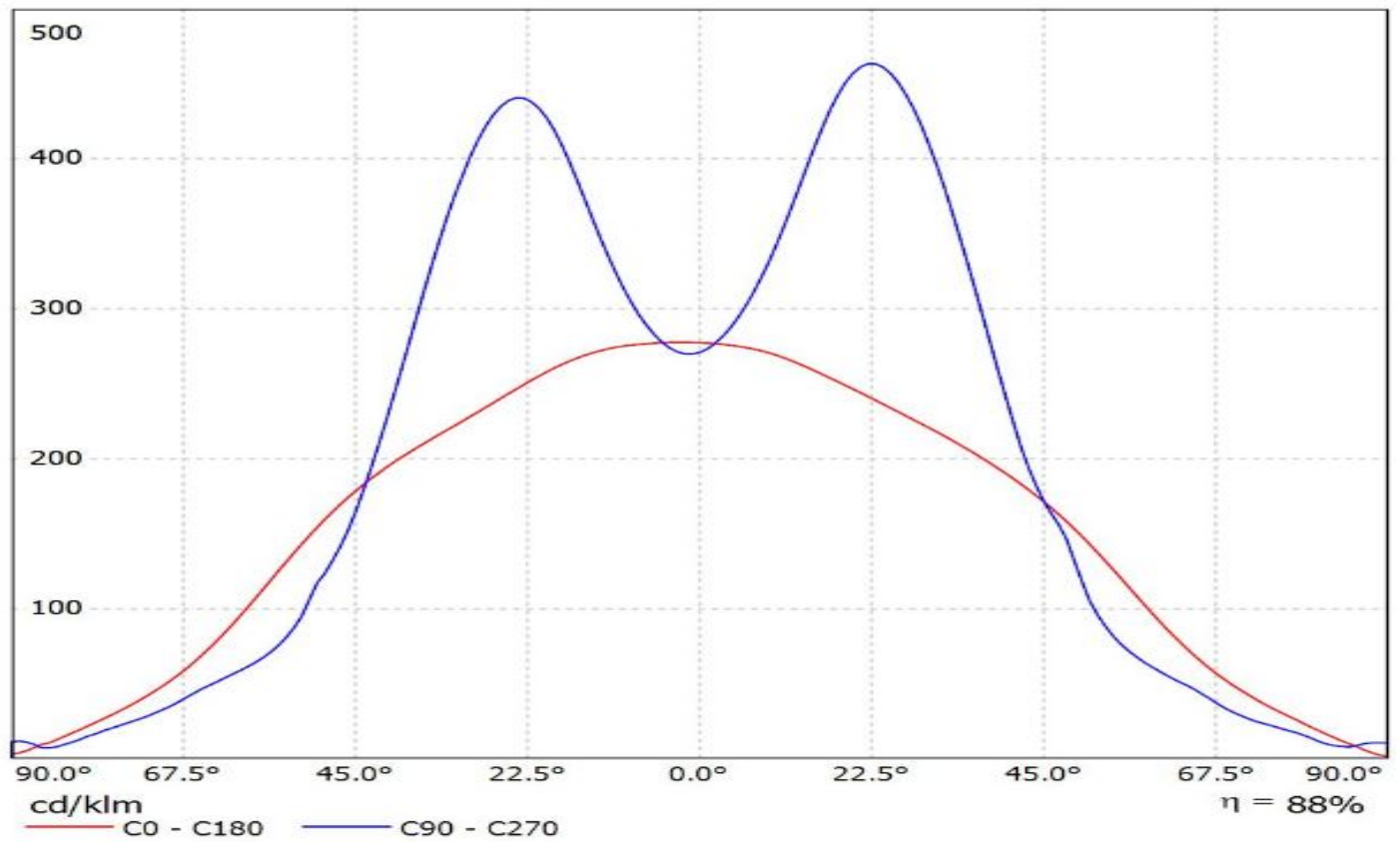

Luminaire: Ledil C14530_FLORENCE-1R-Z2T25_(CALGD0414-M8W1)
Lamps: 1 x Citizen_CALGD0414-M8W1_556.672lm@350mA_P=4.0291W_I=0.3499A

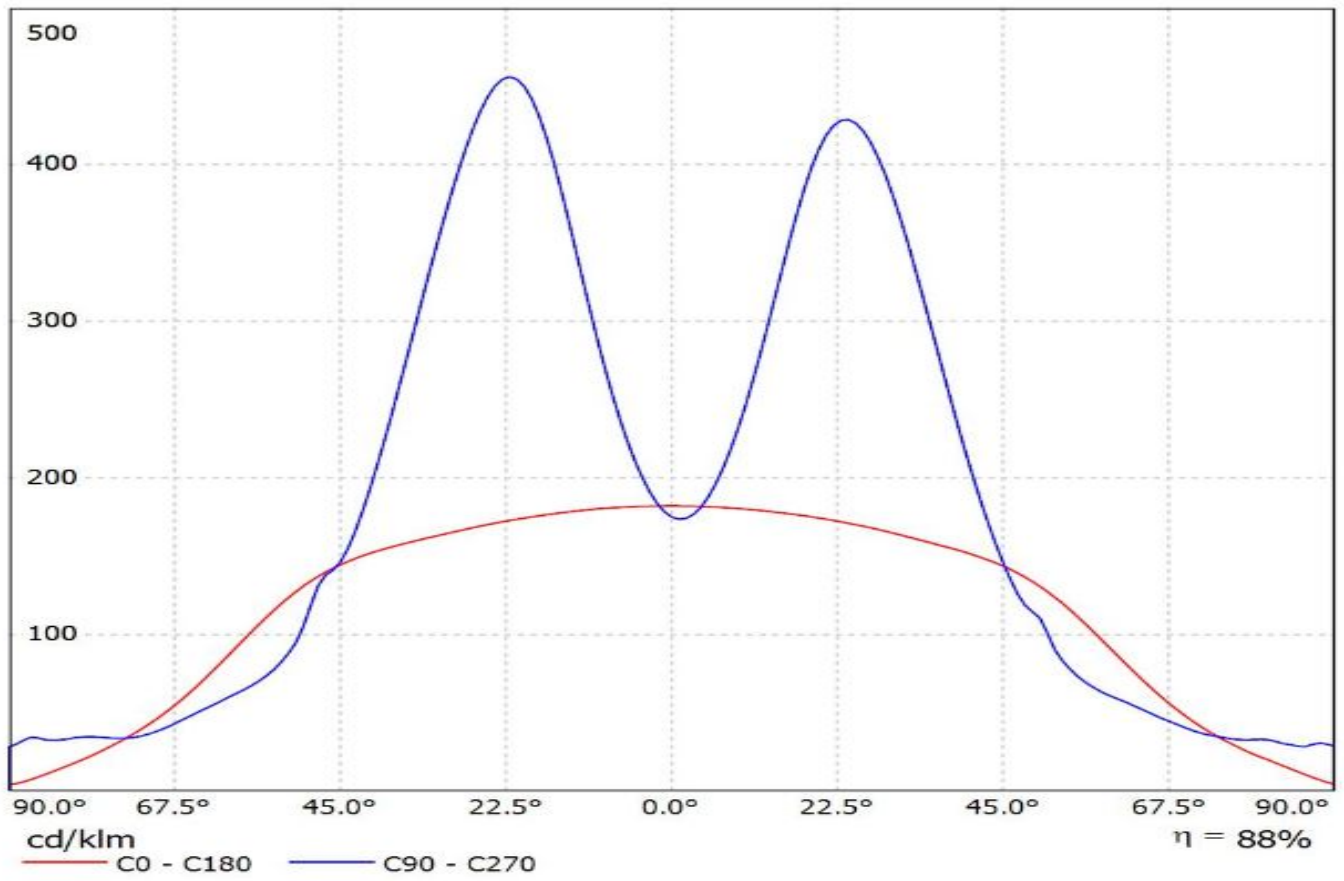

Luminaire: Ledil C14530_FLORENCE-1R-Z2T25_(CALGD0814-M17W1)

Lamps: 1 x Citizen_(CALGD0814-M17W1)_1098.26lm@350mA_P=7.96302W_I=0.3499A

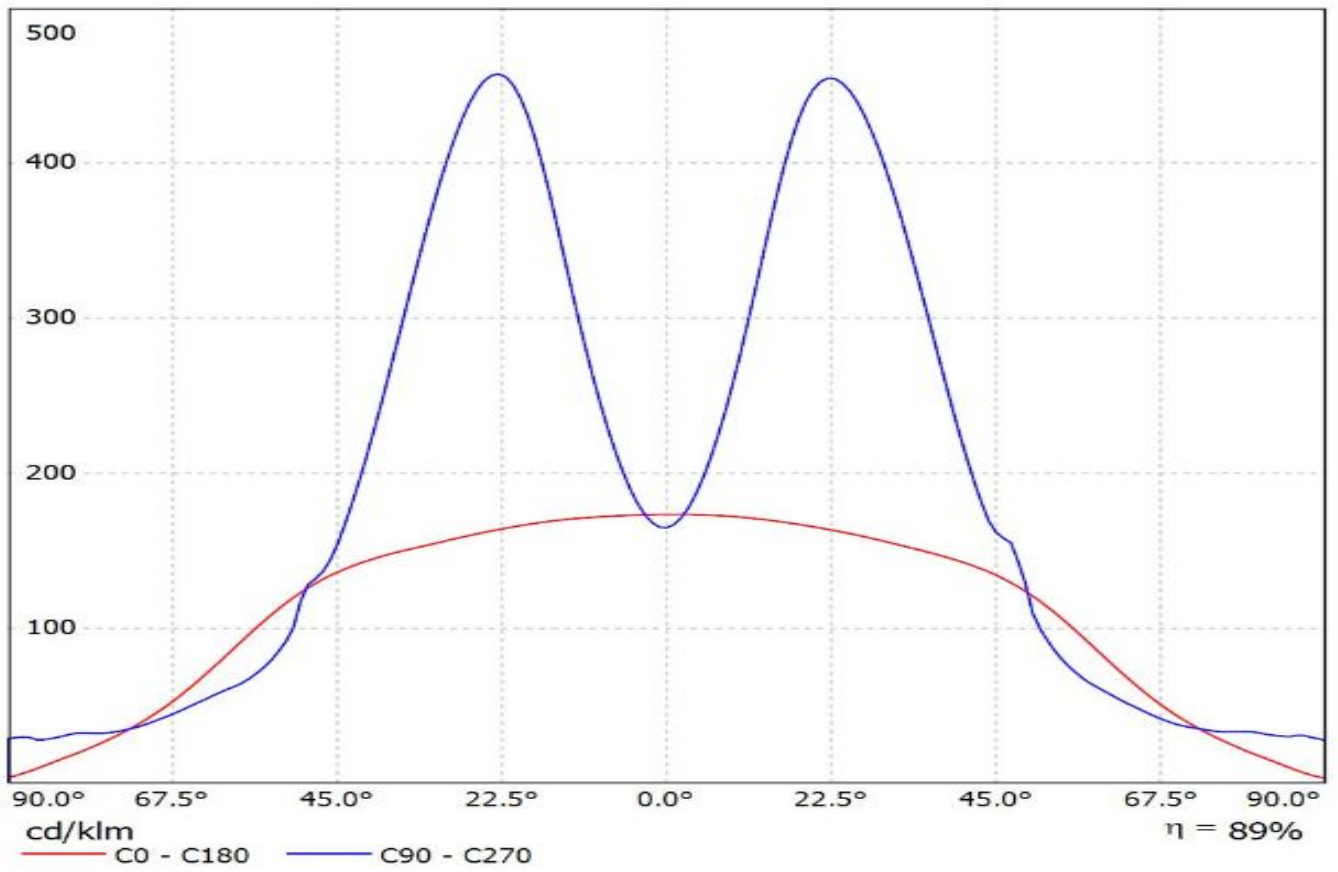

Luminaire: Ledil C14530_FLORENCE-1R-Z2T25_(CeZos)

Lamps: 1 x CeZos_(L0-280024-xxx-C0800-L267)_1346.29lm@250mA_CCT=3000K_P=8.5017W_I=0.25A

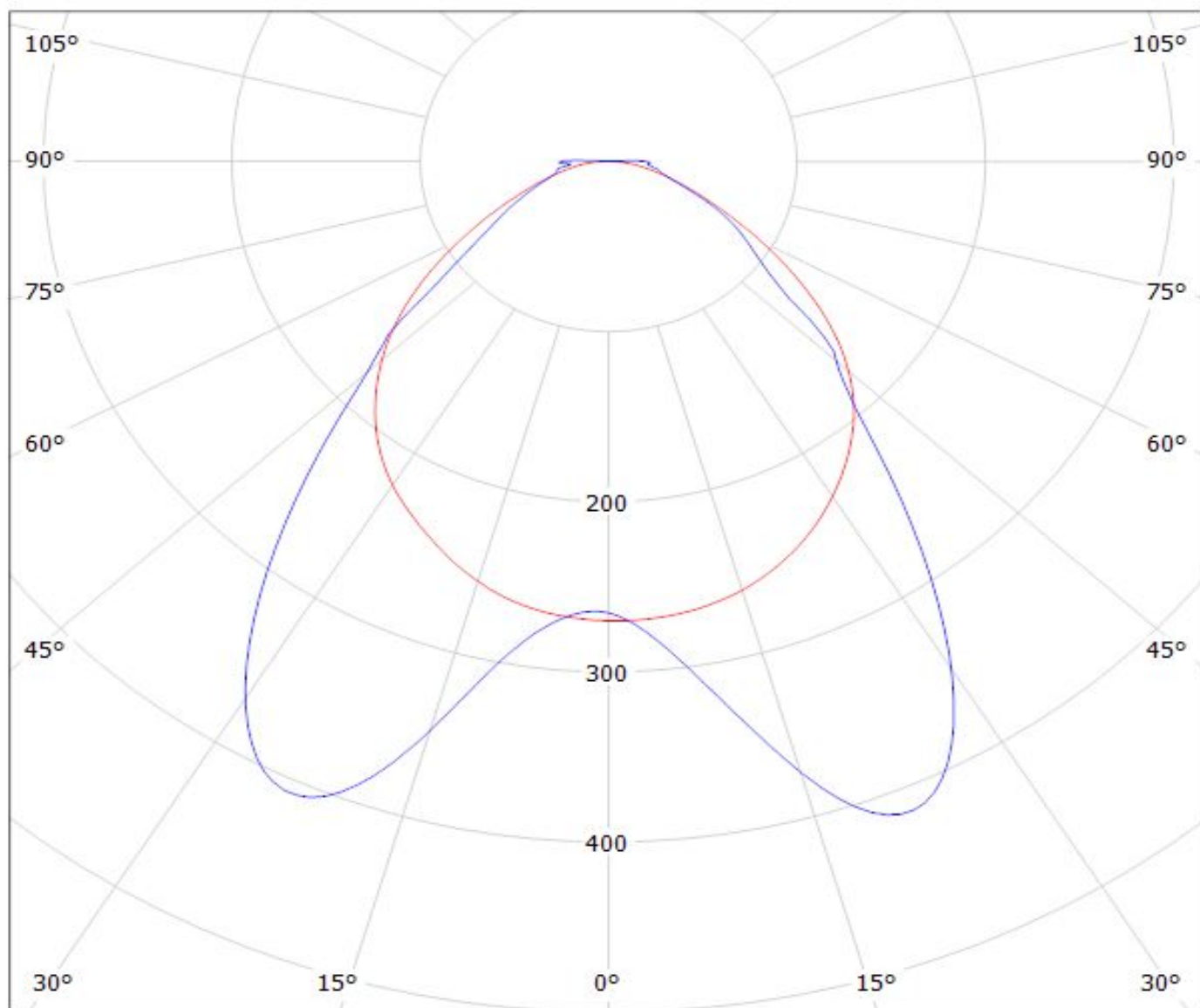

cd/klm

— C0 - C180

— C90 - C270

$\eta = 86\%$

Ledil C14530_FLORENCE-1R-Z2T25_(XH-B) / LDC (Polar)

Luminaire: Ledil C14530_FLORENCE-1R-Z2T25_(XH-B)

Lamps: 1 x Cree_XH-B_x22_(XHBAAWT-0-7B4-J20-0H-0001)_288.58lm@65mA_P=2.1W_I=0.065A

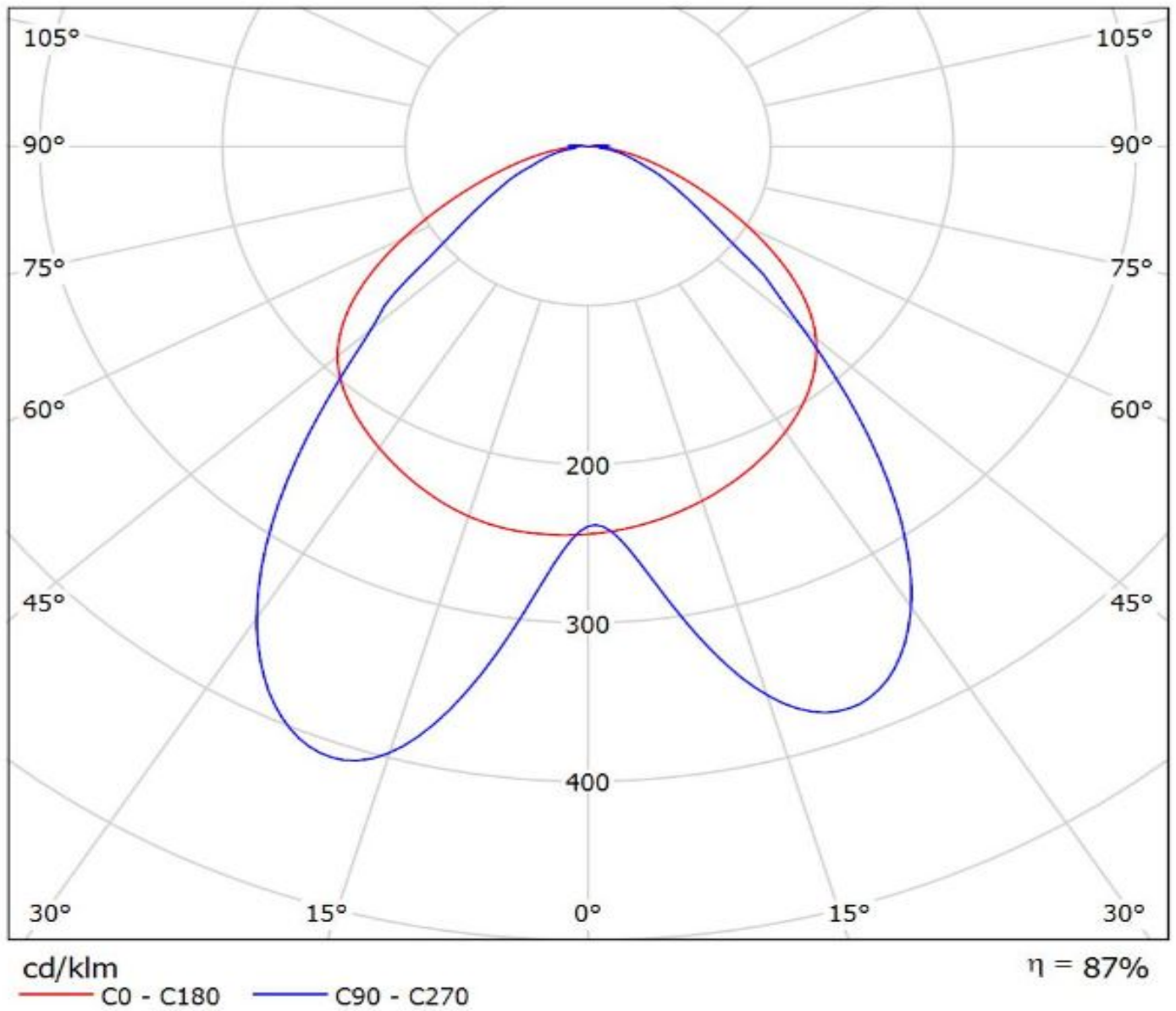

Luminaire: Ledil C14530_FLORENCE-1R-Z2T25_(3535L_x22)

Lamps: 1 x Luxeon_3535L_x22_(MXA8-PW50)_507.68lm@100mA_P=2.9953W_I=0.100mA

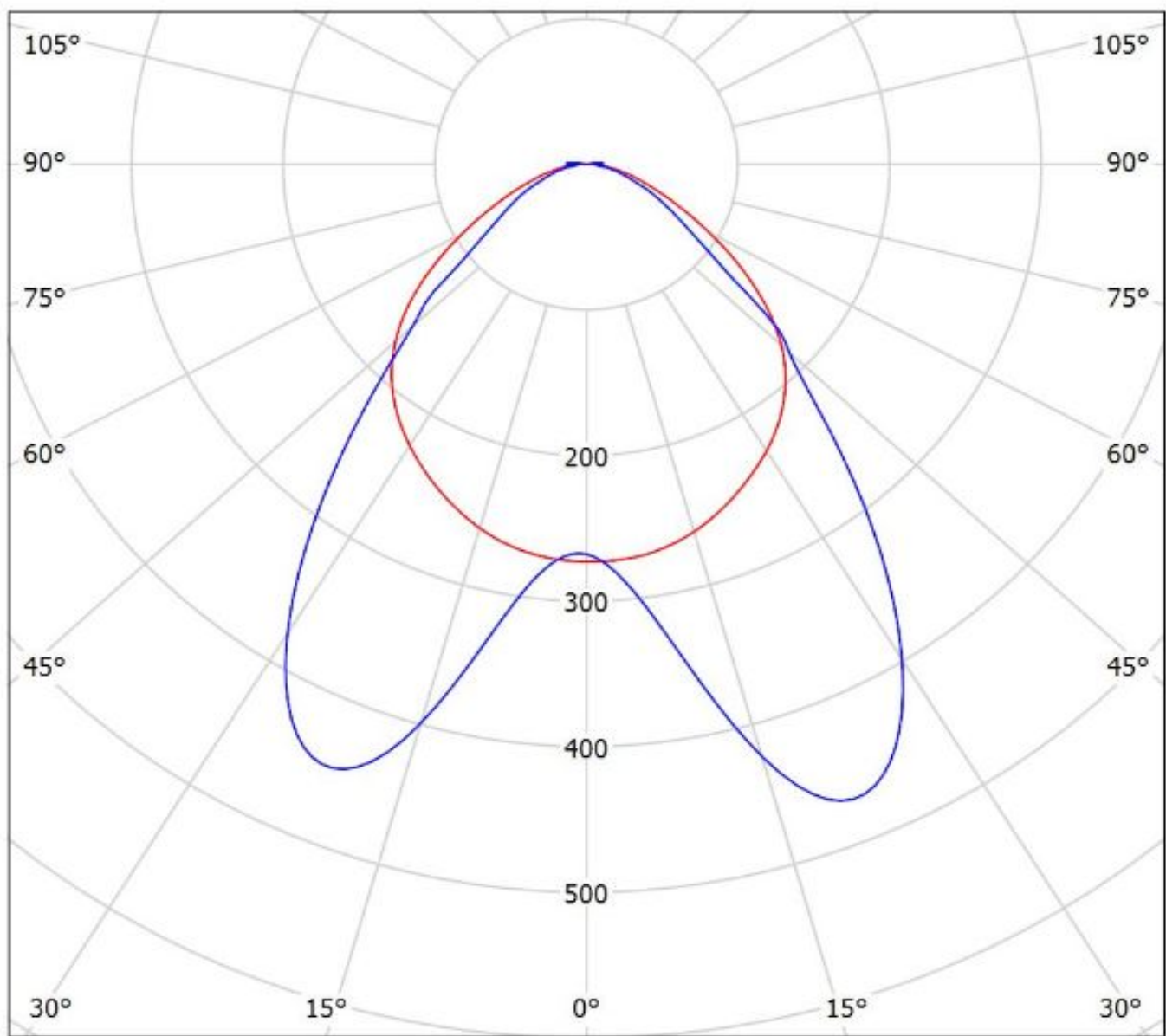

cd/klm

— C0 - C180 — C90 - C270

$\eta = 90\%$

Ledil C14530_FLORENCE-1R-Z2T25_(Luxeon_3030_2D) / LDC (Polar)

Luminaire: Ledil C14530_FLORENCE-1R-Z2T25_(Luxeon_3030_2D)
Lamps: 1 x Luxeon_3030_2D_x22_(L130-4080003000W21)
_1601.44lm@200mA_CCT=4000K_P=12.8W_I=0.2A

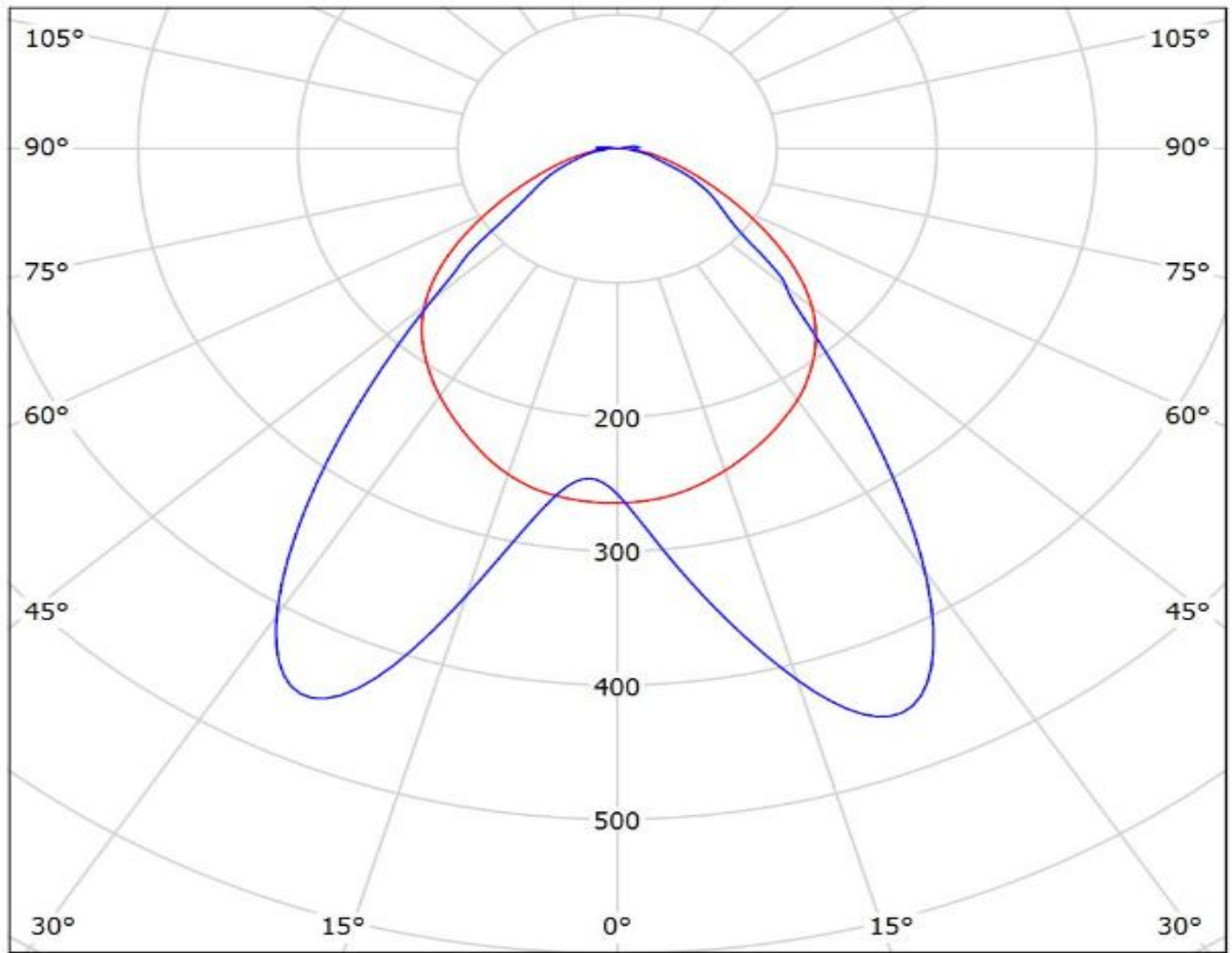

cd/klm

— C0 - C180 — C90 - C270

$\eta = 87\%$

Luminaire: Ledil C14530_FLORENCE-1R-Z2T25_(3014_x22)

Lamps: 1 x Luxeon_3014_x22_(L130-5080)_283.511lm@60mA_P=1.9087W_I=0.060mA

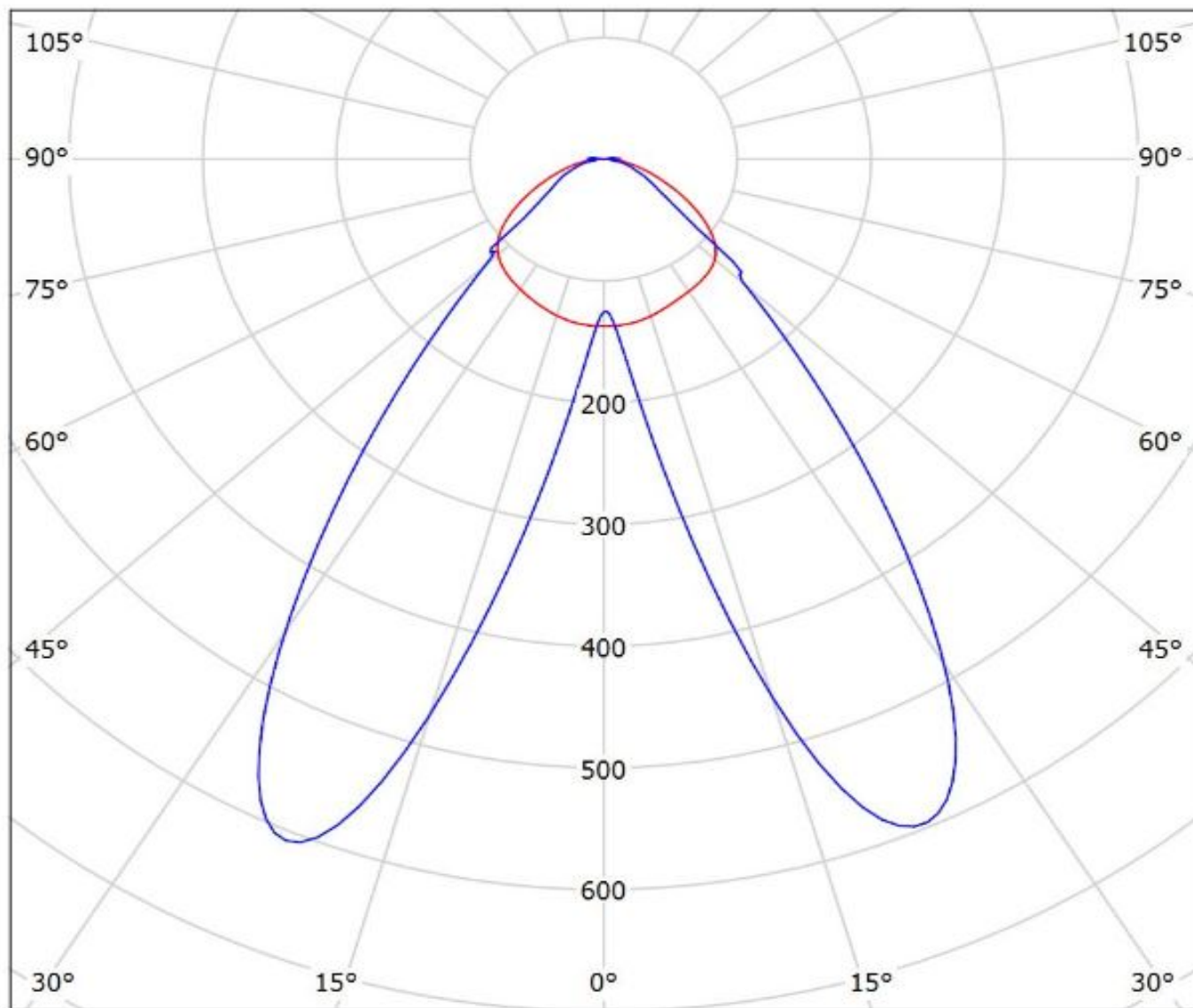

cd/klm

— C0 - C180 — C90 - C270

$\eta = 91\%$

Luminaire: Ledil C14530_FLORENCE-1R-Z2T25_(3020)

Lamps: 1 x Luxeon_3020_x22_(L130-2780)_488.066lm@120mA_P=3.7731W_I=0.120mA

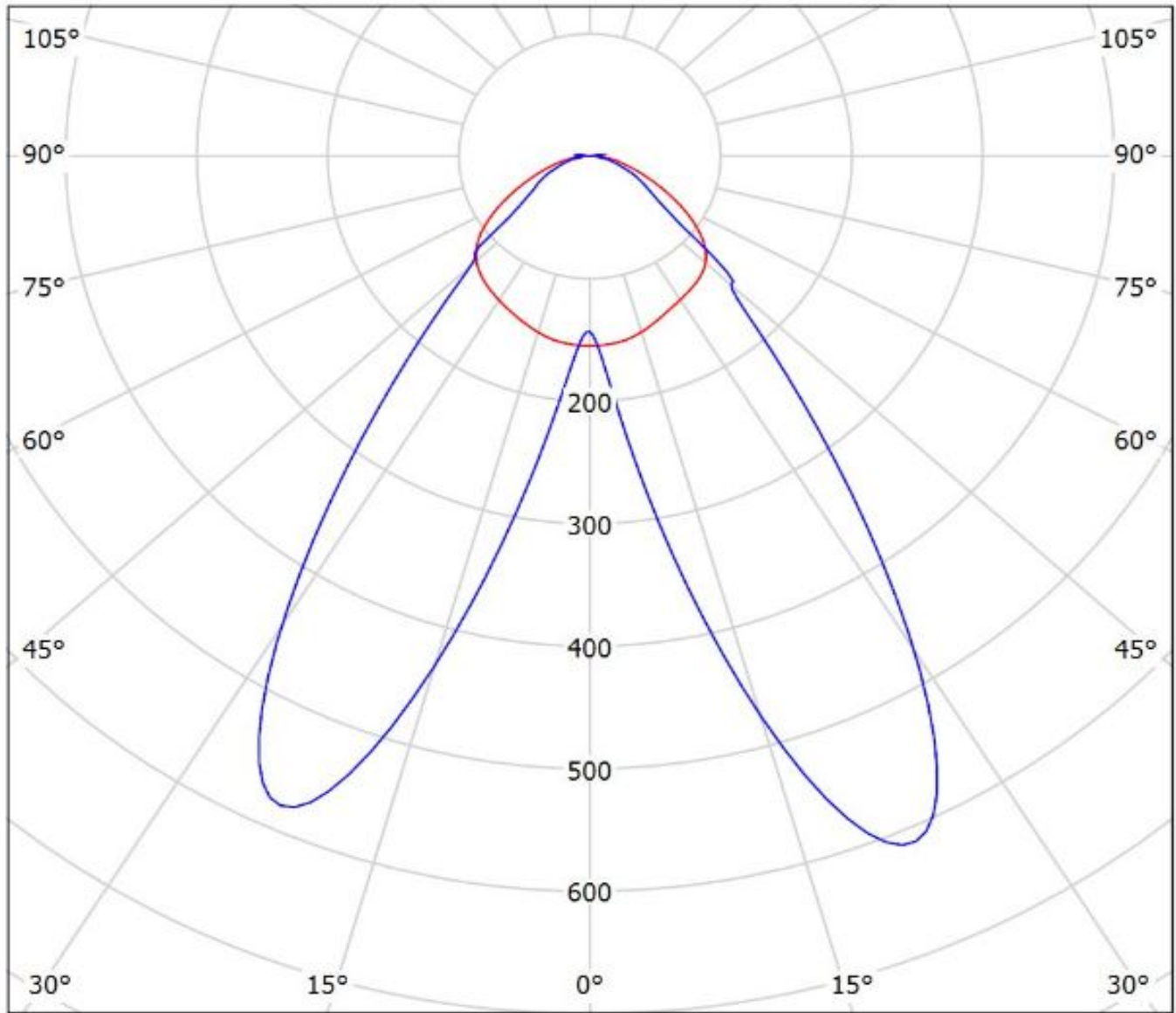

cd/klm

— C0 - C180 — C90 - C270

$\eta = 91\%$

Ledil C14530_FLORENCE-1R-Z2T25_(Luminus_MP-2016) / LDC (Polar)

Luminaire: Ledil C14530_FLORENCE-1R-Z2T25_(Luminus_MP-2016)

Lamps: 1 x Luminus_MP-2016_1x22_(LUMMP-1100-30-80)_471.904lm@120mA_P=4W_I=0.12A

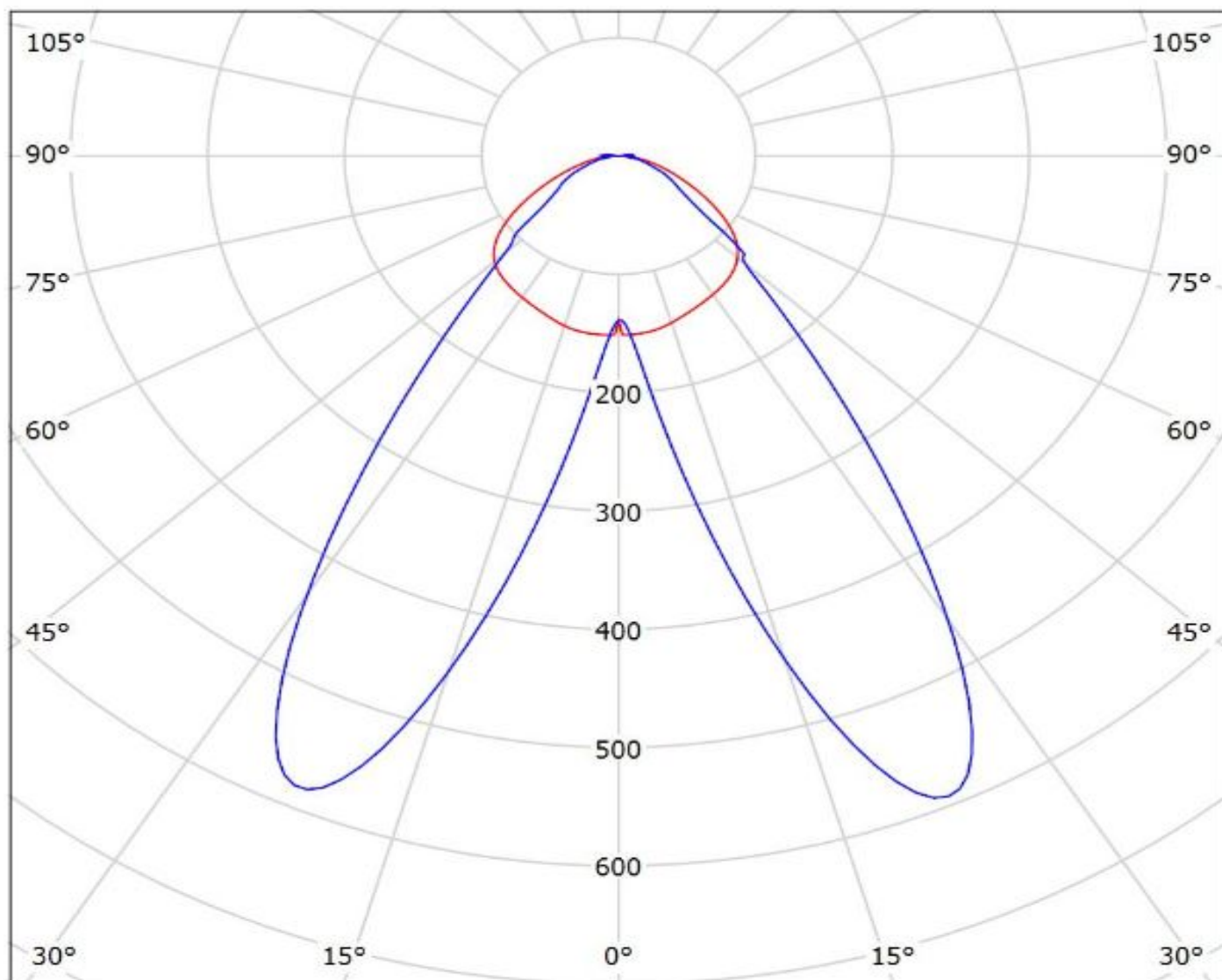

cd/klm

— C0 - C180 — C90 - C270

$\eta = 88\%$

Ledil C14530_FLORENCE-1R-Z2T25_(NF2x757D) / LDC (Polar)

Luminaire: Ledil C14530_FLORENCE-1R-Z2T25_(NF2x757D)

Lamps: 1 x Nichia_NF2x757D_2chip_x22 (NF2W757DRT)_2050.61lm@200mA_P=12.95W_I=0.2A

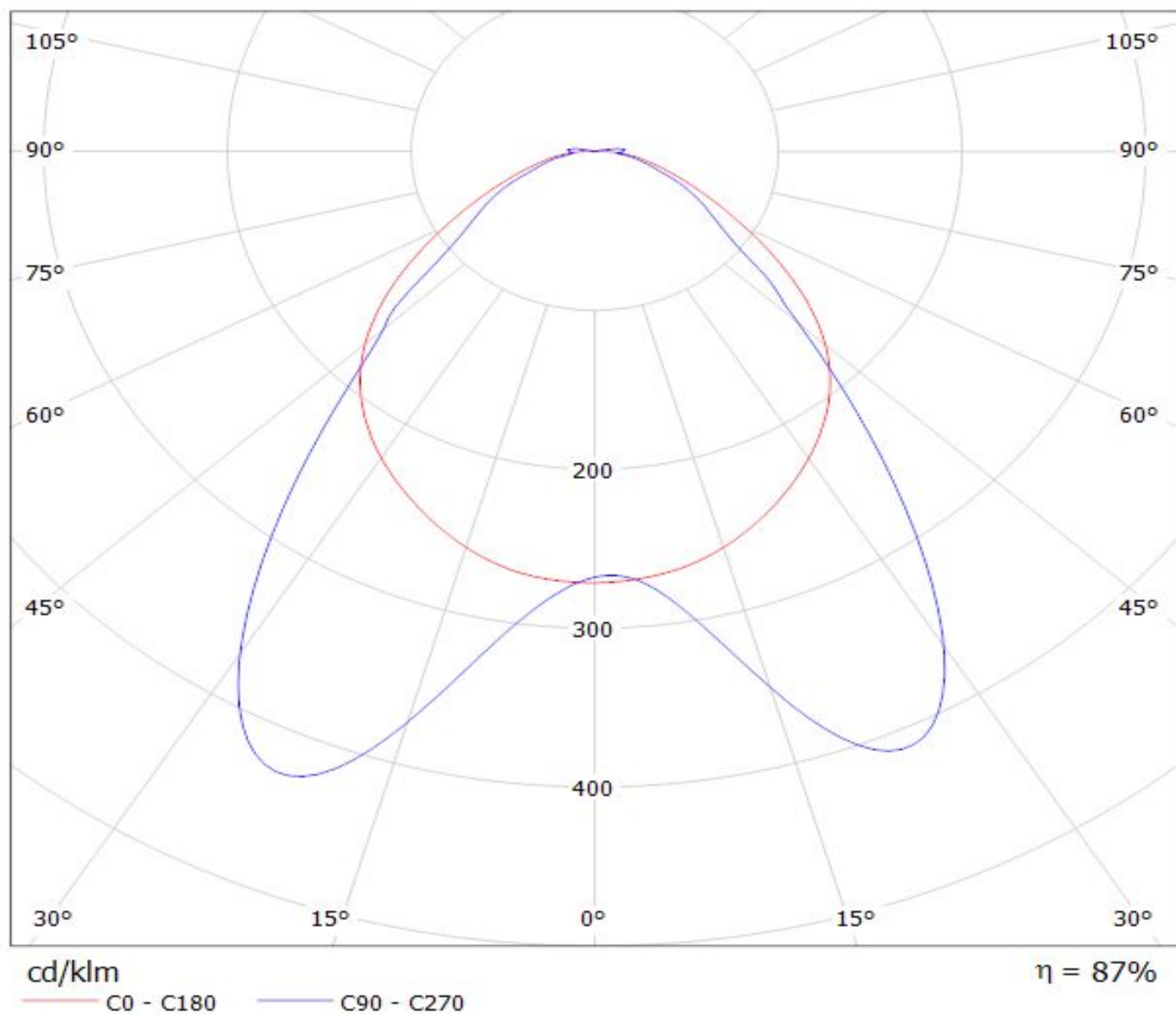

Luminaire: Ledil C14530_FLORENCE-1R-Z2T25_(NF2W757G)
Lamps: 1 x NF2W757G_377.885lm@65mA_CCT=?K_P=1.97W_I=0.065A

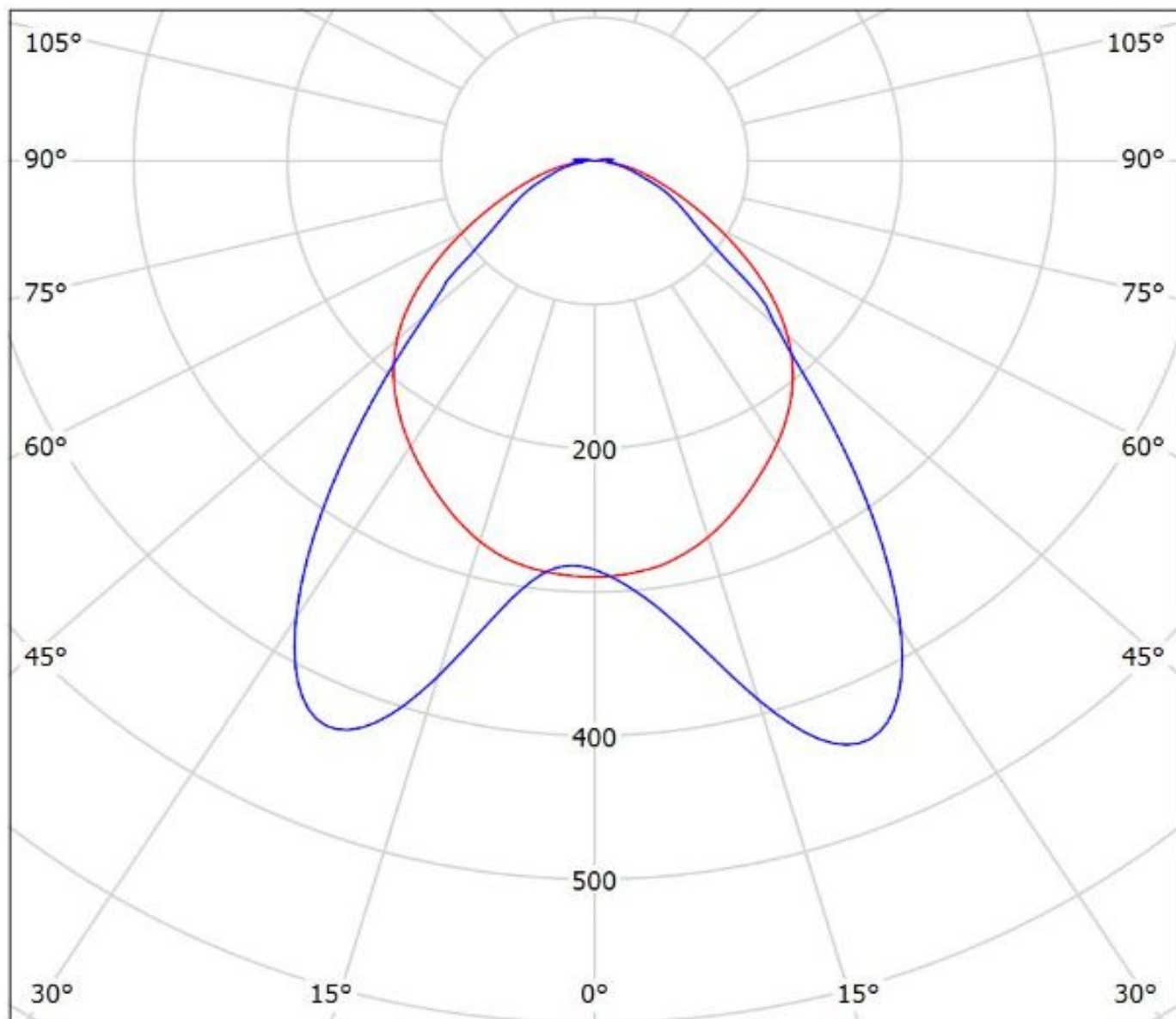

cd/klm
— C0 - C180 — C90 - C270

$\eta = 87\%$

Ledil C14530_FLORENCE-1R-Z2T25_(Duris_S5) / LDC (Polar)

Luminaire: Ledil C14530_FLORENCE-1R-Z2T25_(Duris_S5)

Lamps: 1 x Osram_Duris_S5_x11_(GW_PSLRS1.EC-LQLS-5H7I-1)
_1016.86lm@100mA_P=8W_I=0.1000A

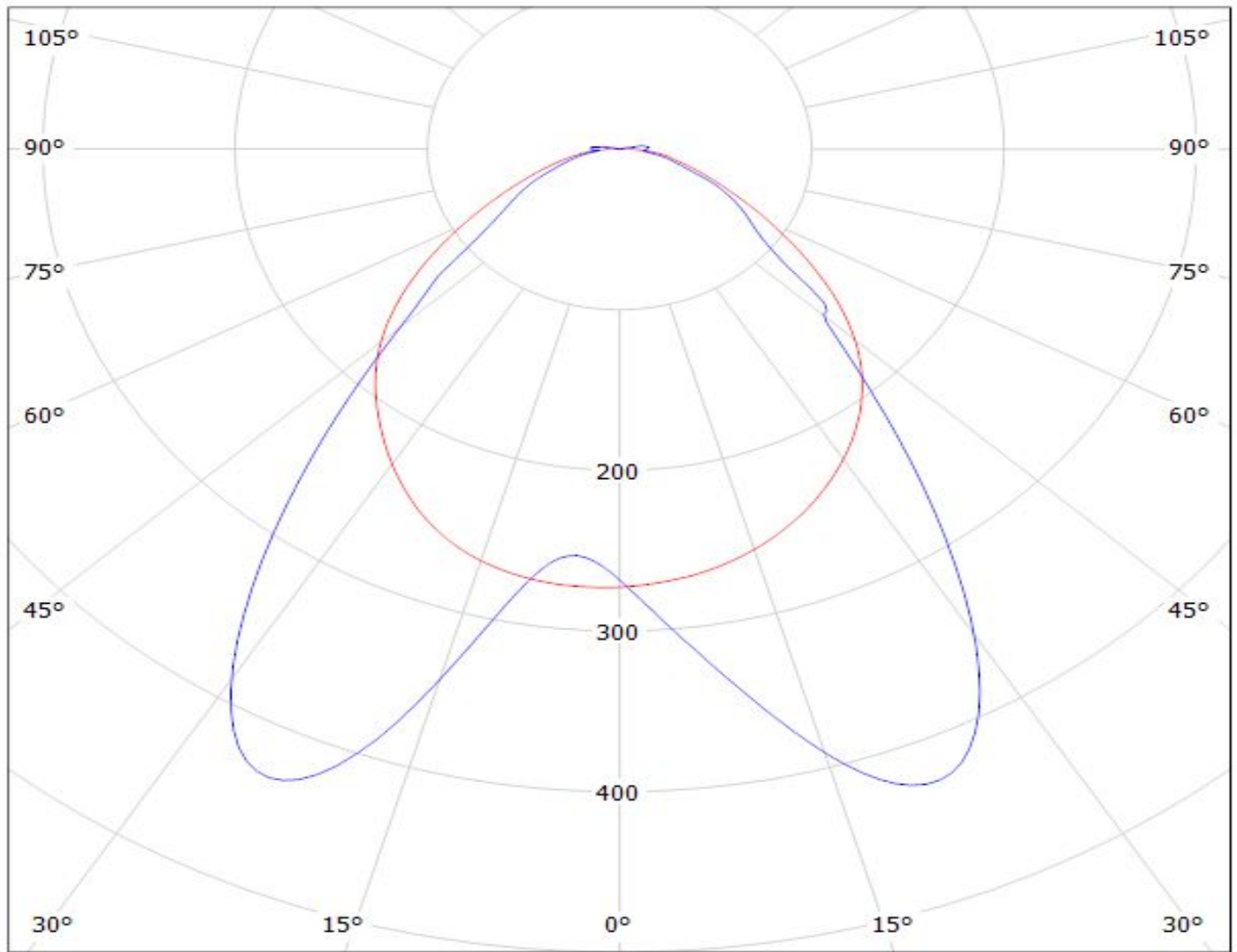

cd/klm

— C0 - C180

— C90 - C270

$\eta = 87\%$

Luminaire: LEDiL Oy C14530_FLORENCE-1R-Z2T25_(Fortimo)

Lamps: 1 x Fortimo_LED_line_1ft_1100lm_840_1R_HV2_1063.26lm@250mA_P=8.02158W_I=0.2498A

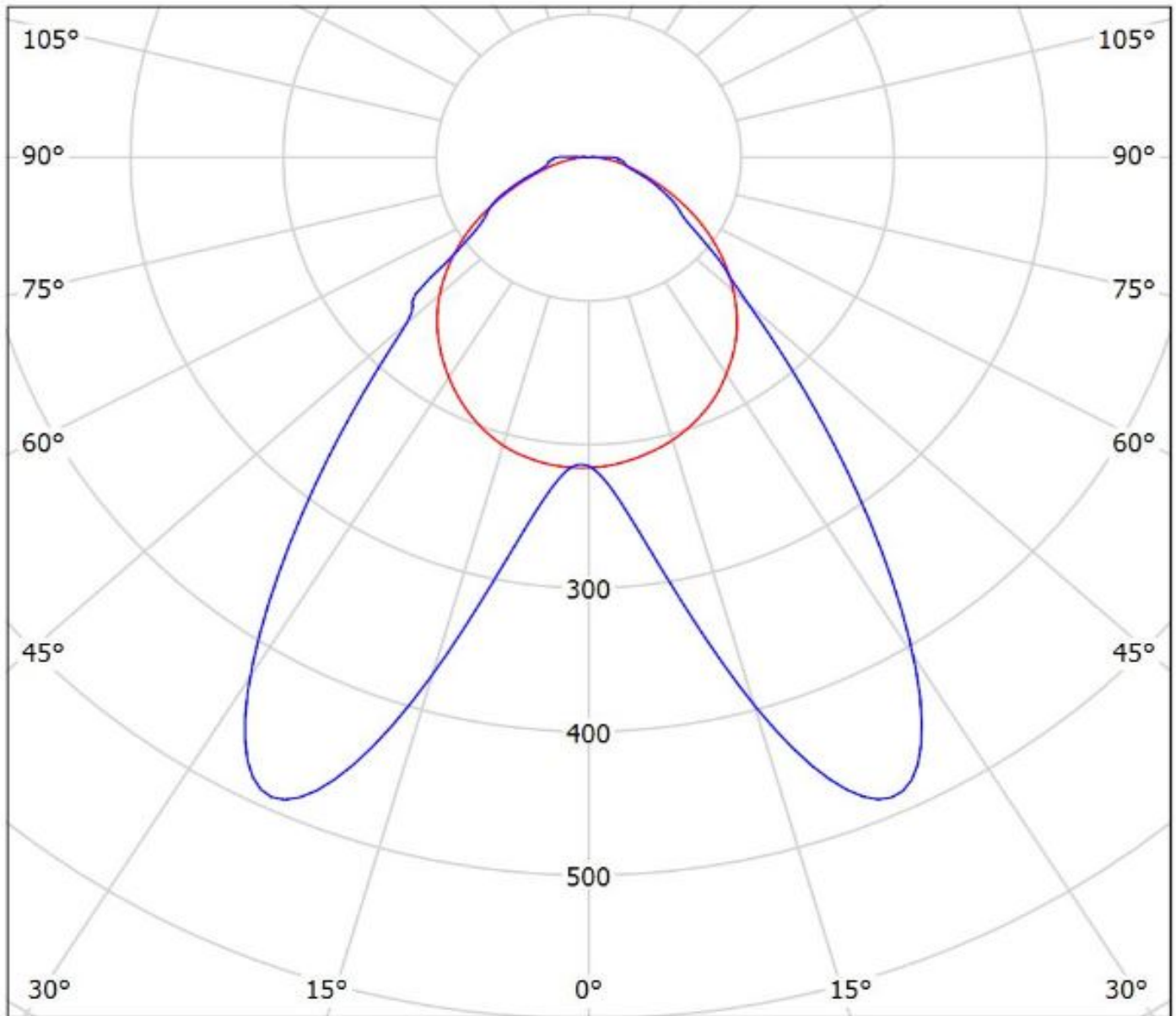

cd/klm

— C0 - C180 — C90 - C270

$\eta = 92\%$

Luminaire: LEDiL Oy C14530_FLORENCE-1R-Z2T25_(LM302A)

Lamps: 1 x Samsung_LM302A_865.46lm@100mA_P=6.64694W_I=0.1001A

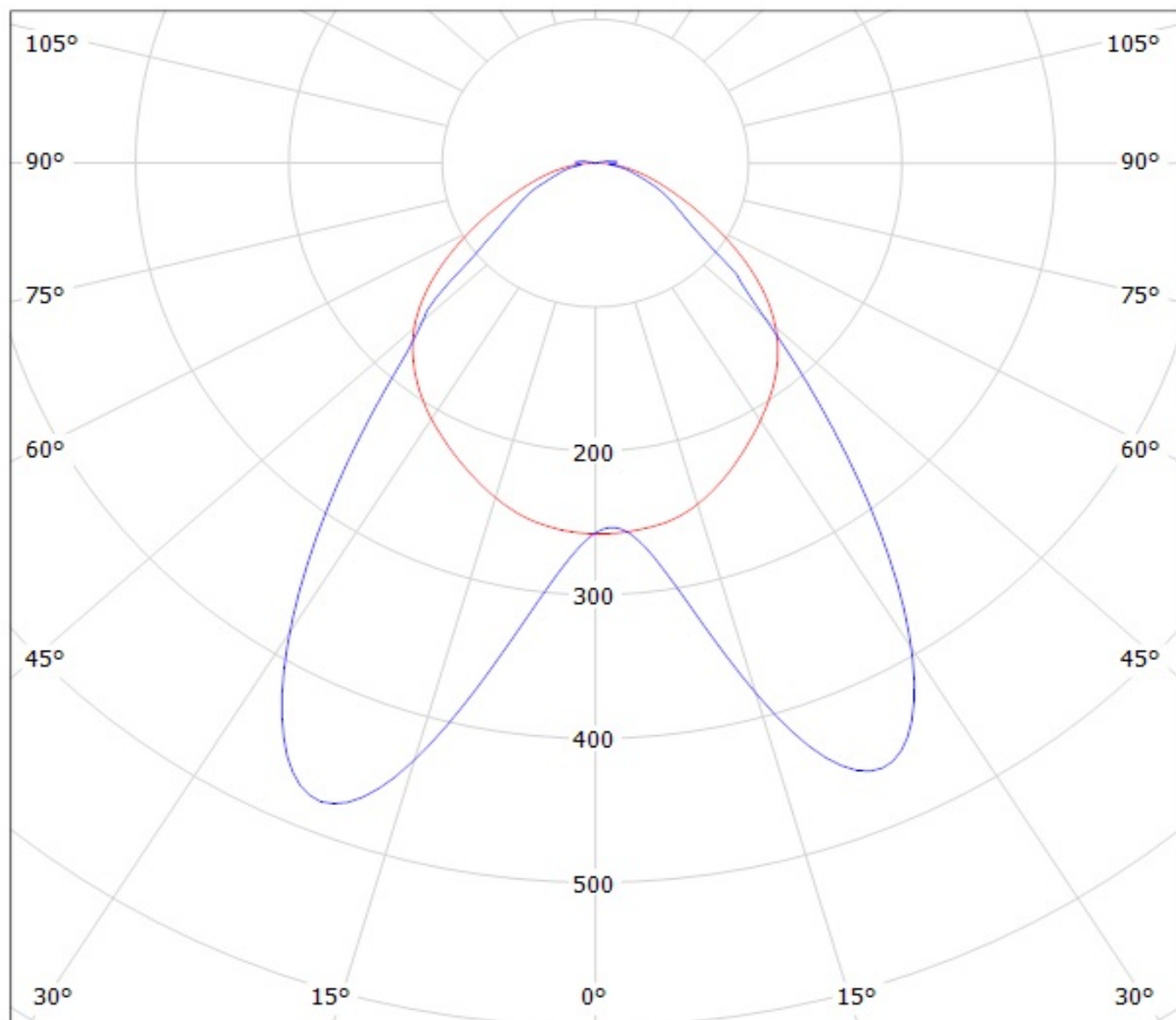

cd/klm

— C0 - C180

— C90 - C270

$\eta = 88\%$

Luminaire: Ledil C14530_FLORENCE-1R-Z2T25_(LM5618+)

Lamps: 1 x Samsung SI-B8T071280LD_LM5618+_1401.55lm@250mA_P=9.185W_I=0.25A

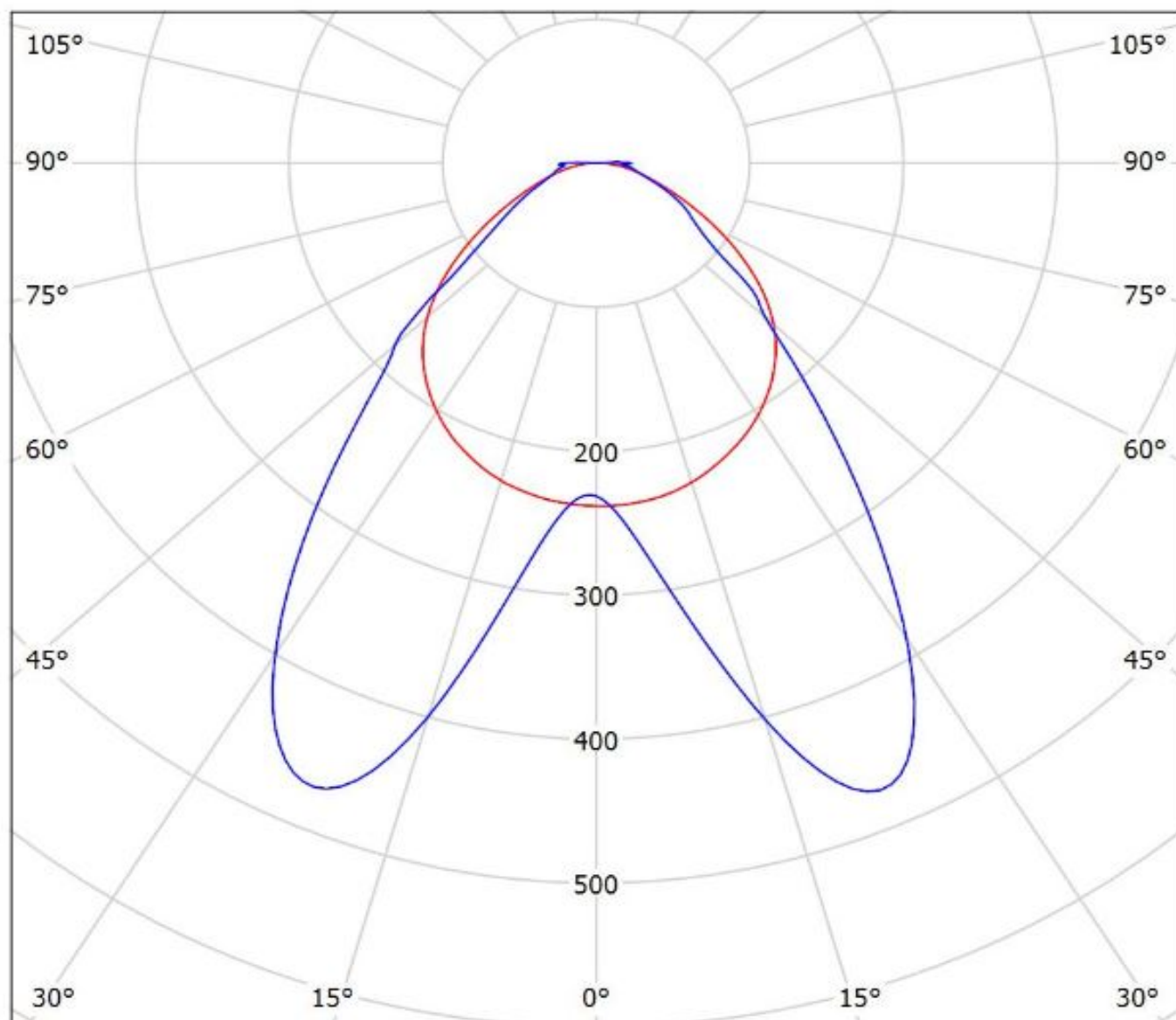

cd/klm

— C0 - C180 — C90 - C270

$\eta = 90\%$

Luminaire: Ledil C14530_FLORENCE-1R-Z2T25_(LM301A)

Lamps: 1 x Samsung_LM301A_x11_(SPMWHT328FD5WAT0S0)_1107.77lm@250mA_P=8.1W_I=0.25A

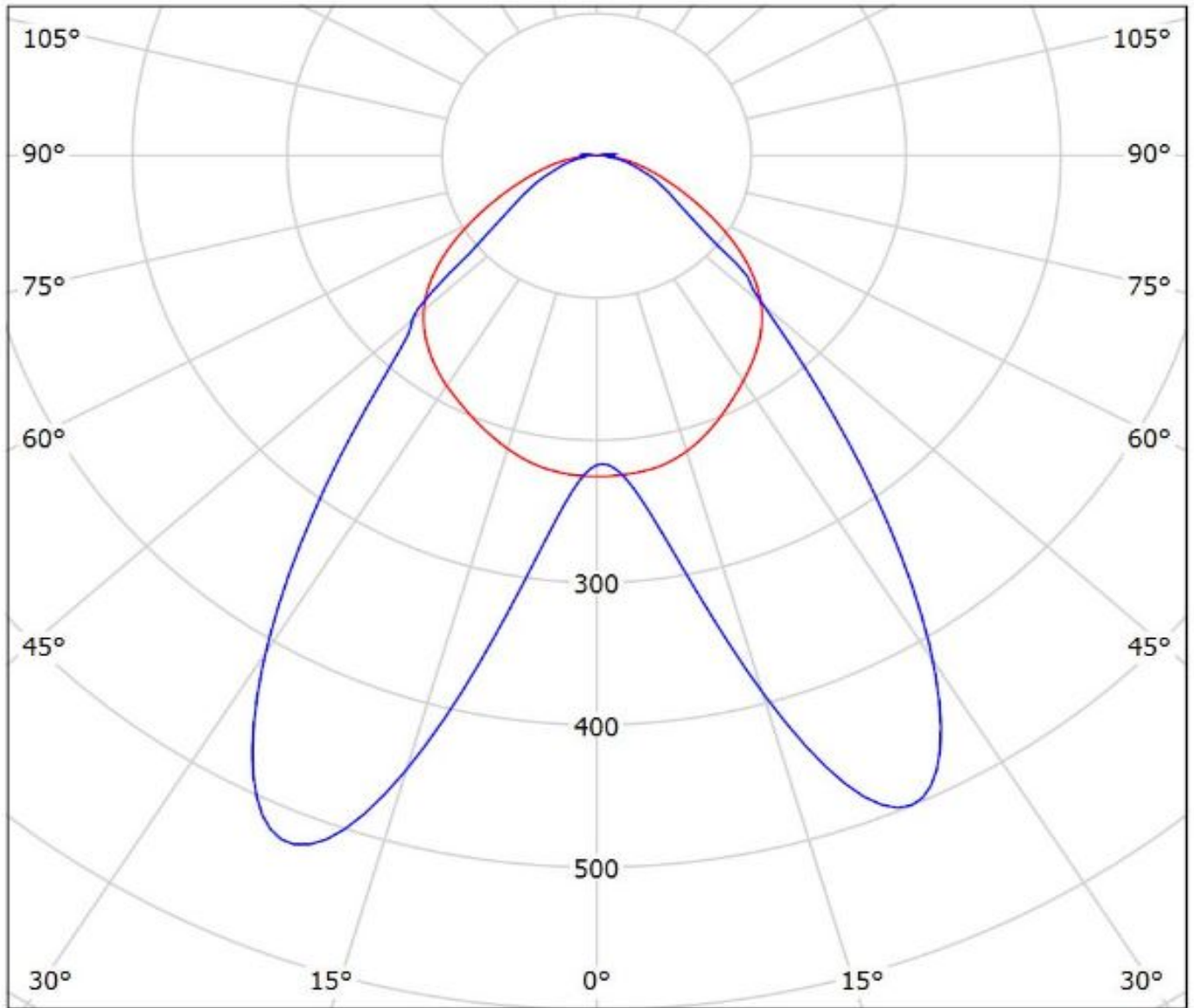

cd/klm

— C0 - C180 — C90 - C270

$\eta = 88\%$

Luminaire: LEDiL Oy C14530_FLORENCE-1R-Z2T25_(LM561C)
Lamps: 1 x Samsung_LM561C_685.154lm@130mA_P=3.9367W_I=0.130A

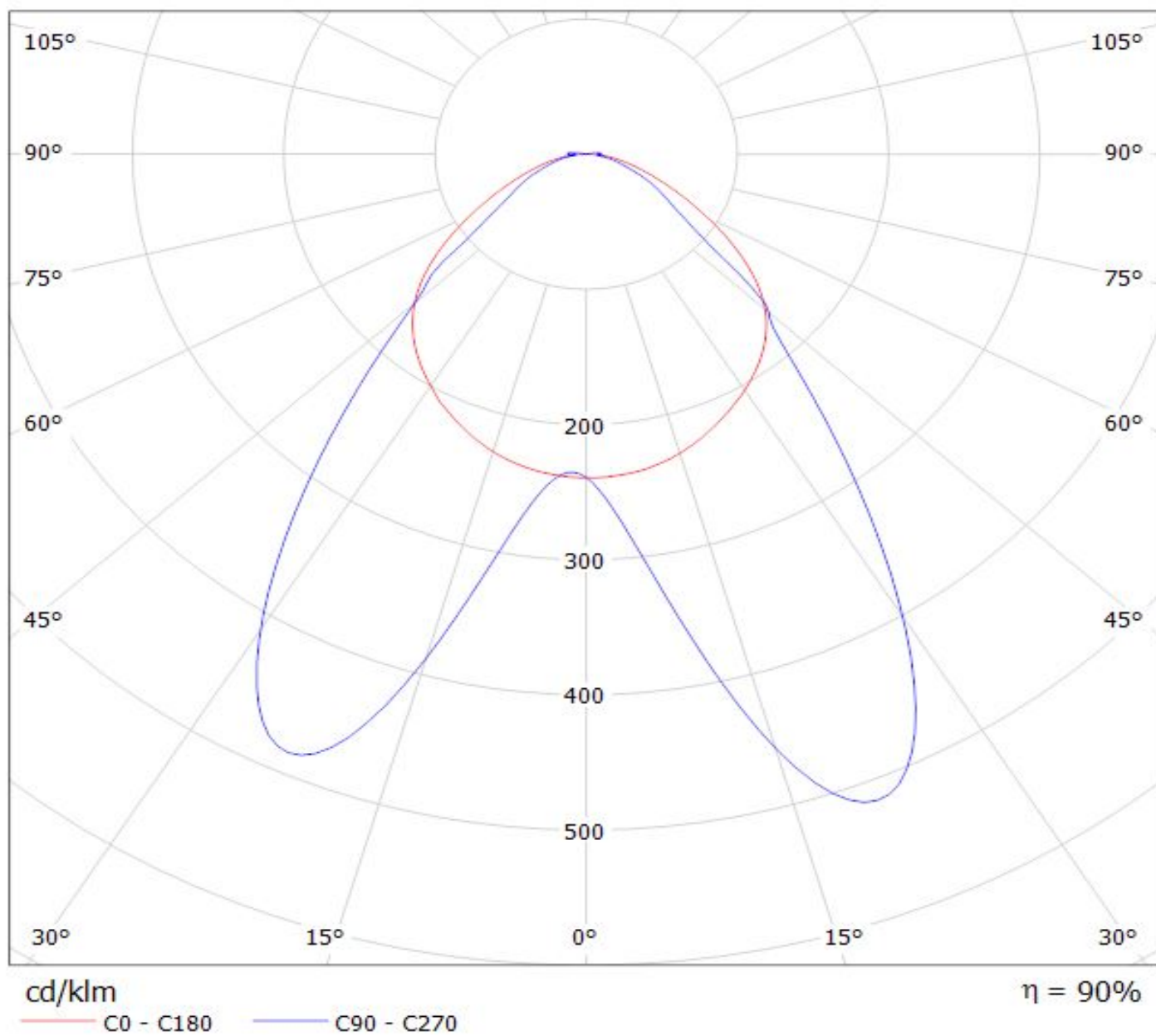

Ledil C14530_FLORENCE-1R-Z2T25_(Seoul_3030) / LDC (Polar)

Luminaire: Ledil C14530_FLORENCE-1R-Z2T25_(Seoul_3030)

Lamps: 1 x Seoul_3030_x11_(STW8C2SA)_785.296lm@100mA_P=6.5W_I=0.1A

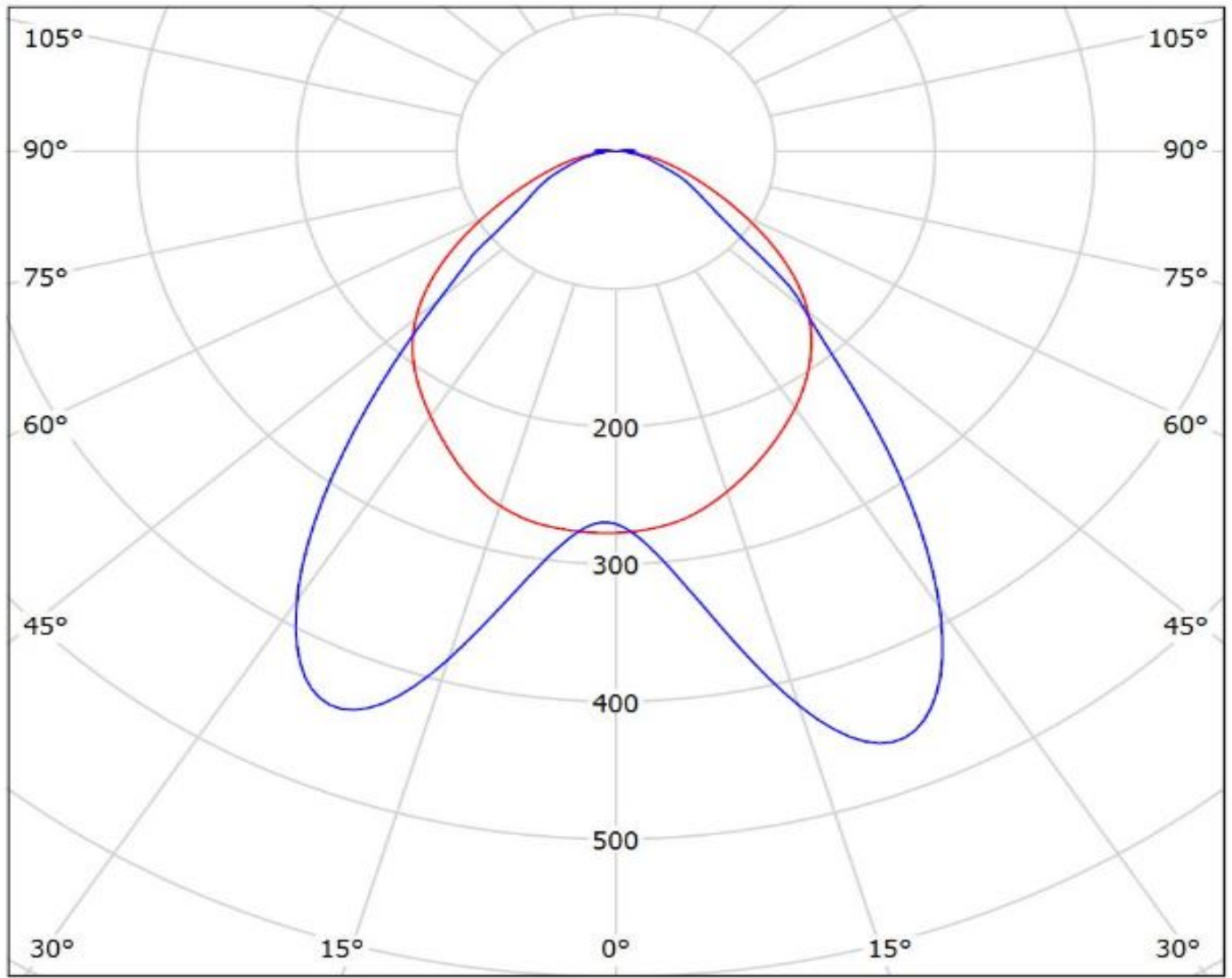

cd/klm

— C0 - C180 — C90 - C270

$\eta = 88\%$

Luminaire: Ledil C14530_FLORENCE-1R-Z2T25_(CALGD0414-M8W1)

Lamps: 1 x Citizen_CALGD0414-M8W1_556.672lm@350mA_P=4.0291W_I=0.3499A

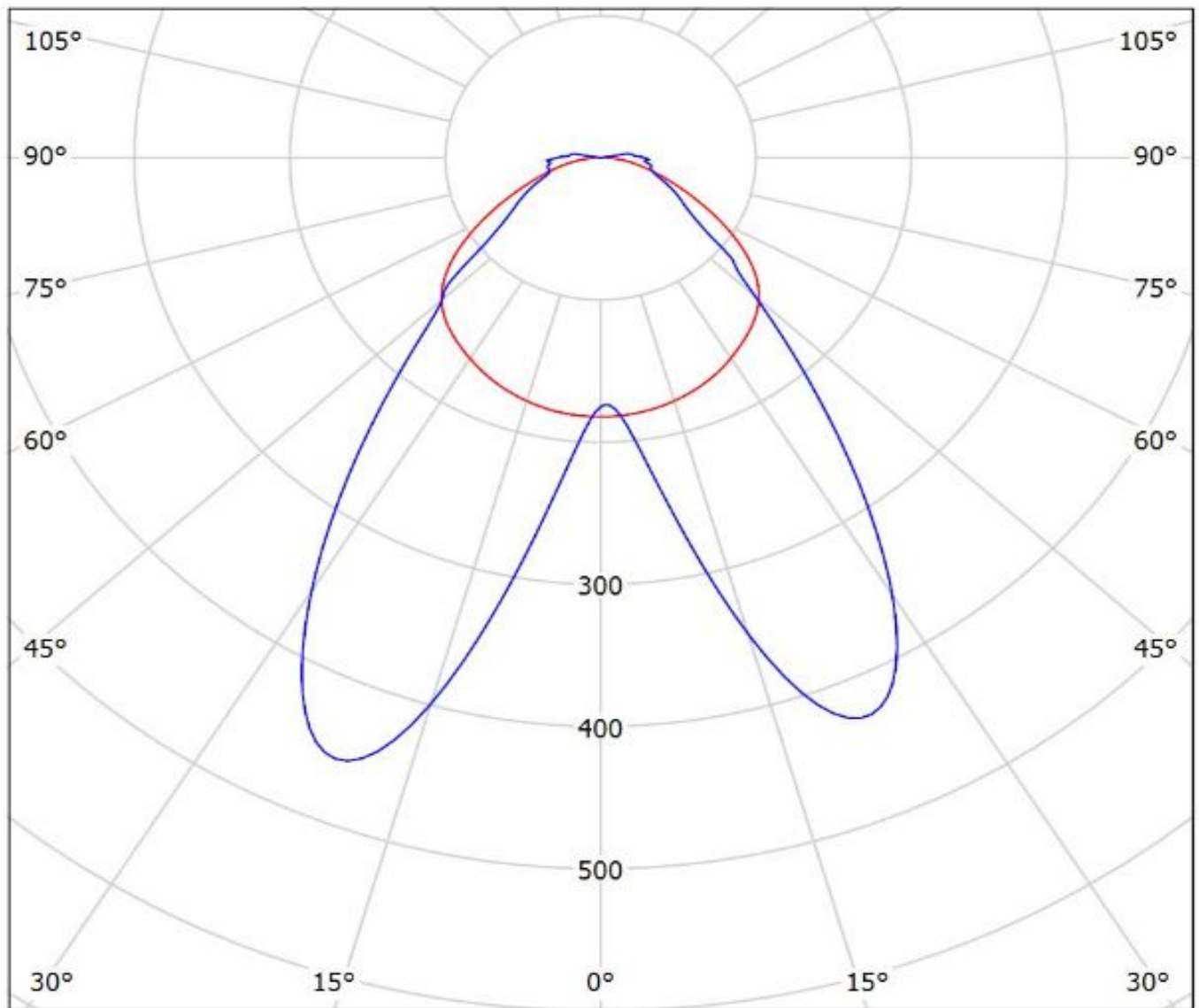

cd/klm

— C0 - C180

— C90 - C270

$\eta = 88\%$

Luminaire: Ledil C14530_FLORENCE-1R-Z2T25_(CALGD0814-M17W1)

Lamps: 1 x Citizen_(CALGD0814-M17W1)_1098.26lm@350mA_P=7.96302W_η=0.3499A

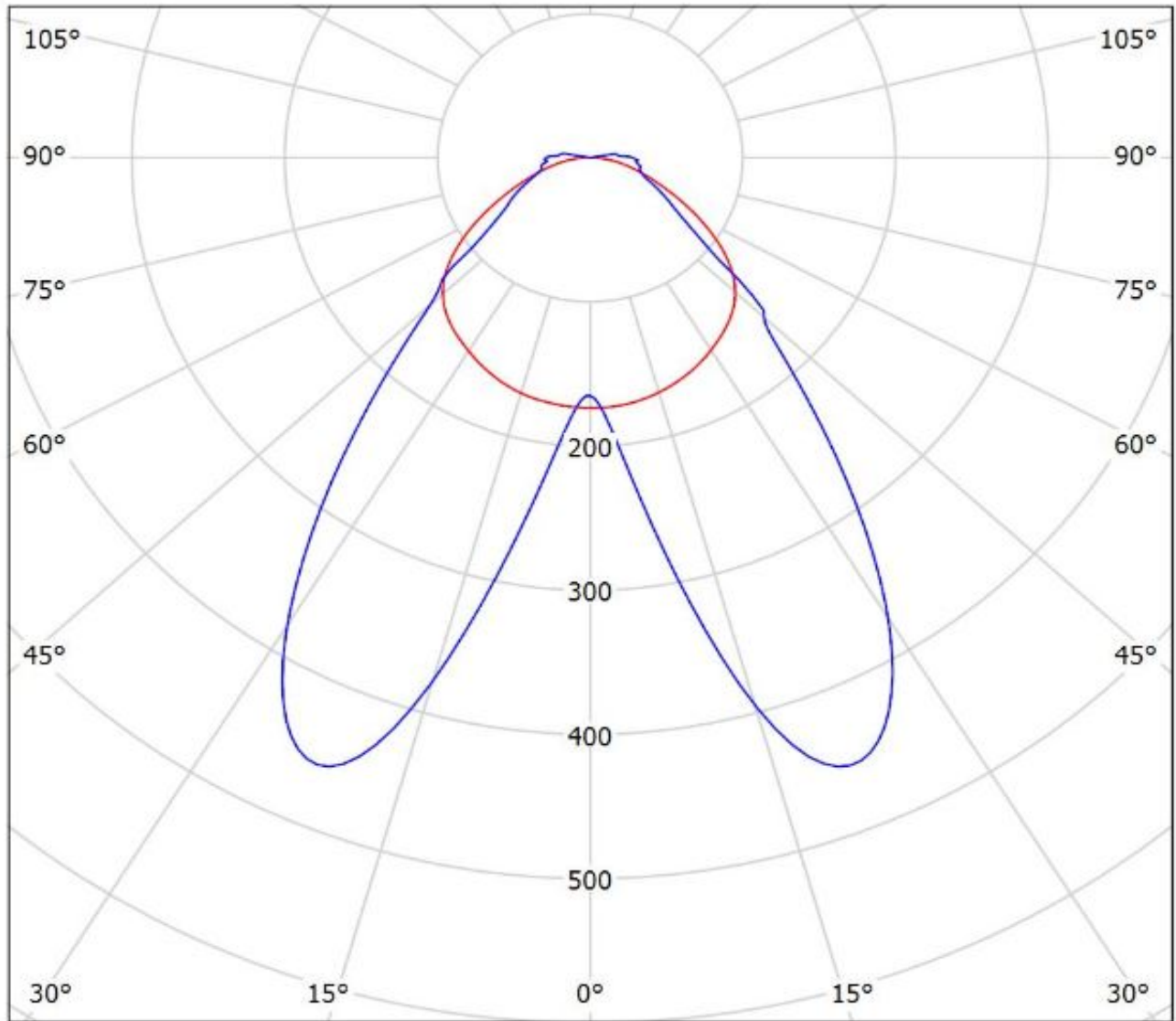

cd/klm

— C0 - C180 — C90 - C270

η = 89%

NOTE: The typical divergence will be changed by different color, chip size and chip position tolerance. The typical total divergence is the full angle measured where the luminous intensity is half of the peak value.