

FEATURES

- Output Current Up to 100mA
- No External Components
- Internal Thermal Overload Protection
- Internal Short-Circuit Limiting
- Output Voltage of 5V, 6V, 8V, 9V, 12V, 15V, 18V and 24V
- Moisture Sensitivity Level 3

DESCRIPTION

This series of fixed-voltage monolithic integrated-circuit voltage regulators is designed for a wide range of applications. These applications include on-card regulation for elimination of noise and distribution problems associated with single-point regulation. In addition, they can be used with power-pass elements to make high current voltage regulators.

Each of these regulators can deliver up to 100mA of output current. The internal limiting and thermal shutdown features of these regulators make them essentially immune to overload. When used as a replacement for a zener diode-resistor combination, an effective improvement in output impedance can be obtained together with lower-bias current.

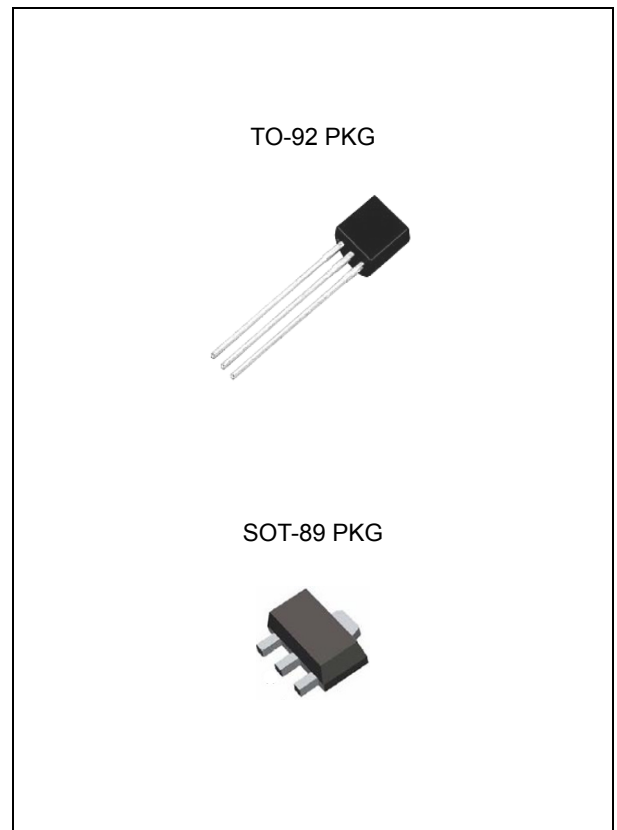

ORDERING INFORMATION

Device	Package
LM79LXX	TO-92 (Bulk)
LM79LXXTA	TO-92 (Taping)
LM79LXXF	SOT-89

XX : Output Voltage = 05, 06, 08, 09, 12, 15, 18, 24

Absolute Maximum Ratings

CHARACTERISTIC		SYMBOL	MIN.	MAX.	UNIT
Input Voltage	LM79L05 ~ LM79L09	V_{IN}	-	-30	V
	LM79L12 ~ LM79L18		-	-35	
	LM79L24		-	-40	
Maximum Power Dissipation at $T_A = 25^\circ\text{C}$ / TO-92		P_{DMax}	-	0.770	W
Thermal Resistance Junction-To-Ambient / TO-92		θ_{JA}	-	162	$^\circ\text{C}/\text{W}$
Lead Temperature (Soldering, 10 sec)		T_{SOL}	-	260	$^\circ\text{C}$
Storage Temperature Range		T_{STG}	-65	150	$^\circ\text{C}$
Operating Junction Temperature Range		T_{JOPR}	0	150	$^\circ\text{C}$

3-TERMINAL 0.1A NEGATIVE VOLTAGE REGULATOR

LM79LXX

Recommended Operating Conditions

CHARACTERISTIC		SYMBOL	MIN.	MAX.	UNIT
Input Voltage	LM79L05	V_{IN}	-7	-20	V
	LM79L06		-8	-20	
	LM79L08		-10.5	-23	
	LM79L09		-11.5	-24	
	LM79L12		-14.5	-27	
	LM79L15		-17.5	-30	
	LM79L18		-20.5	-33	
	LM79L24		-27	-38	
Output Current		I_O	-	100	mA
Operating Virtual Junction Temperature		T_J	0	125	°C

Ordering Information

V_{OUT}	Package	Order No.	Description	Supplied As	Status
5.0V	TO-92	LM79L05	0.1A, Negative	Bulk	Active
		LM79L05TA	0.1A, Negative	Taping	Active
	SOT-89	LM79L05F	0.1A, Negative	Reel	Active
6.0V	TO-92	LM79L06	0.1A, Negative	Bulk	Active
		LM79L06TA	0.1A, Negative	Taping	Active
	SOT-89	LM79L06F	0.1A, Negative	Reel	Active
8.0V	TO-92	LM79L08	0.1A, Negative	Bulk	Active
		LM79L08TA	0.1A, Negative	Taping	Active
	SOT-89	LM79L08F	0.1A, Negative	Reel	Active
9.0V	TO-92	LM79L09	0.1A, Negative	Bulk	Active
		LM79L09TA	0.1A, Negative	Taping	Active
	SOT-89	LM79L09F	0.1A, Negative	Reel	Active
12V	TO-92	LM79L12	0.1A, Negative	Bulk	Active
		LM79L12TA	0.1A, Negative	Taping	Active
	SOT-89	LM79L12F	0.1A, Negative	Reel	Active
15V	TO-92	LM79L15	0.1A, Negative	Bulk	Active
		LM79L15TA	0.1A, Negative	Taping	Active
	SOT-89	LM79L15F	0.1A, Negative	Reel	Active

3-TERMINAL 0.1A NEGATIVE VOLTAGE REGULATOR

LM79LXX

Ordering Information (Continued)

V _{OUT}	Package	Order No.	Description	Supplied As	Status
18V	TO-92	LM79L18	0.1A, Negative	Bulk	Active
		LM79L18TA	0.1A, Negative	Taping	Active
	SOT-89	LM79L18F	0.1A, Negative	Reel	Active
24V	TO-92	LM79L24	0.1A, Negative	Bulk	Active
		LM79L24TA	0.1A, Negative	Taping	Active
	SOT-89	LM79L24F	0.1A, Negative	Reel	Active

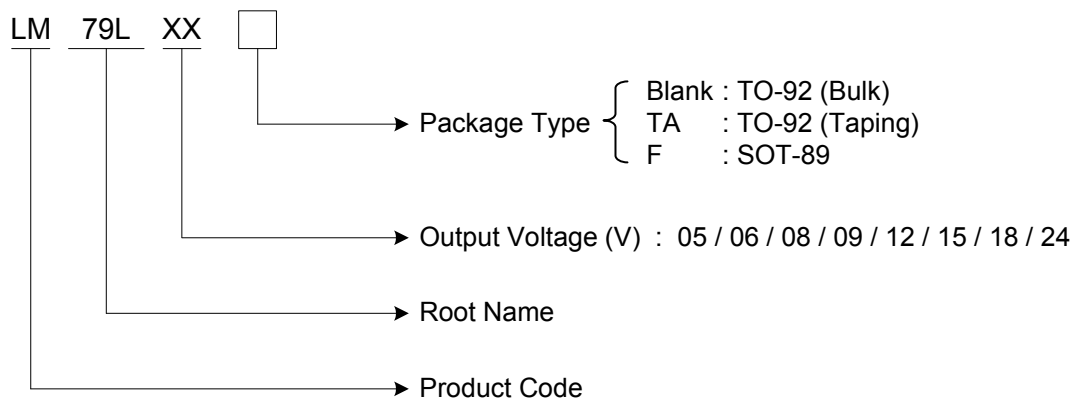

PIN CONFIGURATION

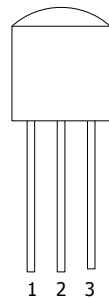

TO-92

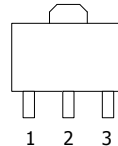

SOT-89

PIN DESCRIPTION

Pin No.	TO-92 / SOT-89 3 LEAD	
	Name	Function
1	GND	Ground
2	V _{IN}	Input Voltage
3	V _{OUT}	Output Voltage

TYPICAL APPLICATION

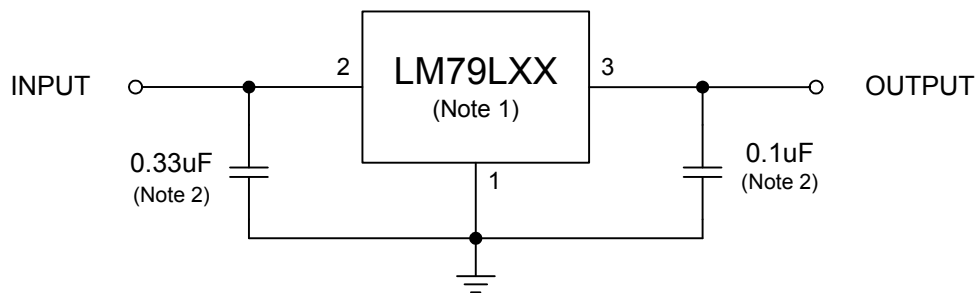

Note 1. To specify an output voltage, substitute voltage for "XX".

Note 2. Bypass capacitors are recommended for optimum stability and transient response and should be located as close as possible to the regulators.

3-TERMINAL 0.1A NEGATIVE VOLTAGE REGULATOR

LM79LXX

ELECTRICAL CHARACTERISTICS

LM79L05 (At specified virtual junction temperature, $V_{IN} = 10V$, $I_o = 40mA$ (Unless otherwise noted))

PARAMETER	SYMBOL	TEST CONDITION ^(Note 1)		MIN.	TYP.	MAX.	UNIT
Output Voltage ^(Note 2)	V_{OUT}		25°C	-4.8	-5	-5.2	V
		$1mA \leq I_o \leq 40mA$ $-7V \leq V_{IN} \leq 20V$	0°C ~ 125°C	-4.75	-5	-5.25	
		$1mA \leq I_o \leq 70mA$		-4.75	-5	-5.25	
Line Regulation	ΔV_{LINE}	$-7V \leq V_{IN} \leq -20V$	25°C		32	150	mV
		$-8V \leq V_{IN} \leq -20V$			26	100	
Load Regulation	ΔV_{LOAD}	$1mA \leq I_o \leq 100mA$	25°C		15	60	mV
		$1mA \leq I_o \leq 40mA$			8	30	
Bias Current	I_B		25°C		3.8	6	mA
			125°C			5.5	
Bias Current Change	ΔI_B	$-8V \leq V_{IN} \leq -20V$	0°C ~ 125°C			1.5	mA
		$1mA \leq I_o \leq 40mA$				0.1	
Output Noise Voltage	V_N	$10Hz \leq f \leq 100kHz$	25°C		42		µV
Ripple Rejection	RR	$-8V \leq V_{IN} \leq -18V$, $f=120Hz$	25°C	41	49		dB
Dropout Voltage	V_D		25°C		1.7		V

LM79L06 (At specified virtual junction temperature, $V_{IN} = 11V$, $I_o = 40mA$ (Unless otherwise noted))

PARAMETER	SYMBOL	TEST CONDITION ^(Note 1)		MIN.	TYP.	MAX.	UNIT
Output Voltage ^(Note 2)	V_{OUT}		25°C	-5.76	-6	-6.24	V
		$1mA \leq I_o \leq 40mA$ $-8V \leq V_{IN} \leq -21V$	0°C ~ 125°C	-5.7	-6	-6.3	
		$1mA \leq I_o \leq 70mA$		-5.7	-6	-6.3	
Line Regulation	ΔV_{LINE}	$-8V \leq V_{IN} \leq -21V$	25°C		50	150	mV
		$-9V \leq V_{IN} \leq -21V$			45	110	
Load Regulation	ΔV_{LOAD}	$1mA \leq I_o \leq 100mA$	25°C		12	70	mV
		$1mA \leq I_o \leq 40mA$			5.5	35	
Bias Current	I_B		25°C			6	mA
			125°C			5.5	
Bias Current Change	ΔI_B	$-9V \leq V_{IN} \leq -21V$	0°C ~ 125°C			1.5	mA
		$1mA \leq I_o \leq 40mA$				0.1	
Output Noise Voltage	V_N	$10Hz \leq f \leq 100kHz$	25°C		50		µV
Ripple Rejection	RR	$-9V \leq V_{IN} \leq -19V$, $f=120Hz$	25°C	39	47		dB
Dropout Voltage	V_D		25°C		1.7		V

3-TERMINAL 0.1A NEGATIVE VOLTAGE REGULATOR

LM79LXX

LM79L08 (At specified virtual junction temperature, $V_{IN} = 14V$, $I_o = 40mA$ (Unless otherwise noted))

PARAMETER	SYMBOL	TEST CONDITION ^(Note 1)		MIN.	TYP.	MAX.	UNIT
Output Voltage ^(Note 2)	V_{OUT}		25°C	-7.7	-8	-8.3	V
		$1mA \leq I_o \leq 40mA$ $-10.5V \leq V_{IN} \leq -23V$	0°C ~ 125°C	-7.6	-8	-8.4	
		$1mA \leq I_o \leq 70mA$		-7.6	-8	-8.4	
Line Regulation	ΔV_{LINE}	$-10.5V \leq V_{IN} \leq -23V$	25°C		20	175	mV
		$-11V \leq V_{IN} \leq -23V$			12	125	
Load Regulation	ΔV_{LOAD}	$1mA \leq I_o \leq 100mA$	25°C		18	80	mV
		$1mA \leq I_o \leq 40mA$			9	42	
Bias Current	I_B		25°C			6.5	mA
			125°C			6	
Bias Current Change	ΔI_B	$-11V \leq V_{IN} \leq -23V$	0°C ~ 125°C			1.5	mA
		$1mA \leq I_o \leq 40mA$				0.1	
Output Noise Voltage	V_N	$10Hz \leq f \leq 100kHz$	25°C		60		uV
Ripple Rejection	RR	$-12V \leq V_{IN} \leq -23V$, $f=120Hz$	25°C	42	49		dB
Dropout Voltage	V_D		25°C		1.7		V

LM79L09 (At specified virtual junction temperature, $V_{IN} = 15V$, $I_o = 40mA$ (Unless otherwise noted))

PARAMETER	SYMBOL	TEST CONDITION ^(Note 1)		MIN.	TYP.	MAX.	UNIT
Output Voltage ^(Note 2)	V_{OUT}		25°C	-8.64	-9	-9.36	V
		$1mA \leq I_o \leq 40mA$ $-11V \leq V_{IN} \leq -24V$	0°C ~ 125°C	-8.55	9	-9.45	
		$1mA \leq I_o \leq 70mA$		-8.55	9	-9.45	
Line Regulation	ΔV_{LINE}	$-11V \leq V_{IN} \leq -24V$	25°C		80	200	mV
		$-12V \leq V_{IN} \leq -24V$			20	160	
Load Regulation	ΔV_{LOAD}	$1mA \leq I_o \leq 100mA$	25°C		17	90	mV
		$1mA \leq I_o \leq 40mA$			8	45	
Bias Current	I_B		25°C		3.8	6.5	mA
			125°C			6	
Bias Current Change	ΔI_B	$-12V \leq V_{IN} \leq -24V$	0°C ~ 125°C			1.5	mA
		$1mA \leq I_o \leq 40mA$				0.1	
Output Noise Voltage	V_N	$10Hz \leq f \leq 100kHz$	25°C		64		uV
Ripple Rejection	RR	$-8V \leq V_{IN} \leq -18V$, $f=120Hz$	25°C	35	43		dB
Dropout Voltage	V_D		25°C		1.7		V

3-TERMINAL 0.1A NEGATIVE VOLTAGE REGULATOR

LM79LXX

LM79L12 (At specified virtual junction temperature, $V_{IN} = 19V$, $I_o = 40mA$ (Unless otherwise noted))

PARAMETER	SYMBOL	TEST CONDITION ^(Note 1)		MIN.	TYP.	MAX.	UNIT
Output Voltage ^(Note 2)	V_{OUT}		25°C	-11.5	-12	-12.5	V
		$1mA \leq I_o \leq 40mA$ $-14.5V \leq V_{IN} \leq -27V$	0°C ~ 125°C	-11.4	-12	-12.6	
		$1mA \leq I_o \leq 70mA$		-11.4	-12	-12.6	
Line Regulation	ΔV_{LINE}	$-14.5V \leq V_{IN} \leq -27V$	25°C		50	250	mV
		$-16V \leq V_{IN} \leq -27V$			40	200	
Load Regulation	ΔV_{LOAD}	$1mA \leq I_o \leq 100mA$	25°C		24	100	mV
		$1mA \leq I_o \leq 40mA$			15	50	
Bias Current	I_B		25°C			6.5	mA
			125°C			6	
Bias Current Change	ΔI_B	$-16V \leq V_{IN} \leq -27V$	0°C ~ 125°C			1.5	mA
		$1mA \leq I_o \leq 40mA$				0.1	
Output Noise Voltage	V_N	$10Hz \leq f \leq 100kHz$	25°C		70		uV
Ripple Rejection	RR	$-15V \leq V_{IN} \leq -25V$, $f=120Hz$	25°C	37	42		dB
Dropout Voltage	V_D		25°C		1.7		V

LM79L15 (At specified virtual junction temperature, $V_{IN} = 23V$, $I_o = 40mA$ (Unless otherwise noted))

PARAMETER	SYMBOL	TEST CONDITION ^(Note 1)		MIN.	TYP.	MAX.	UNIT
Output Voltage ^(Note 2)	V_{OUT}		25°C	-14.4	-15	-15.6	V
		$1mA \leq I_o \leq 40mA$ $-17.5V \leq V_{IN} \leq -30V$	0°C ~ 125°C	-14.25	-15	-15.75	
		$1mA \leq I_o \leq 70mA$		-14.25	-15	-15.75	
Line Regulation	ΔV_{LINE}	$-17.5V \leq V_{IN} \leq -30V$	25°C		65	300	mV
		$-27V \leq V_{IN} \leq -30V$			58	250	
Load Regulation	ΔV_{LOAD}	$1mA \leq I_o \leq 100mA$	25°C		25	150	mV
		$1mA \leq I_o \leq 40mA$			15	75	
Bias Current	I_B		25°C		4.2	6.5	mA
			125°C			6	
Bias Current Change	ΔI_B	$-20V \leq V_{IN} \leq -30V$	0°C ~ 125°C			1.5	mA
		$1mA \leq I_o \leq 40mA$				0.1	
Output Noise Voltage	V_N	$10Hz \leq f \leq 100kHz$	25°C		82		uV
Ripple Rejection	RR	$-18.5V \leq V_{IN} \leq -28.5V$, $f=120Hz$	25°C	37	44		dB
Dropout Voltage	V_D		25°C		1.7		V

3-TERMINAL 0.1A NEGATIVE VOLTAGE REGULATOR

LM79LXX

LM79L18 (At specified virtual junction temperature, $V_{IN} = 26V$, $I_o = 40mA$ (Unless otherwise noted))

PARAMETER	SYMBOL	TEST CONDITION ^(Note 1)		MIN.	TYP.	MAX.	UNIT
Output Voltage ^(Note 2)	V_{OUT}		25°C	-17.3	-18	-18.7	V
		$1mA \leq I_o \leq 40mA$ $-20.5V \leq V_{IN} \leq -33V$	0°C ~ 125°C	-17.1	-18	-18.9	
		$1mA \leq I_o \leq 70mA$		-17.1	-18	-18.9	
Line Regulation	ΔV_{LINE}	$-20.7V \leq V_{IN} \leq -33V$	25°C		70	360	mV
		$-21V \leq V_{IN} \leq -33V$			64	300	
Load Regulation	ΔV_{LOAD}	$1mA \leq I_o \leq 100mA$	25°C		27	180	mV
		$1mA \leq I_o \leq 40mA$			19	90	
Bias Current	I_B		25°C		4.7	6.5	mA
			125°C			6	
Bias Current Change	ΔI_B	$-21V \leq V_{IN} \leq -33V$	0°C ~ 125°C			1.5	mA
		$1mA \leq I_o \leq 40mA$				0.1	
Output Noise Voltage	V_N	$10Hz \leq f \leq 100kHz$	25°C		82		uV
Ripple Rejection	RR	$-23V \leq V_{IN} \leq -33V$, $f=120Hz$	25°C	32	36		dB
Dropout Voltage	V_D		25°C		1.7		V

LM79L24 (At specified virtual junction temperature, $V_{IN} = 32V$, $I_o = 40mA$ (Unless otherwise noted))

PARAMETER	SYMBOL	TEST CONDITION ^(Note 1)		MIN.	TYP.	MAX.	UNIT
Output Voltage ^(Note 2)	V_{OUT}		25°C	-23	-24	-25	V
		$1mA \leq I_o \leq 40mA$ $-27V \leq V_{IN} \leq -38V$	0°C ~ 125°C	-22.8	-24	-25.2	
		$1mA \leq I_o \leq 70mA$		-22.8	-24	-25.2	
Line Regulation	ΔV_{LINE}	$-27V \leq V_{IN} \leq -38V$	25°C		95	480	mV
		$-28V \leq V_{IN} \leq -38V$			78	400	
Load Regulation	ΔV_{LOAD}	$1mA \leq I_o \leq 100mA$	25°C		41	240	mV
		$1mA \leq I_o \leq 40mA$			28	120	
Bias Current	I_B		25°C		4.8	6.5	mA
			125°C			6	
Bias Current Change	ΔI_B	$-21V \leq V_{IN} \leq -38V$	0°C ~ 125°C			1.5	mA
		$1mA \leq I_o \leq 40mA$				0.1	
Output Noise Voltage	V_N	$10Hz \leq f \leq 100kHz$	25°C		82		uV
Ripple Rejection	RR	$-29V \leq V_{IN} \leq -35V$, $f=120Hz$	25°C	30	33		dB
Dropout Voltage	V_D		25°C		1.7		V

- Note 1. Pulse testing techniques are used to maintain the junction temperature as close to the ambient temperature as possible. Thermal effects must be taken into account separately.
All characteristics are measured with a 0.33 μ F capacitor across the input and a 0.1 μ F capacitor across the output.
- Note 2. This specification applies only for DC power dissipation permitted by absolute maximum ratings.

TYPICAL OPERATING CHARACTERISTICS

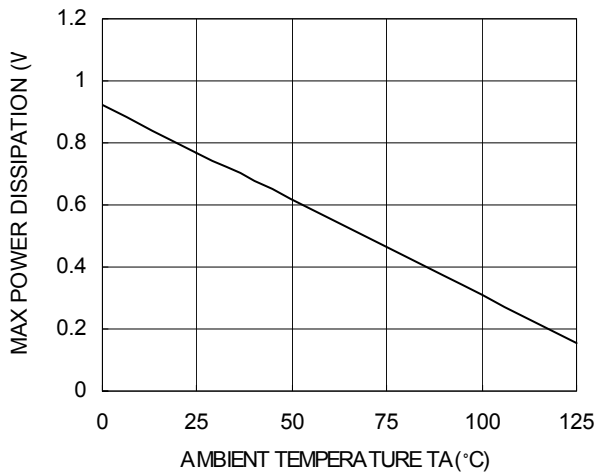

Power Dissipation vs. Ambient Temperature, TO-92

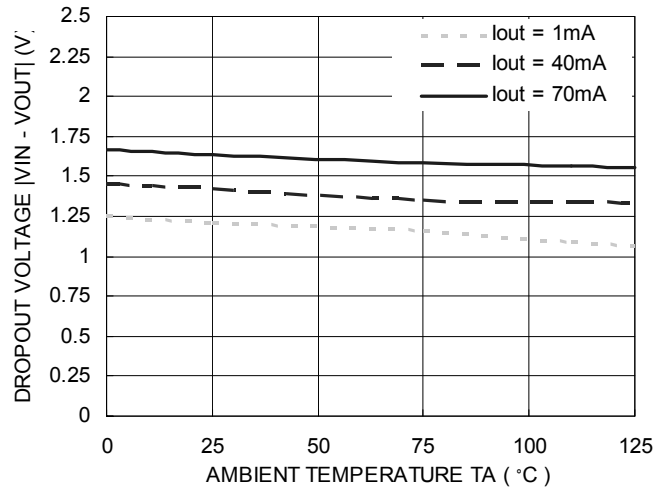

Dropout Voltage vs. Ambient Temperature

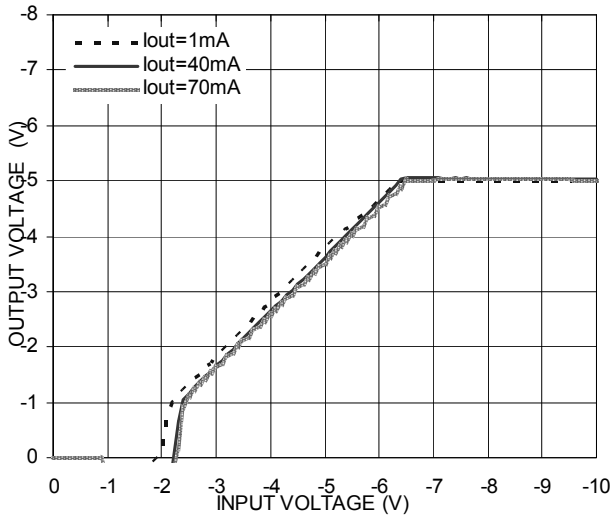

Output Voltage vs. Input Voltage

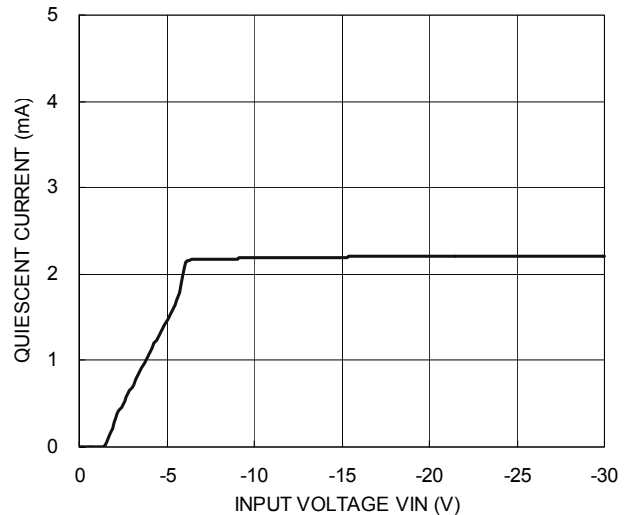

Quiescent Current vs. Input Voltage

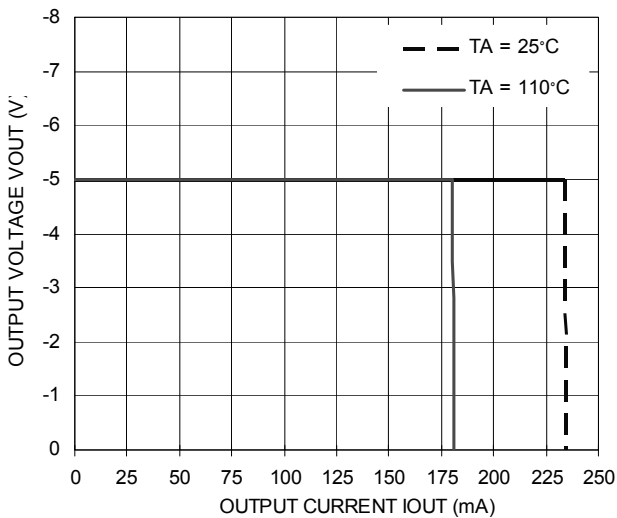

Output Voltage vs. Output Current