

OOK TRANSMITTER

433.92 MHz- 50 Ω OUTPUT

Cod. 32001151V3



DESCRIPTION:

Ultra - compact SAW Resonator - stabilized OOK transmitter, manufactured in SMT technology on printed circuit board. A "buffer" stage separates output from oscillator ensuring higher stability and low harmonic emissions.

HIGHLIGHTS:

TTL and CMOS levels compatible input.
Very compact and low profile.
Developed according to ETSI 300 220 and ETS 300 683 European Standards.

APPLICATIONS:

Security Systems, Surveillance Systems, Data Transmission, etc.

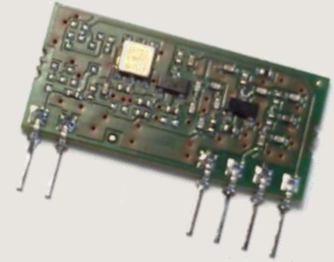

MECHANICAL CHARACTERISTICS

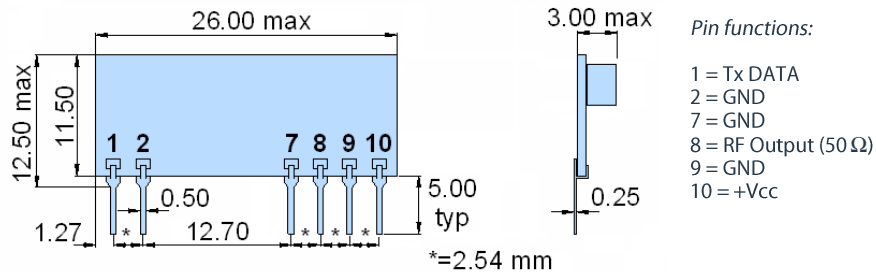

ABS. MAX. RATINGS

Supply Voltage, +Vcc, pin 10:	+ 5 Volt
Voltage, with respect to GND, of pin 1:	+ Vcc
Storage Temperature:	- 40 ÷ + 100 °C
Operating Temperature:	- 20 ÷ + 70 °C

ELECTRICAL CHARACTERISTICS AT + 25 °C TEMPERATURE

Parameter	Min.	Typ.	Max.	Unit	Notes
Supply Voltage (Vcc)	2.1	3.0	3.6	Volt	
Current consumption	-	6	-	mA	Note 1
Operating frequency	-	433.92	-	MHz	
Frequency accuracy	-	±100	-	kHz	
Output power (50 Ohm load)	-	10	-	dBm	Note 1/2
Input Logic low	-0.7	-	0.4	Volt	
Input Logic high	0.9 * Vcc	-	1.1 * Vcc	Volt	
Baud rate	-	-	9600	Baud	

MIPOT S.P.A.

Via Corona, n.5
(Zona Ind.)
34071 Cormons (GO)
Italy
Tel.+39 0481 630200 ra.
Fax +39 0481 62387
mipot@mipot.com

TYPICAL CHARACTERISTICS (*)

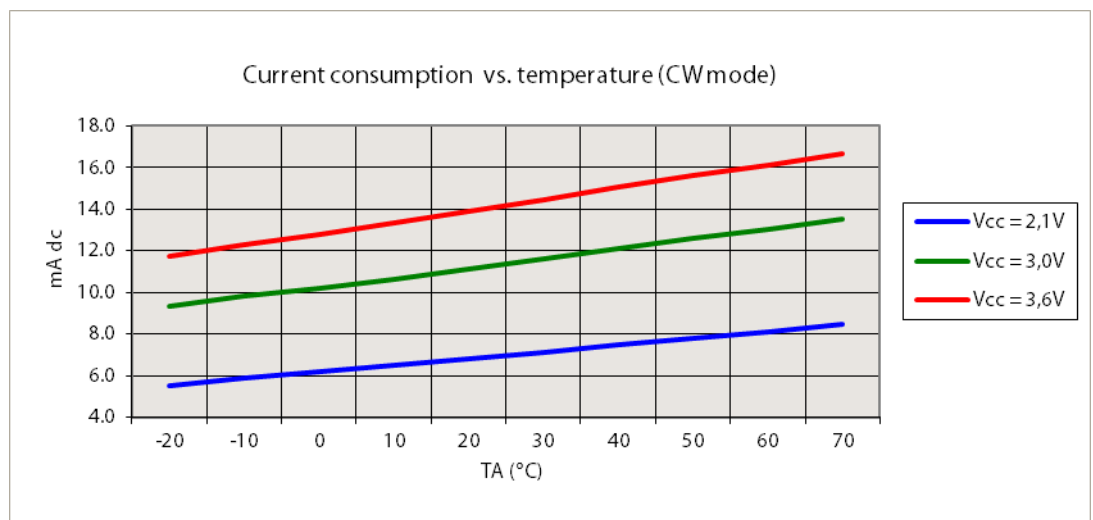
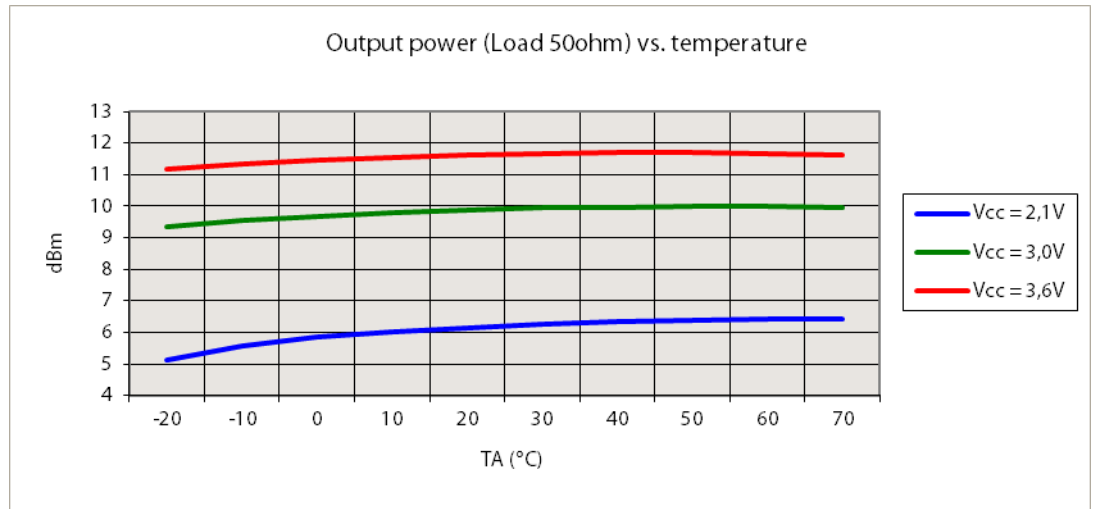

(*): All graphs must be considered as indicative typical results in accordance with temperature variation.

Note 1: +Vcc = 3V, 1.2 kHz square wave modulation 0-3 V, duty-cycle 50%, logic "1" = 3 V.

Note 2: the output power is dependent upon logic "1" level.

APPLICATION NOTE

To ensure the declared frequency accuracy it is necessary that the logic level of the input data remains within the range indicated in the paragraph "ELECTRICAL CHARACTERISTICS AT + 25 °C TEMPERATURE".

MIPOT S.P.A.

Via Corona, n.5

(Zona Ind.)

34071 Cormons (GO)

Italy

Tel.+39 0481 630200 ra.

Fax +39 0481 62387

mipot@mipot.com

GUIDELINES FOR CORRECT POWER SUPPLY AND GROUND PLANE LAYOUT DESIGN IN TRANSMITTING APPLICATIONS

In developing applications that use Mipot Transmitter Modules, care must be taken in designing the layout of the ground plane and power supply paths with particular attention to some general rules as described in the following sections.

Below is a typical layout of the solder side of a PCB suited for a transmitter, including pin-out numbering:

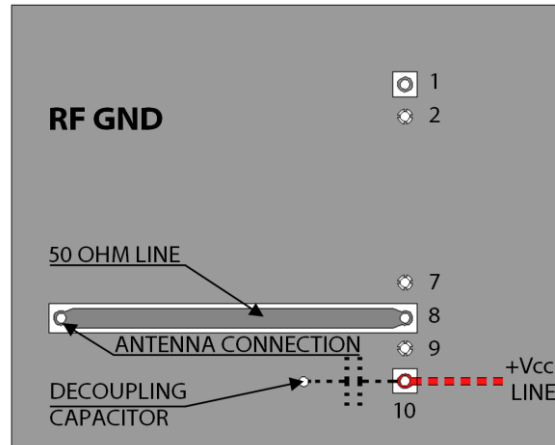

Note: Dotted elements must be placed on component side (PCB side opposite to ground layer).

Note: This is a general layout, in some modules it could have different pin position.

Ground Layer:

- Must be present around the antenna output area;
- Must cover all the area around the transmitter module;
- Circuit should be realized on two side PCB, connecting both sides with pass-through far at least 15 mm each other.

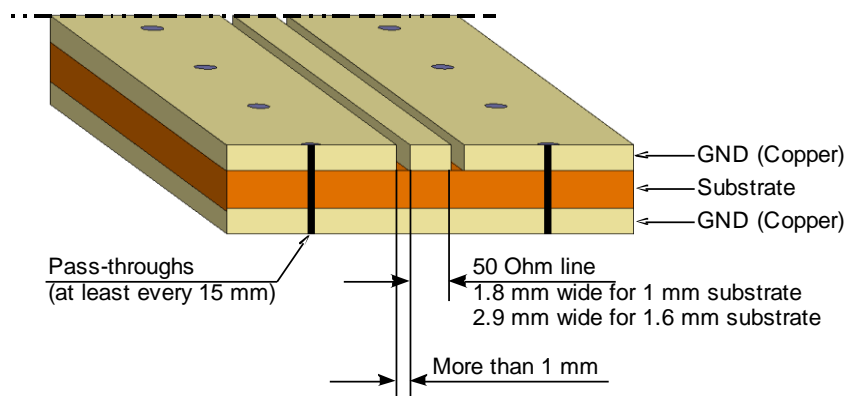

Note: the dimensions in the picture above are referred to a FR4 substrate PCB

Supply Path:

- Needs a good filtered DC component;
- Place decoupling ceramic capacitors directly on supply pin(s), taking care to use different capacitance values at different pins (10 to 1000nF).

Antenna line:

- Should be kept as short as possible in order to reduce losses.

MIPOT S.P.A.

Via Corona, n.5
(Zona Ind.)
34071 Cormons (GO)
Italy
Tel.+39 0481 630200 ra.
Fax +39 0481 62387
mipot@mipot.com

Another fundamental issue when dealing with supply paths is to ensure a good decoupling between Digital, RF and Power circuitry.

Below is the recommended Power Supply Path structure to be followed:

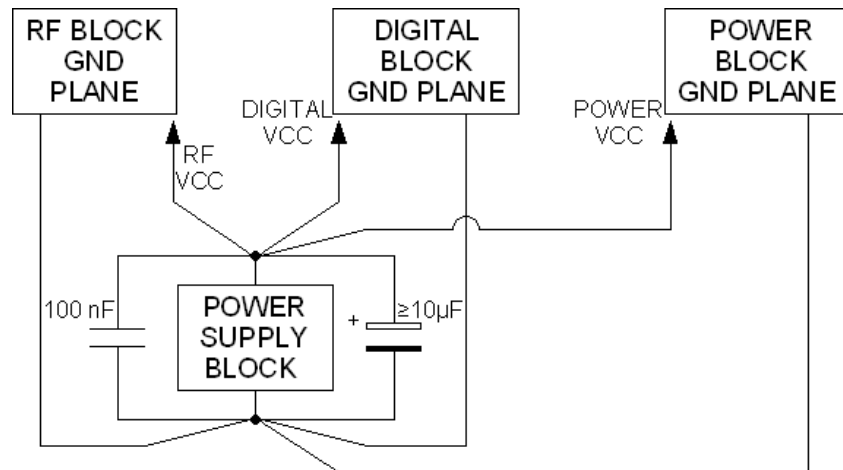

Keep separate paths for:

- RF block;
- Digital block;
- Power block.

HINTS FOR ANTENNA SELECTION

A good antenna design is required to achieve the maximum performances from Mipot modules and obtain the required range.

The recommended antenna is a **Quarter-Wave Monopole Antenna** positioned vertically on a ground plane having a radius $R \geq L$ (where L is the antenna length corresponding to $\frac{1}{4}$ wave length), in an area that has to be kept free from other components and metallic objects.



The antenna length can be quickly determined as $L[\text{cm}] = 7500 / \text{Frequency}[\text{MHz}]$. Typical length for a quarter wave antenna operating at 434MHz is 17cm (6.7 inch), for a frequency of 868MHz the length will be 8.6 cm (3.4 inch), bearing aware that some corrections will be necessary in depending upon the thickness, the material, the eventual coating etc., in order to obtain a correctly tuned device. It is also to be noticed that using a planar ground the antenna impedance is approximately equal to 350ohm (i.e. $\frac{1}{2}$ impedance of a dipole), so a matching network will be useful to improve the efficiency.

Example of $\lambda/4$ antenna for 868MHz

If this type of antenna is not usable (e.g. in portable devices) other solutions are obviously possible, keeping in mind that antenna design varies depending on the specific application, the materials used, the layout structure and the size of the ground plane, so a *specific design* is recommended to get the maximum performance.

In designing antennas it is useful to follow some general considerations:

- keep the area near the antenna as free as possible from other components and metallic objects
- avoid tracks and ground planes near the area of the antenna
- where possible use a large ground plane having a radius $R \geq L$, where L is the antenna length, placing the antenna in the center
- ensure good electrical connections of the ground layer
- use 50 Ohm coax cable with low insertion loss if long connections are used.

An alternative to an antenna specific design is the use of some commonly used antenna solutions which can give satisfactory results if correctly chosen and dimensioned:

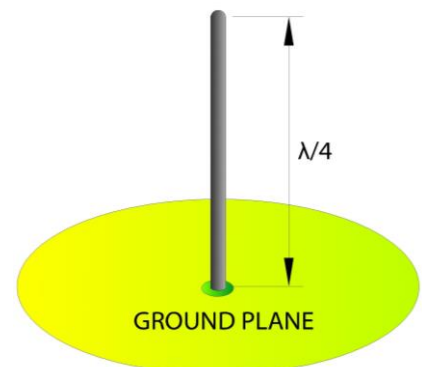

MIPOT S.P.A.

Via Corona, n.5
(Zona Ind.)
34071 Cormons (GO)
Italy
Tel.+39 0481 630200 ra.
Fax +39 0481 62387
mipot@mipot.com

- **PCB trace antenna:**
If the size of the device allows, it should be also a quarter-wave antenna. Shorter antennas implicate a loss of efficiency and a poor range. Trace length could be 10% to 20% shorter than the theoretical value, depending on the dielectric and the thickness of the PCB. If the device is to be handheld, the antenna could be even shorter, to compensate the effect of human body.

- **Helical antenna:**

This is typically a coil which is wound with copper, phosphor bronze or steel wire, with an open end and the other connected to the RF device. The number of turns is depending upon coil diameter, spacing of the turns and diameter of the wire, so it can be determined by winding a coil with a great number of turns and reducing them by cutting until it is tuned at the operating frequency. Fine tuning can be achieved by spreading or compressing the coil. If the coil is wound tightly enough, it may be shorter than one-tenth of a wavelength.

Thanks to its high Q factor, this antenna has typically a narrow bandwidth, and the spacing of the turns has great influence on the performance. For this reasons it can be easily de-tuned by nearby objects, including human body, so it might not be suitable for handheld devices.

This antenna must have a good ground plane, and its performance is very sensitive to antenna position with respect to the ground plane. It is also preferable not to have a long transmission line interposed between the antenna and receiver, but connect it as close as possible to the RF device.

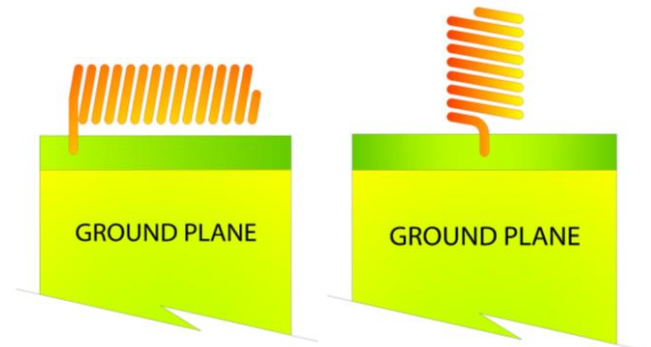

- **PCB Loop antenna:**

This is typically a PCB track with one end tied to ground and the other end connected to the RF device via a tuning circuit (e. g. pi-network) whose scope is to tune and match the low real part impedance antenna to the 50 Ohm TX/RX device output.

It is the least efficient antenna, having an efficiency loss of at least 15-20dB with respect to the quarter wave antenna, but has the advantage that it is not easily detuned by hand effects, so it is often used in handheld transmitters.

Since it has very low gain and a narrow bandwidth, the loop should not have a too small radius to avoid poorer efficiency performance and care should be taken in tuning through the matching network.

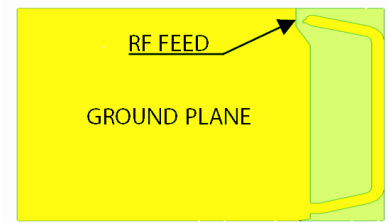

PCB loop antenna

MIPOT S.P.A.

Via Corona, n.5
(Zona Ind.)
34071 Cormons (GO)
Italy
Tel.+39 0481 630200 ra.
Fax +39 0481 62387
mipot@mipot.com