

## DETAILS

<b>Product Number</b>	FA11904_TINA3-WWW
<b>Family</b>	Tina3
<b>Type</b>	Assembly
<b>Color</b>	white
<b>Diameter</b>	16,1 mm
<b>Height</b>	7 mm
<b>Style</b>	round
<b>Optic Material</b>	PMMA
<b>Holder Material</b>	
<b>Fastening</b>	tape, pin
<b>Status</b>	production ready
<b>ROHS Compliant</b>	Yes
<b>Date Updated</b>	13/09/2013



## OPTICAL PROPERTIES

LED	Viewing	Light	Effi-	cd/lm	Connector
	Angle	Beam	ciency		
XM-L	70 deg	WWW-class	89 %	0.600	-
XM-L HVW	sim: 80	WWW-class	84 %	-	-
XT-E	60 deg	WWW-class	88 %	0.800	-
XM-L2	71 deg	WWW-class	88 %	0.700	-
XP-G2	67 deg	WWW-class	90 %	0.700	-
XP-L	65 deg	WWW-class	89 %	0.670	-
XP-L HI	67 deg	WWW-class	90 %	0.750	-
NS9x383	72 deg	WWW-class	87 %	0.600	-
Z5M1/Z5M2	65 deg	WWW-class	89 %	0.730	-

# Absolute intensity of FA11904\_TINA3-WWW (Cree XT-E)

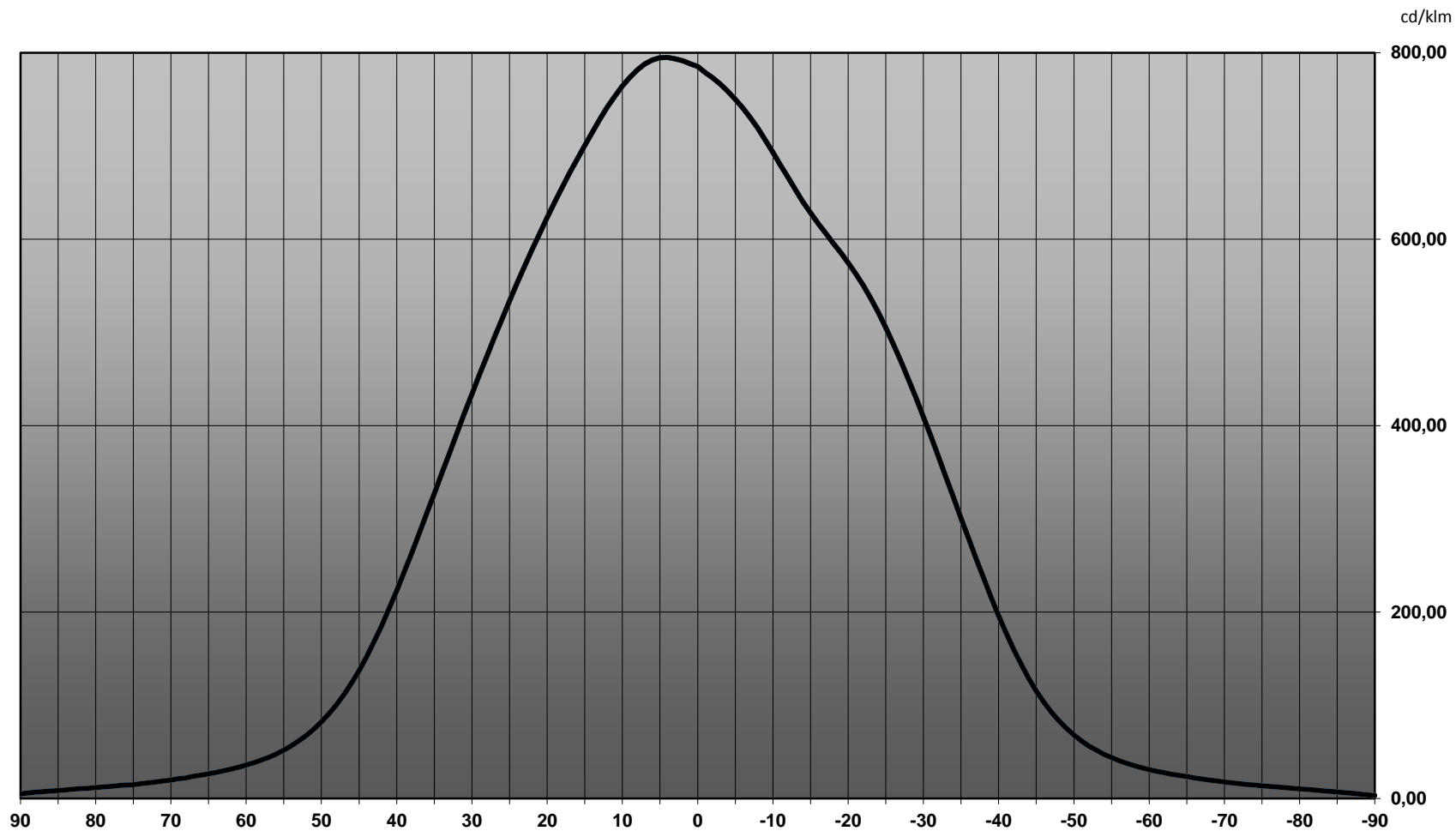

Relative intensity of FA11904\_TINA3-WWW\_(XM-L2)

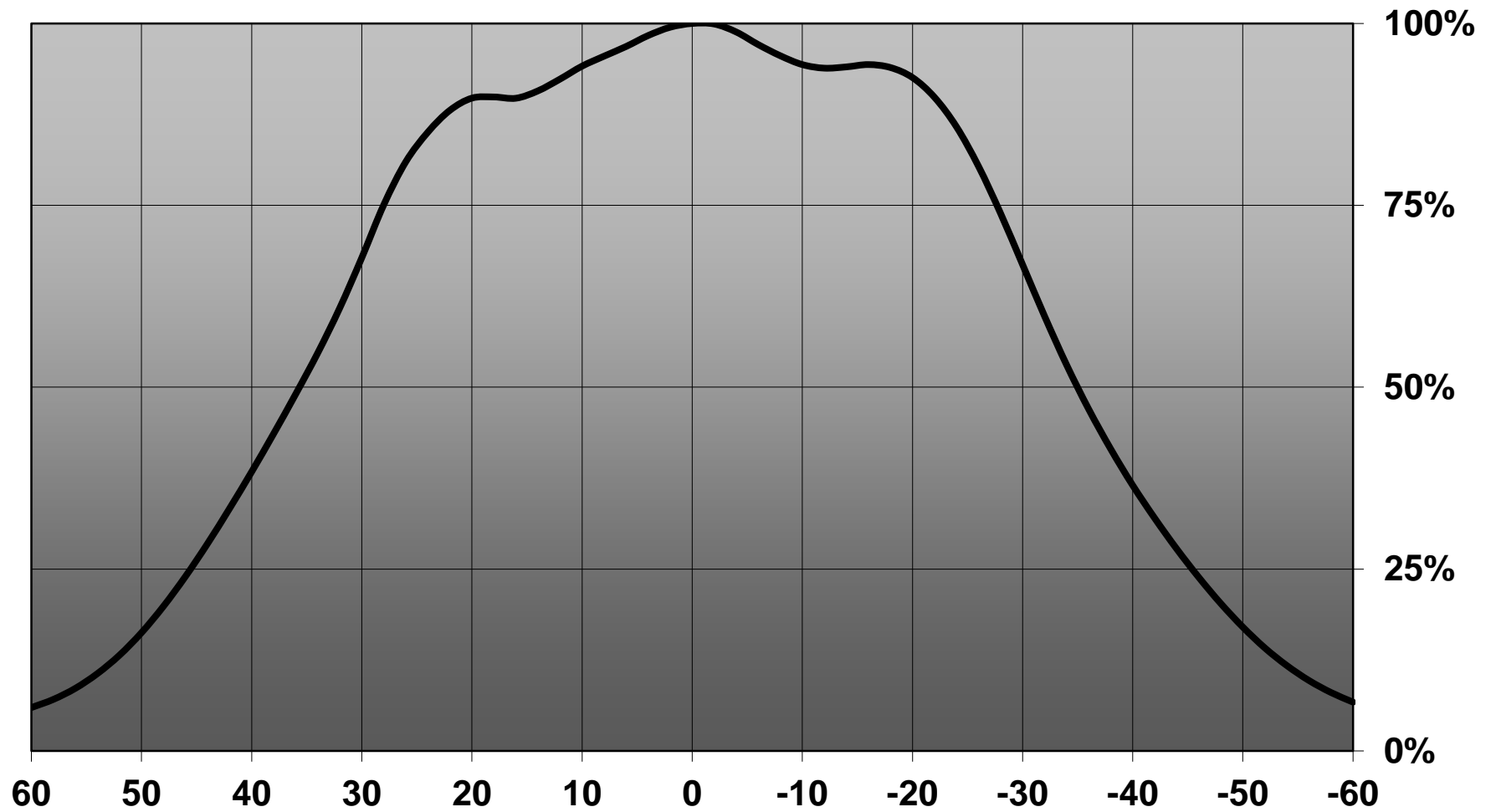

D

C

B

A

4

4

LED position

8.6  
C/C

Ø 16

Ø 2

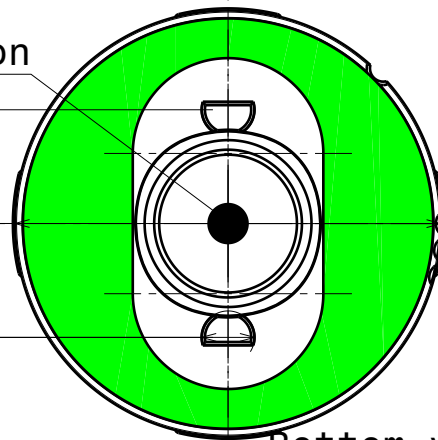

Bottom view  
Scale: 7:2

3

3

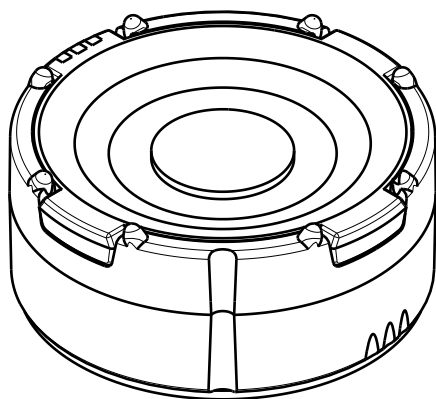

Isometric view  
Scale: 7:2

2

2

6.5

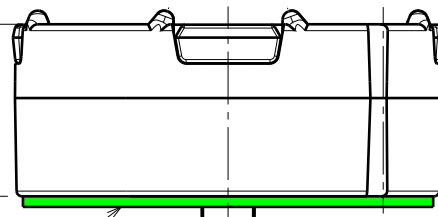

Tape 0.4mm

Front view  
Scale: 7:2

Tolerances if not otherwise shown  
According to DIN ISO 2768-1  
Linear measures:  
Up to 30mm class M, otherwise class C.  
According to DIN ISO 2768-2  
Form and position: class L

LEDiL

Ledil Oy  
Salorankatu 10  
FIN 24240 SALO  
Finland

THIRD ANGLE PROJECTION:

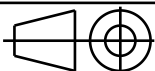

DRAWING TITLE

FA11904\_TINA3-WWW

This drawing is the property  
of LEDiL Oy. It may not be  
reproduced, copied or  
communicated without a written  
agreement with LEDiL Oy."

SIZE

PART NUMBER

A4

FA11904

SCALE

7:2

WEIGHT

-

SHEET

1/1

D

A

1

1

Luminaire: Ledil Oy FA11904\_TINA3-WWW (Cree XM-L 90lm @ 250mA) Efficiency=89%  
Lamps: 1 x Cree XM-L 90lm @ 250mA

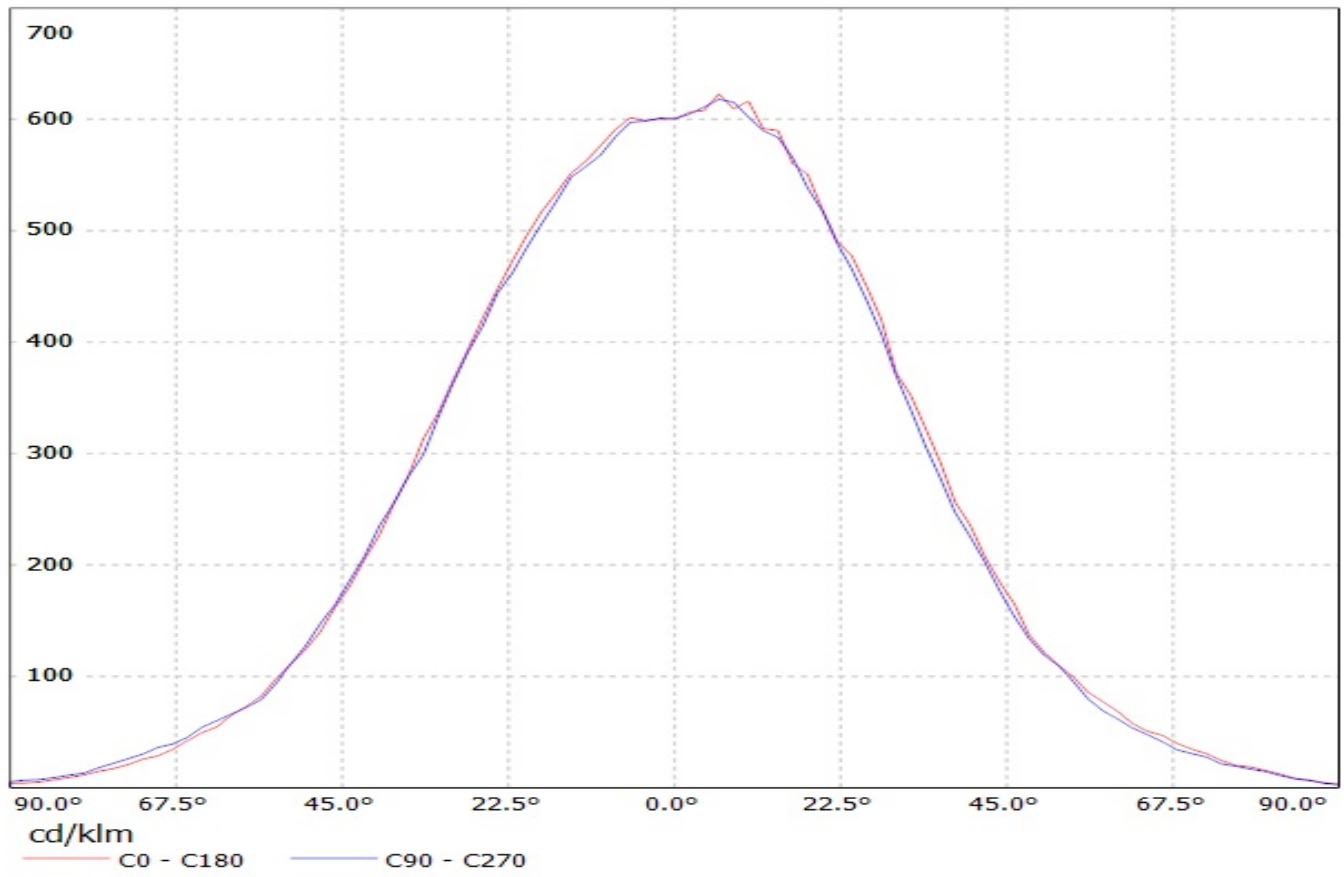

Luminaire: Ledil Oy FA11904\_TINA3-WWW (Cree XM-L2 100lm @ 250mA) Efficiency=90%  
Lamps: 1 x Cree XM-L2 100lm @ 250mA (XMLBWT-0-7B4-T30-0L-0001) CCT= Cool White P=0,75W I=250mA

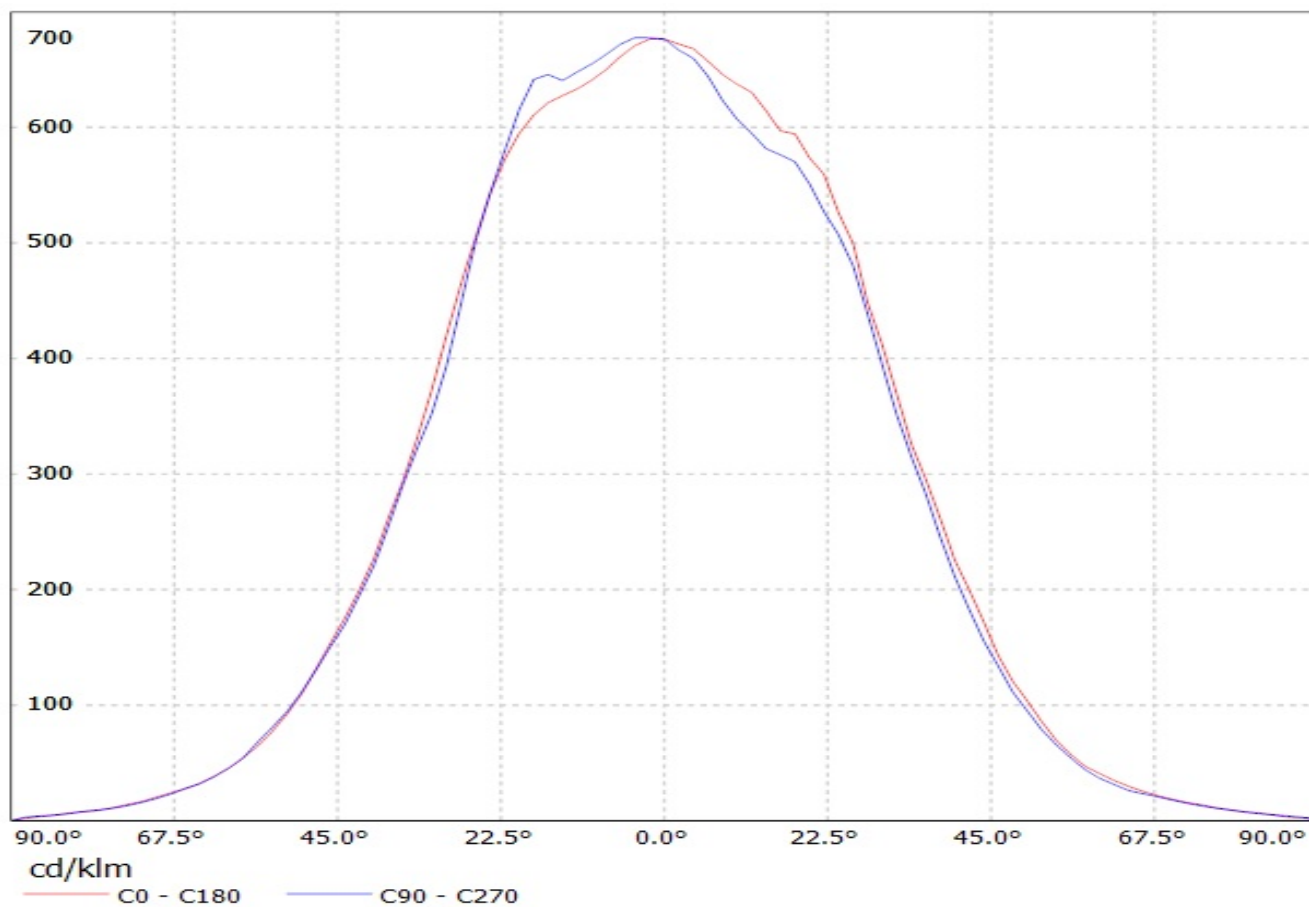

Luminaire: LEDil Oy FA11904\_TINA3-WWW\_(XP-G2) Efficiency=90%  
Lamps: 1 x XP-G2 (XPGBWT-L1-0000-00FE4) 101lm 250mA CCT=6600K P=0.7W I=250mA

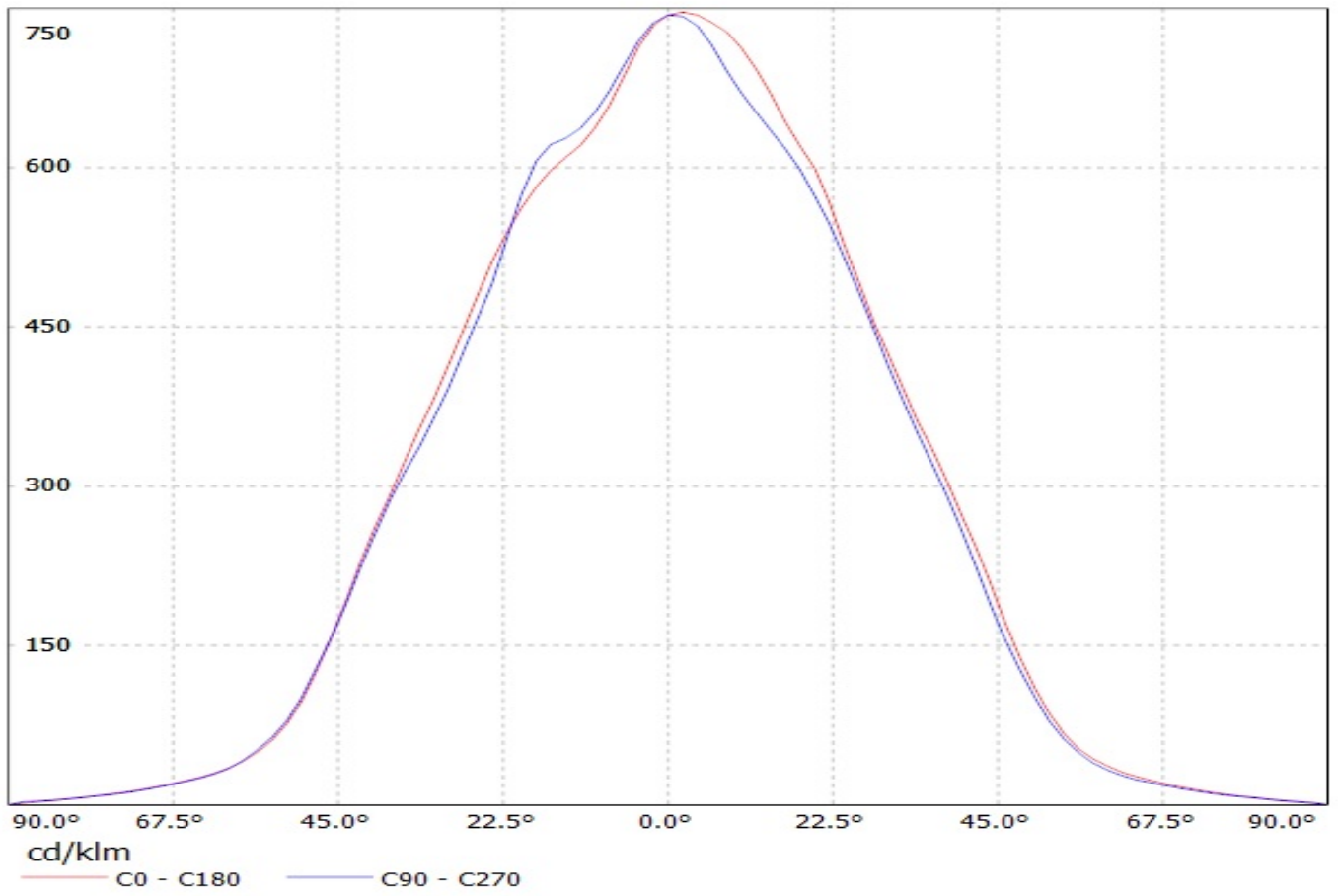

Luminaire: LEDiL Oy FA11904\_TINA3-WWW\_(XP-L) Eff.88.8%  
Lamps: 1 x Cree\_XP-L\_127.813lm@250mA\_P=0.73723W\_I=249.9mA

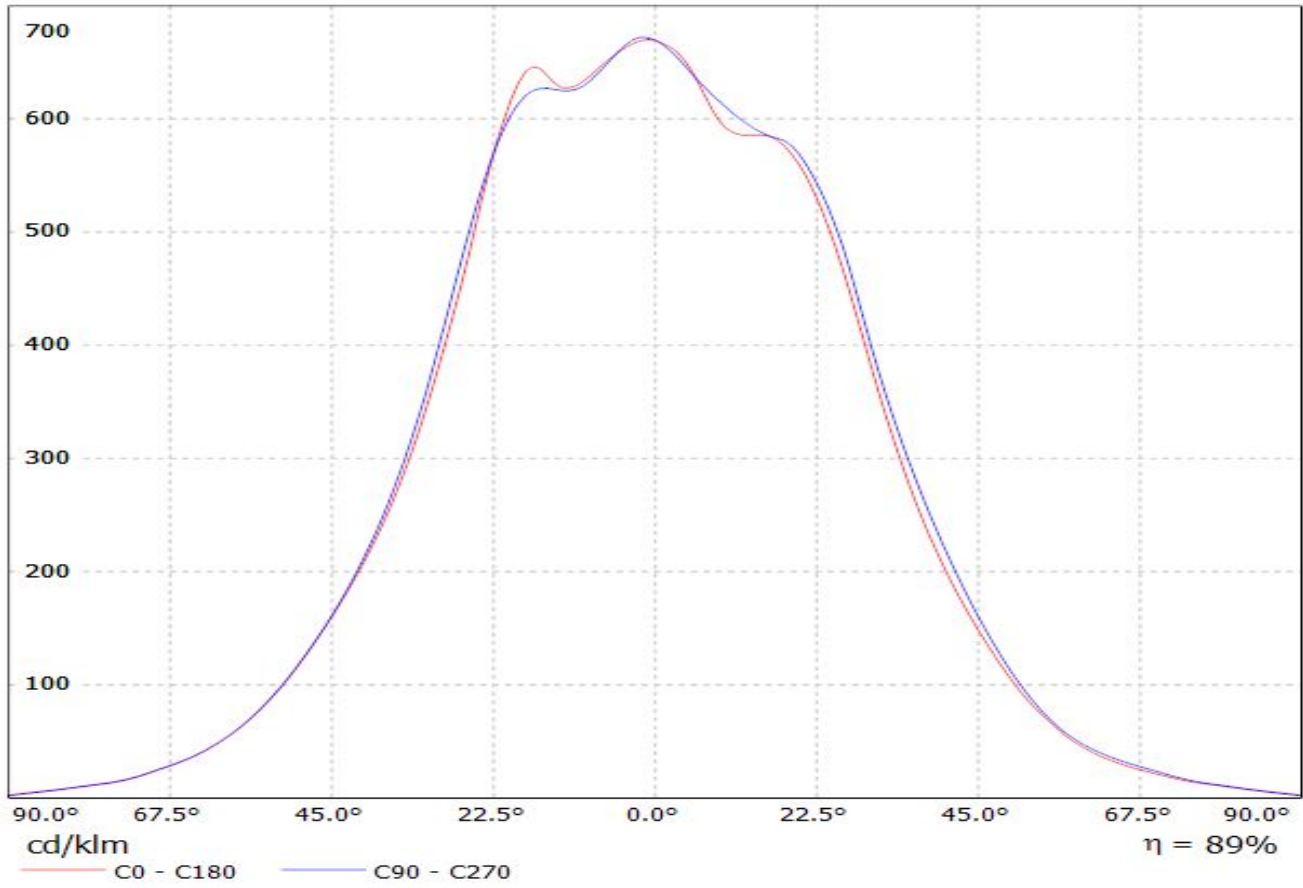





Luminaire: LEDiL Oy FA11904\_TINA3-WWW\_(NS9x383) Eff. 87%  
Lamps: 1 x Nichia NS9x383 (105lm@250mA)

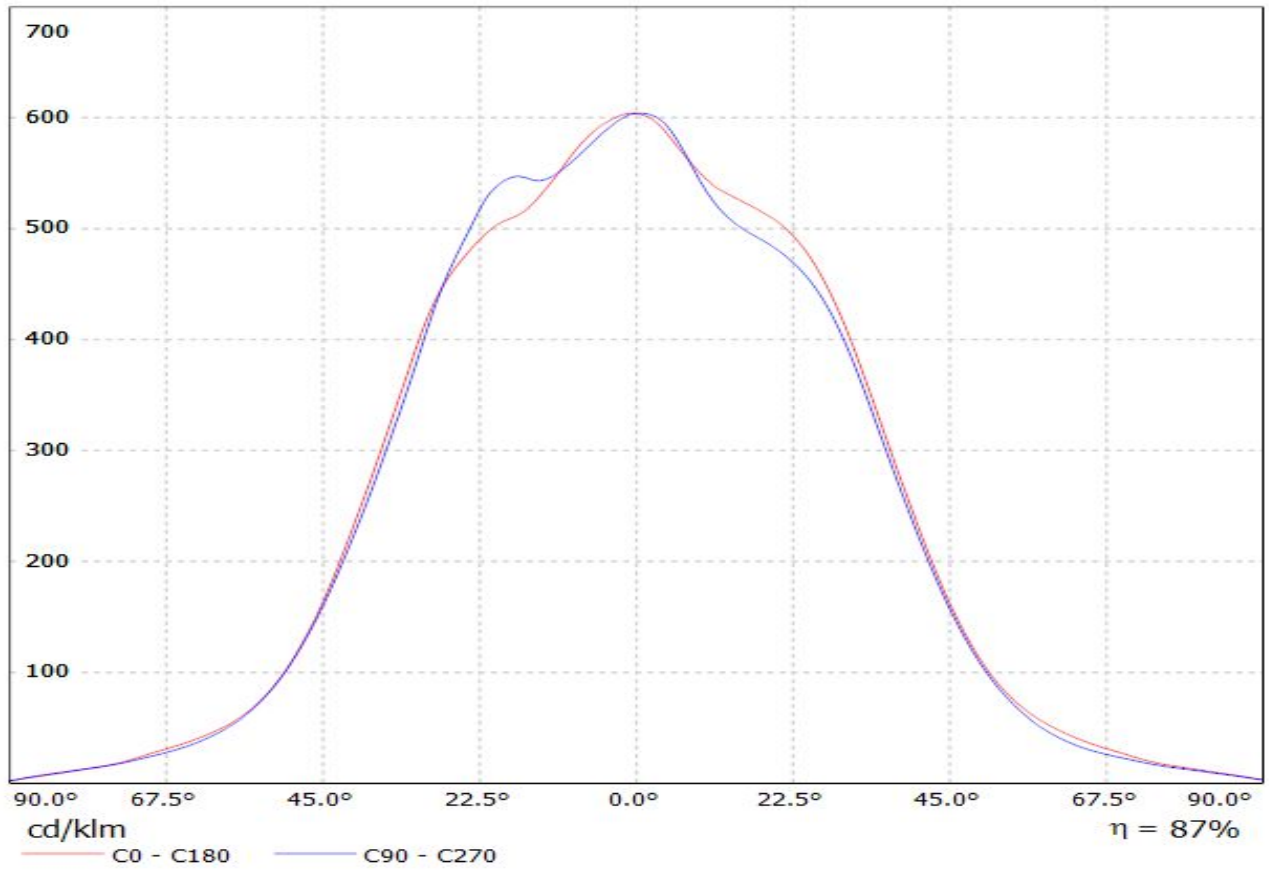

Luminaire: LEDiL Oy FA11094\_TINA3-WWW\_(Z5M1)  
Lamps: 1 x SEOUL Z5M1 SZ5-M1-W0-C8 / W1-A5-G

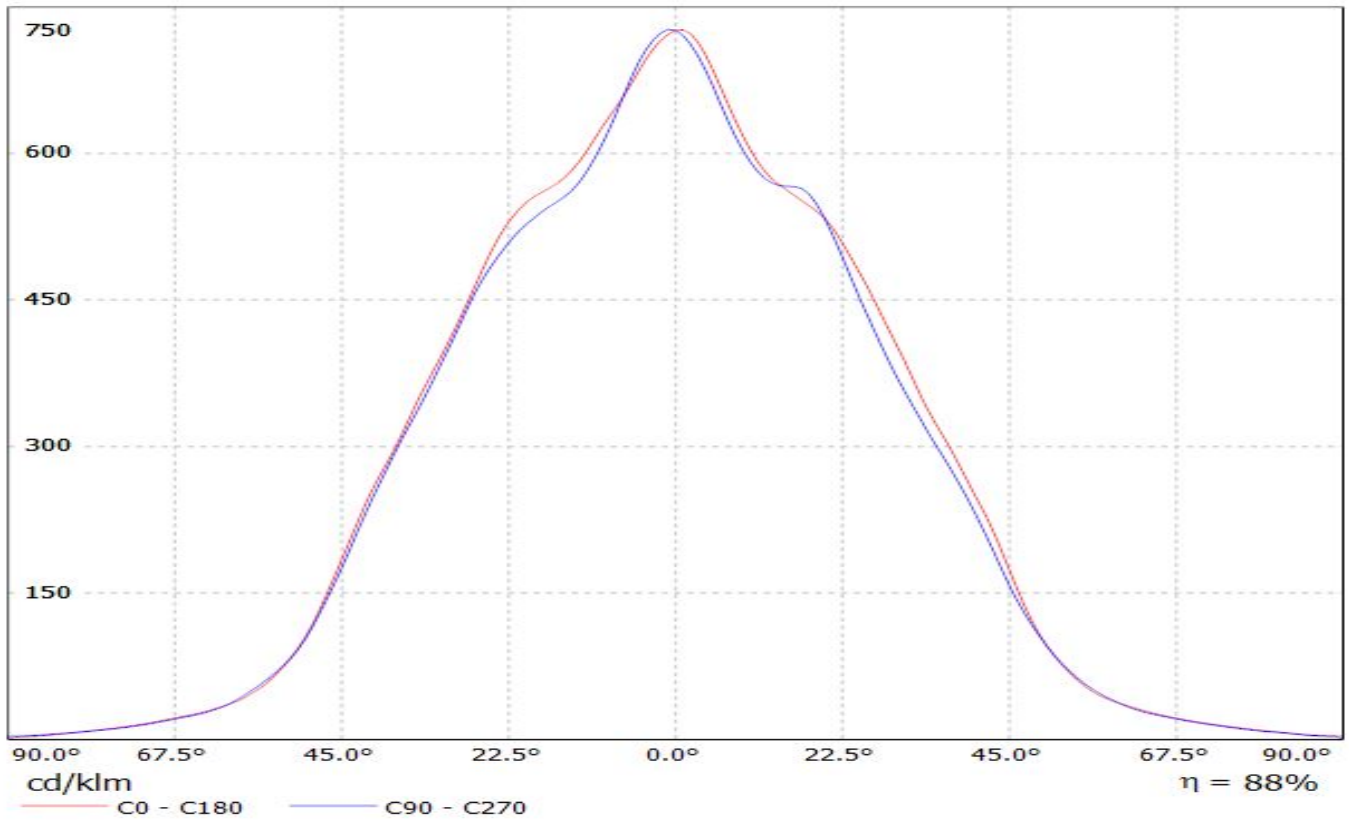

Luminaire: Ledil Oy FA11904\_TINA3-WWW (Cree XM-L 90lm @ 250mA) Efficiency=89%  
Lamps: 1 x Cree XM-L 90lm @ 250mA

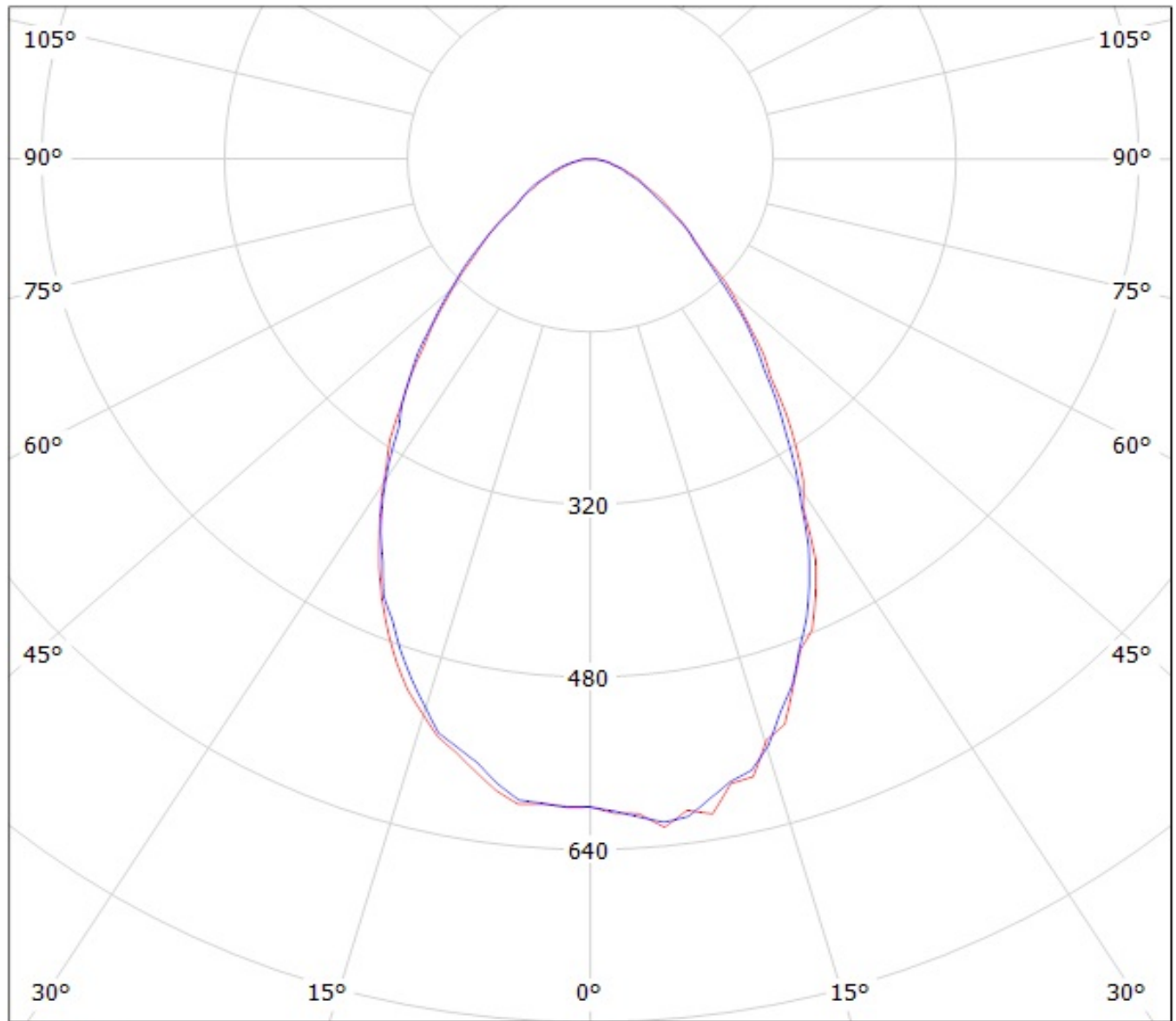

cd/klm

— C0 - C180    — C90 - C270

Luminaire: LEDiL Oy FA11904-Tina3-WWW\_(XT-E) Eff.88.7%  
Lamps: 1 x Cree XT-E (98.7638lm@250mA)

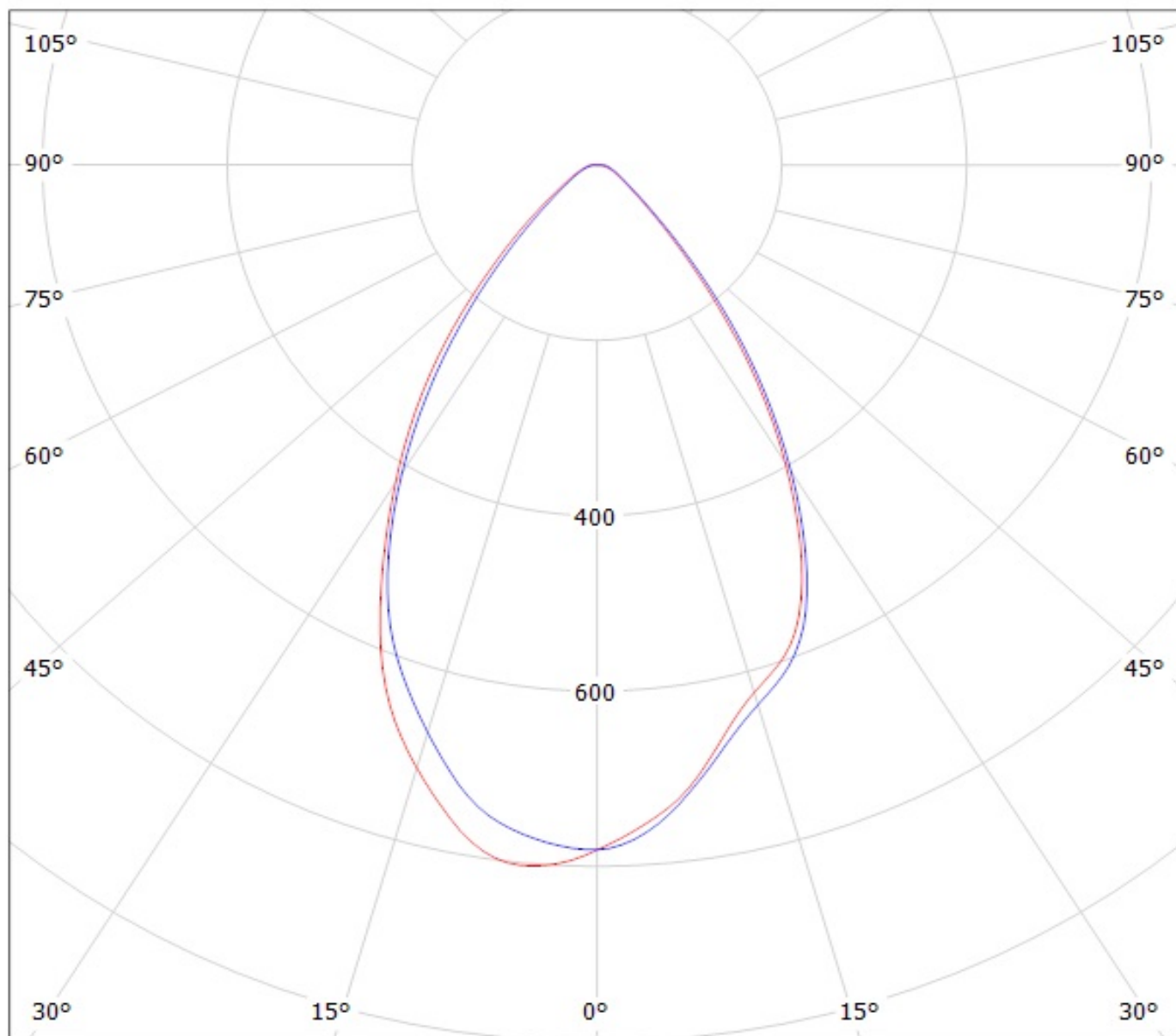

cd/klm

— C0 - C180

— C90 - C270

Luminaire: Ledil Oy FA11904\_TINA3-WWW (Cree XM-L2 100lm @ 250mA) Efficiency=90%  
Lamps: 1 x Cree XM-L2 100lm @ 250mA (XMLBWT-0-7B4-T30-0L-0001) CCT= Cool White P=0,75W I=250mA

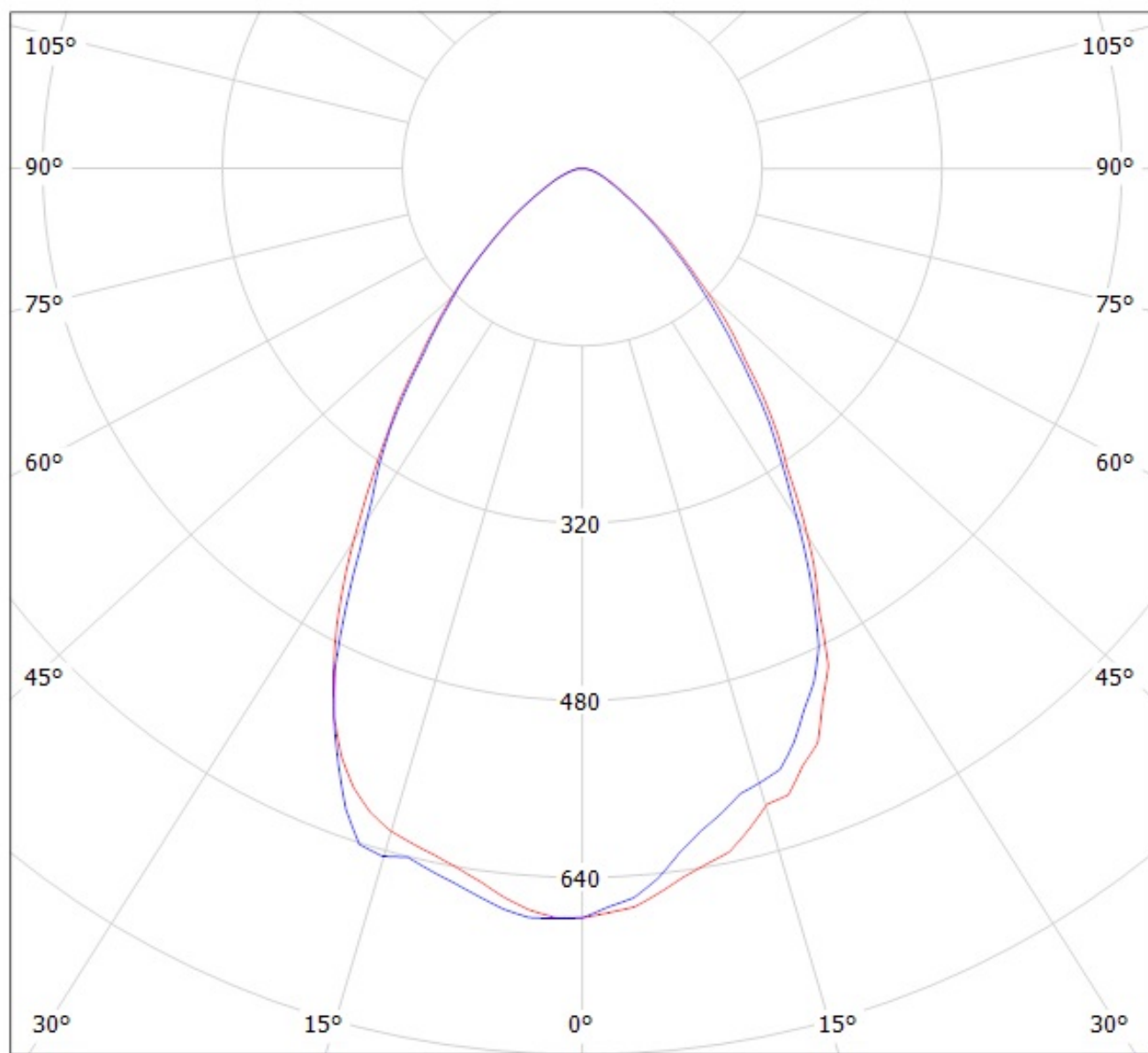

cd/klm

— C0 - C180    — C90 - C270

Luminaire: LEDil Oy FA11904\_TINA3-WWW\_(XP-G2) Efficiency=90%  
Lamps: 1 x XP-G2 (XPGBWT-L1-0000-00FE4) 101lm 250mA CCT=6600K P=0.7W I=250mA

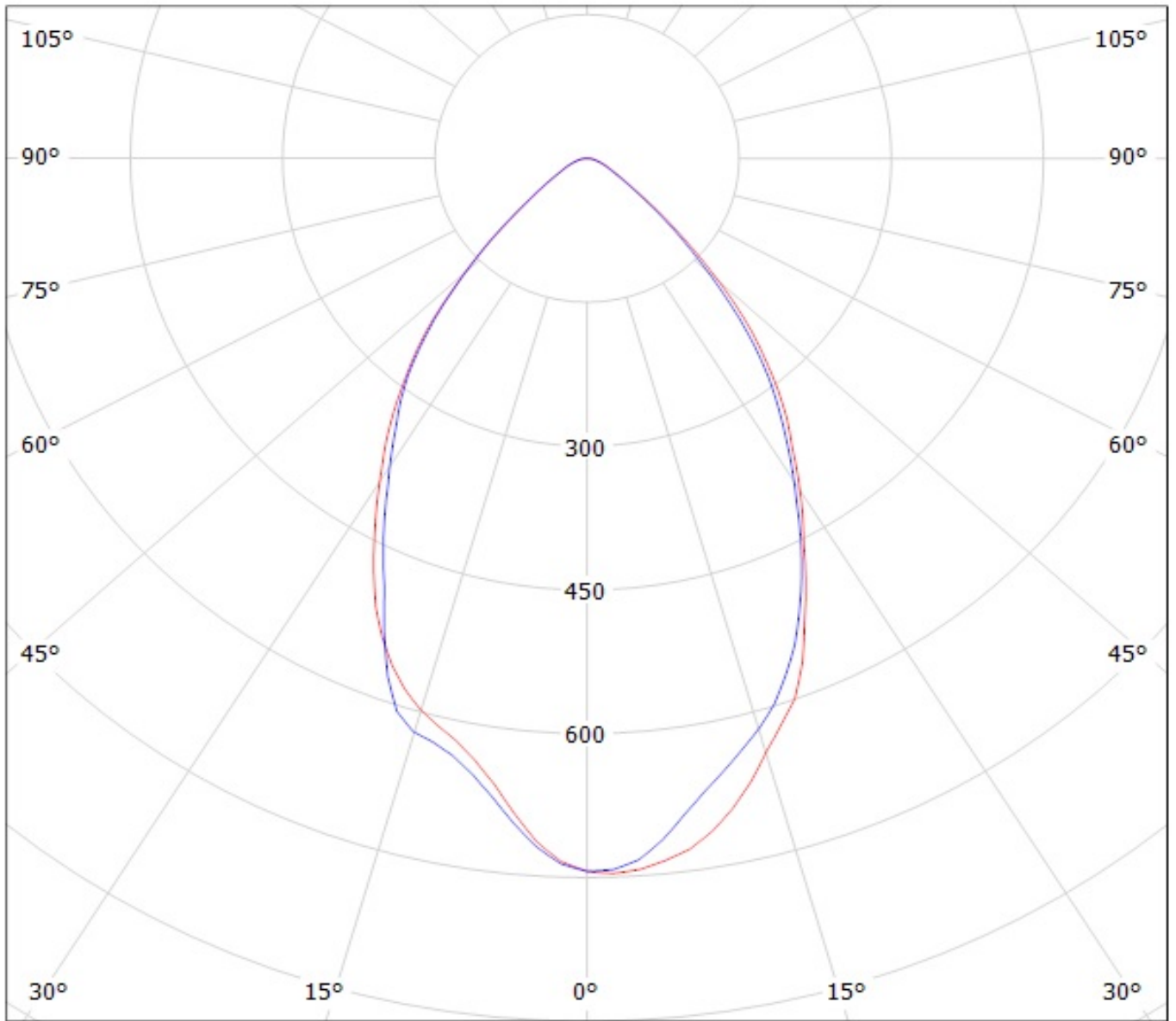

cd/klm

— C0 - C180

— C90 - C270

Luminaire: LEDiL Oy FA11904\_TINA3-WWW\_(XP-L) Eff.88.8%  
Lamps: 1 x Cree\_XP-L\_127.813lm@250mA\_P=0.73723W\_I=249.9mA

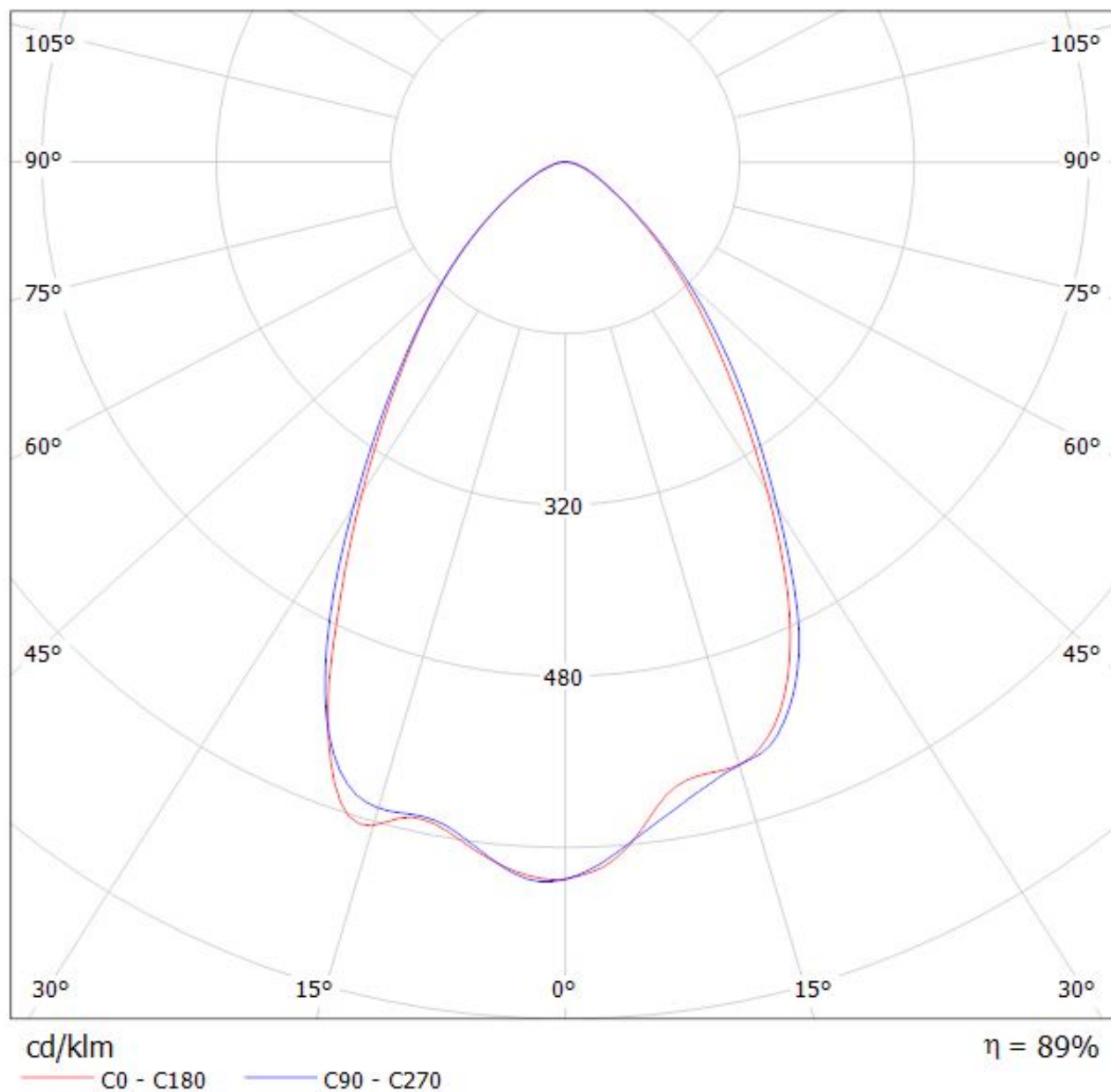



Luminaire: LEDiL Oy FA11904\_TINA3-WWW\_(XP-L\_HI)

Lamps: 1 x Cree\_XP-L\_HI\_113.703lm@250mA\_P=0.743328W\_I=0.2499A

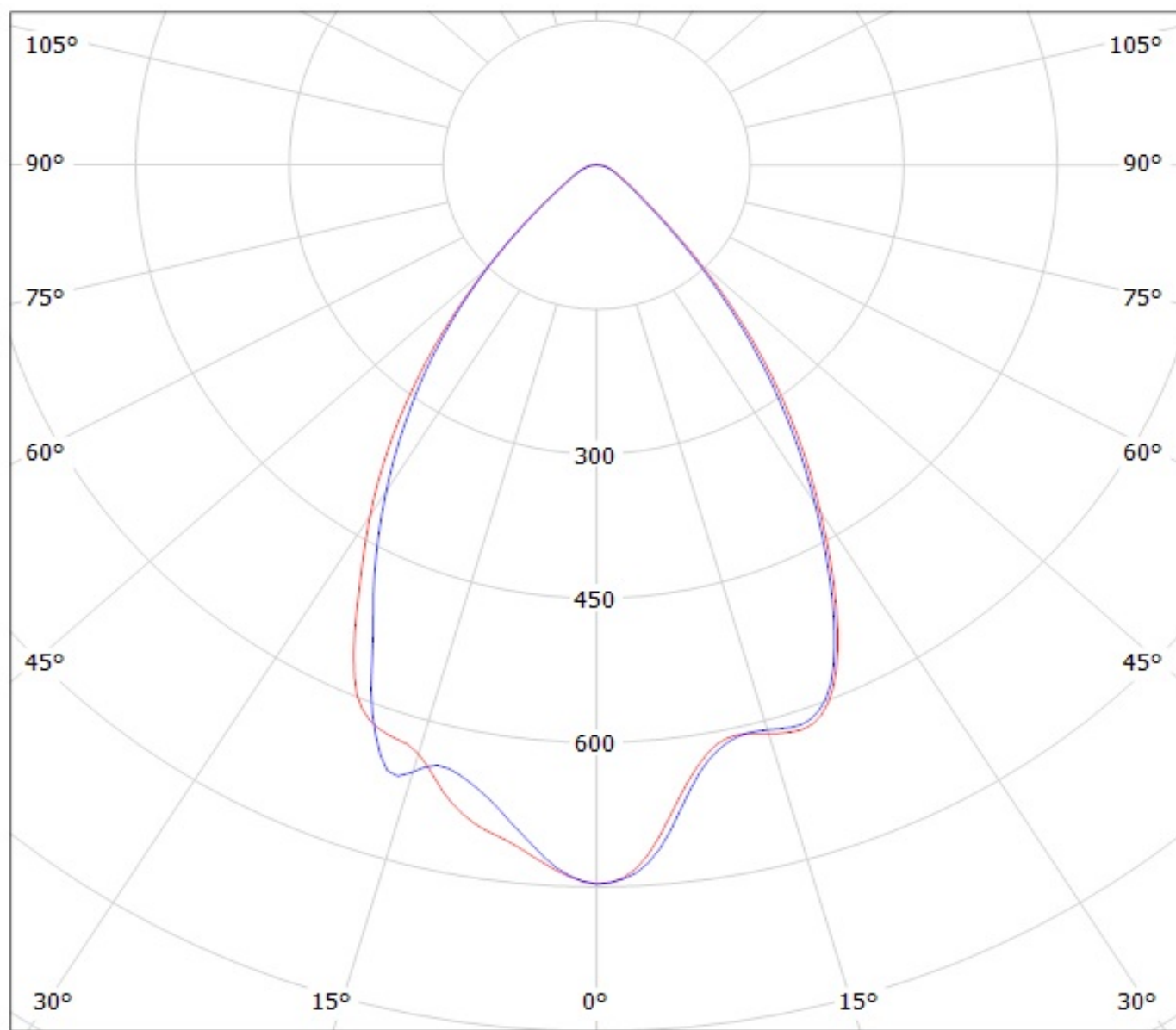

cd/klm

— C0 - C180

— C90 - C270

$\eta = 90\%$

Luminaire: LEDiL Oy FA11904\_TINA3-WWW\_(NS9x383) Eff. 87%  
Lamps: 1 x Nichia NS9x383 (105lm@250mA)

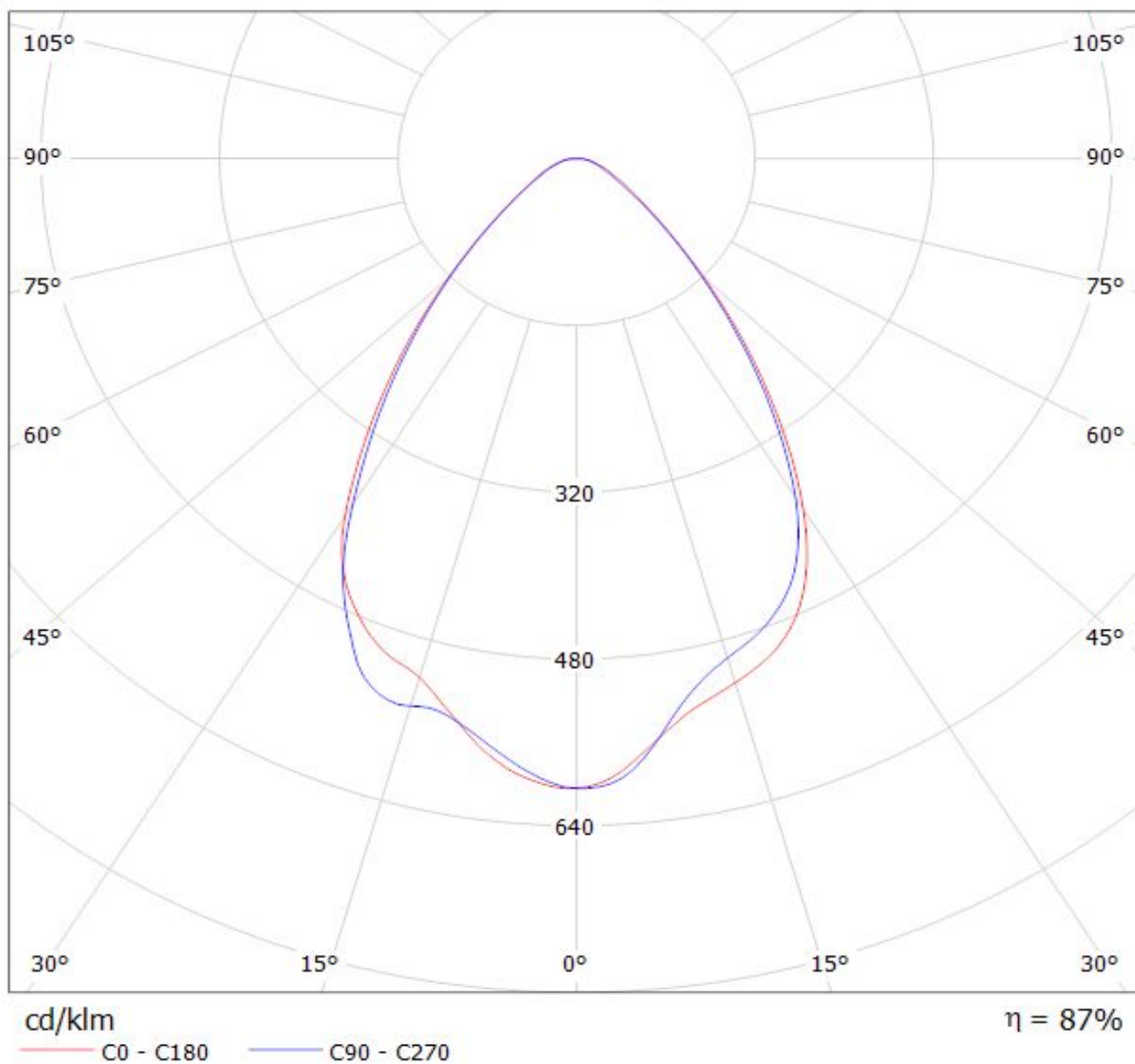

Luminaire: LEDiL Oy FA11094\_TINA3-WWW\_(Z5M1)  
Lamps: 1 x SEOUL Z5M1 SZ5-M1-W0-C8 / W1-A5-G

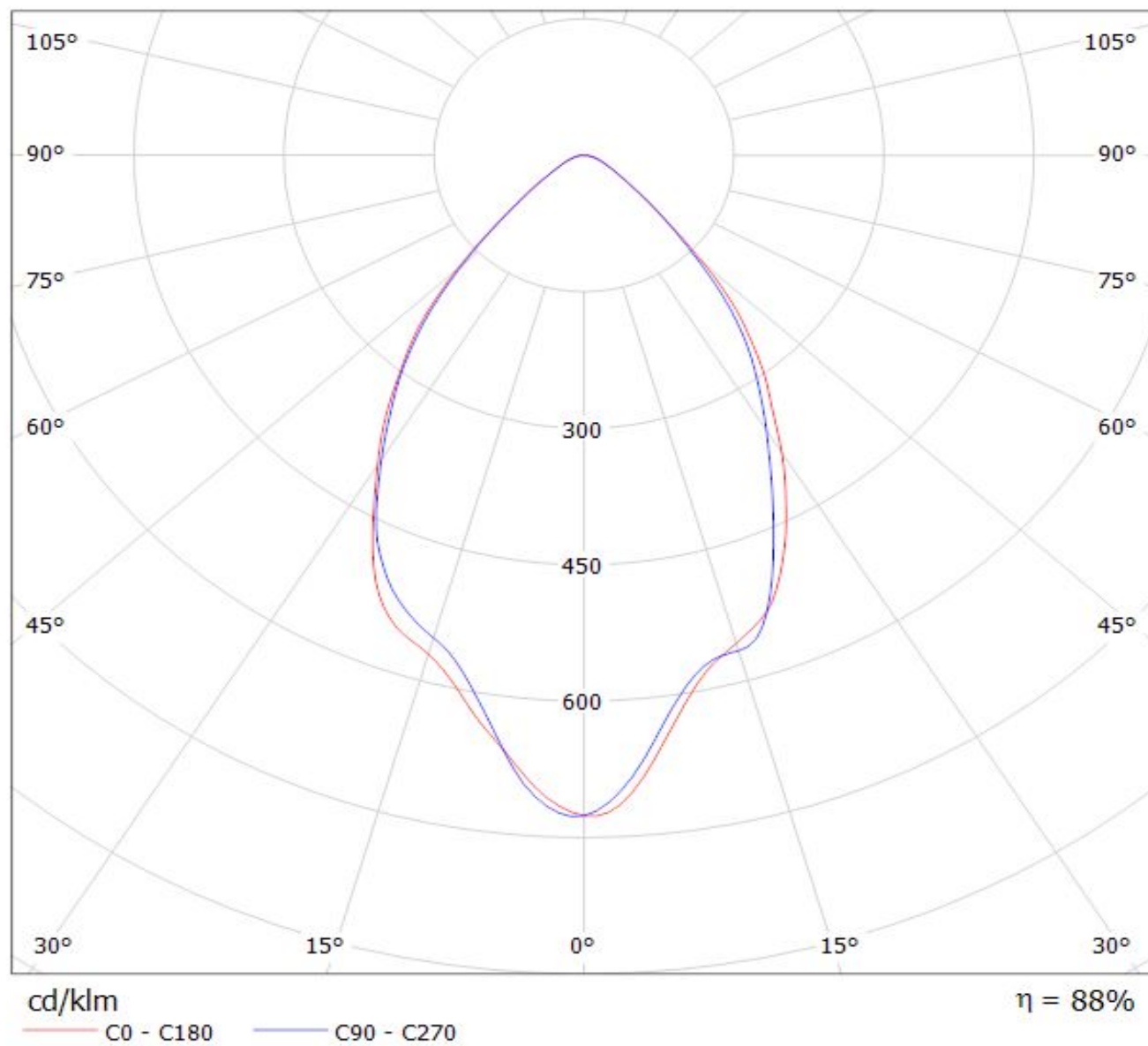

**NOTE: The typical divergence will be changed by different color, chip size and chip position tolerance. The typical total divergence is the full angle measured where the luminous intensity is half of the peak value.**