

# 3-Terminal 100mA Positive Adjustable Regulator

# LM317L

## FEATURES

- Output Current Excess of 100mA
- Output Adjustable Between 1.2V and 37V
- Internal Thermal Overload Protection
- Internal Short-Circuit Current Limiting
- Output Transistor Safe-Area Compensation
- Moisture Sensitivity Level 3

## DESCRIPTION

This monolithic integrated circuit is an adjustable 3-terminal positive voltage regulator designed to supply more than 100mA of load current with an output voltage adjustable over a 1.2 to 37V. It employs internal current limiting, thermal shut-down and safe area compensation.

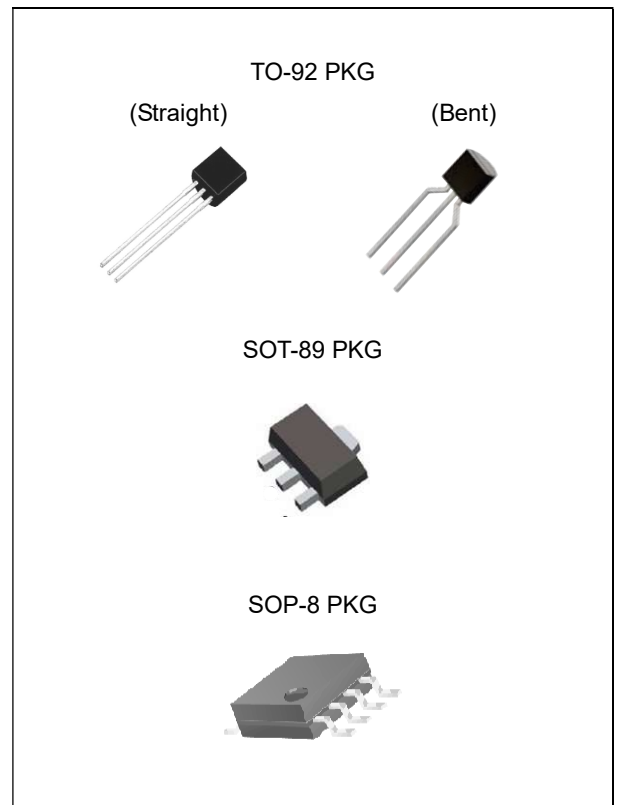

## ORDERING INFORMATION

Device	Package
LM317L	TO-92 (Bulk, Straight)
LM317LTA	TO-92 (Tape, Bent)
LM317LF	SOT-89
LM317LD	SOP-8

## BLOCK DIAGRAM

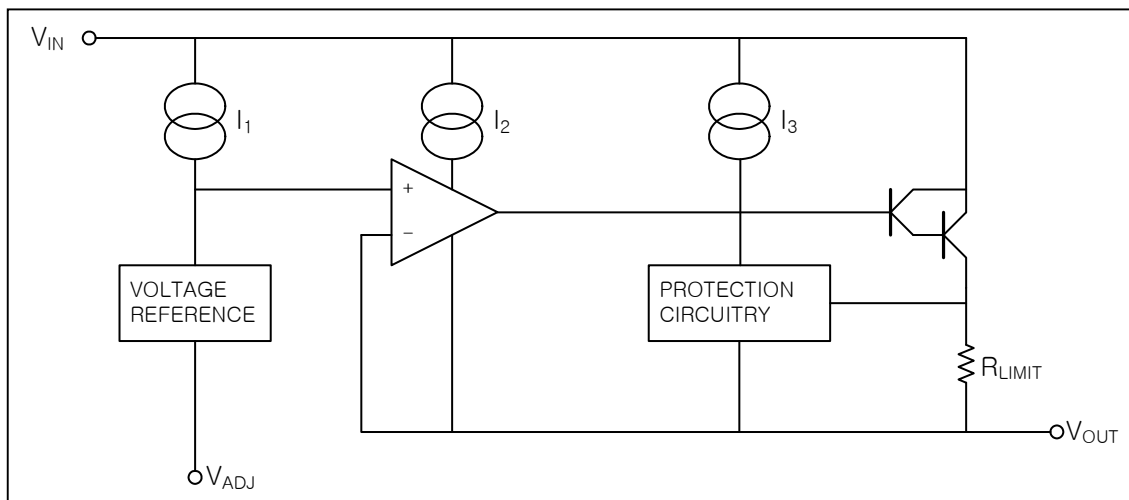

## ABSOLUTE MAXIMUM RATINGS

CHARACTERISTIC	SYMBOL	Value	UNIT
Input-output Voltage Differential	$V_I-V_O$	40	V
Lead Temperature (Soldering, 10 sec)	$T_{SOL}$	230	°C
Power Dissipation	$P_D$	Internally limited	-
Operating Junction Temperature Range	$T_{JOPR}$	-40 ~ 125	°C
Storage Temperature Range	$T_{STG}$	-65 ~ 125	°C

## RECOMMENDED OPERATING RATINGS ( $V_I-V_O=5V$ , $I_O=40mA$ , $-40^\circ C \leq T_J \leq 125^\circ C$ , unless otherwise specified)

CHARACTERISTIC	SYMBOL	TEST CONDITION	MIN.	TYP.	MAX.	Unit	
Line Regulation	$\Delta V_O$	$T_A=-40 \sim 125^\circ C$	$3V \leq V_I-V_O \leq 40V$		0.01	0.04	%/V
			$3V \leq V_I-V_O \leq 40V$		0.02	0.07	%/V
Load Regulation	$\Delta V_O$	$T_A=25^\circ C$ , $10mA \leq I_O \leq I_{MAX}$	$V_O \leq 5V$		10	25	mV
			$V_O \geq 5V$		0.1	0.5	%/V
		$10mA \leq I_O \leq I_{MAX}$	$V_O \leq 5V$		20	80	mV
			$V_O \geq 5V$		0.3	1.7	%/V
Adjustable Pin Current	$I_{ADJ}$			46	100	$\mu A$	
Adjustable Pin Current Change	$\Delta I_{ADJ}$	$3V \leq V_I-V_O \leq 40V$ $10mA \leq I_O \leq I_{MAX}$ $P \leq P_{MAX}$		0.2	5	$\mu A$	
Reference Voltage	$V_{REF}$	$3V \leq V_{IN}-V_{OUT} \leq 40V$ $10mA \leq I_O \leq I_{MAX}$ $P_D \leq P_{MAX}$	1.20	1.25	1.30	V	
Temperature Stability	$ST_T$			0.7		%/V <sub>O</sub>	
Minimum Load Current to Maintain Regulation	$L_{(MIN)}$	$V_I-V_O=40V$		3.5	10	mA	
Maximum Output Current	$I_{O(MAX)}$	$V_I-V_O \leq 5V$ , $P_D \leq P_{MAX}$	100	200		mA	
		$V_I-V_O \leq 40V$ , $P_D \leq P_{MAX}$ , $T_A=25^\circ C$	0.156	0.4			
RMS Noise, % of V <sub>OUT</sub>	$e_N$	$T_A=25^\circ C$ , $10Hz \leq f \leq 10KHz$		0.003	0.01	%/V <sub>O</sub>	
Ripple Rejection	RR	$V_O=10V$ , $f=120Hz$ without $C_{ADJ}$ $C_{ADJ}=10\mu F$		60		dB	
				66	75		
Long-Term Stability, $T_J=T_{HIGH}$	ST	$T_A=25^\circ C$ , for end point measurements, 1000HR		0.3	1	%	

\* Load and line regulation are specified at constant junction temperature. Change in VD due to heating effects must be taken into account separately. Pulse testing with low duty is used.

## ORDERING INFORMATION

PACKAGE	ORDER NO.	DESCRIPTION	SUPPLIED AS	STATUS
TO-92	LM317L	100mA, Adjustable, Positive	Bulk	Active
TO-92	LM317LTA	100mA, Adjustable, Positive	Tape	Active
SOT-89	LM317LF	100mA, Adjustable, Positive	Reel	Active
SOP-8	LM317LD	100mA, Adjustable, Positive	Reel	Active

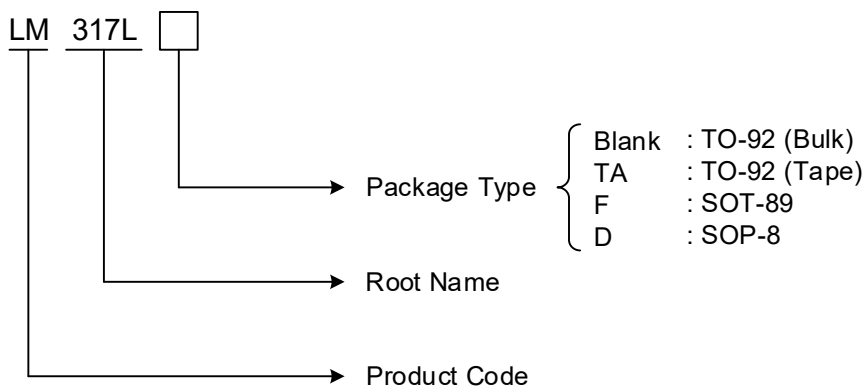

## PIN CONFIGURATION

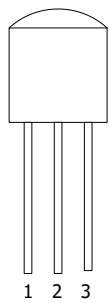

TO-92

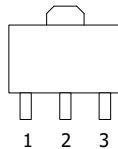

SOT-89

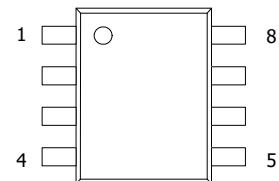

SOP-8

## PIN DESCRIPTION

PIN NO.	TO-92 / SOT-89 3 LEAD		SOP-8 8LEAD	
	NAME	FUNCTION	NAME	FUNCTION
1	ADJ	Adjustable	V <sub>IN</sub>	Input Voltage
2	V <sub>OUT</sub>	Output Voltage	V <sub>OUT</sub>	Output Voltage
3	V <sub>IN</sub>	Input Voltage	V <sub>OUT</sub>	Output Voltage
4	-	-	ADJ	Adjustable
5	-	-	-	N.C.
6	-	-	V <sub>OUT</sub>	Output Voltage
7	-	-	V <sub>OUT</sub>	Output Voltage
8	-	-	-	N.C.

## TYPICAL APPLICATION

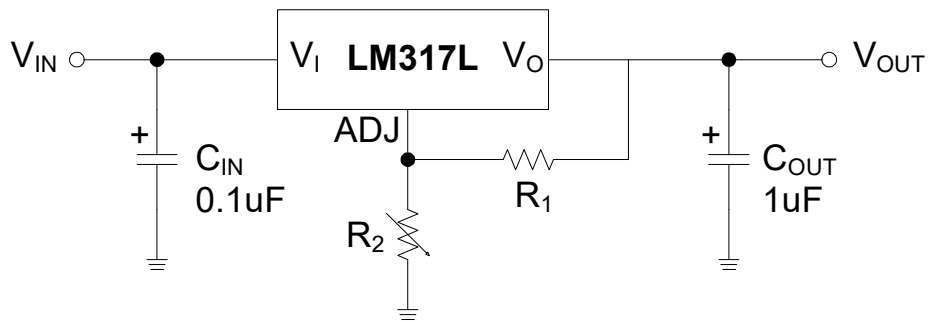

$$V_{OUT} = 1.25V(1+R_2/R_1)+I_{ADJ}R_2$$

Note 1.  $C_{IN}$  is required when regulator is located in appreciable distance from power supply filter.

Note 2.  $C_{OUT}$  is not needed for stability, however, it does improve transient response.

Note 3.  $I_{ADJ}$  is controlled to less than 100uA, the error associated with this term is negligible in most applications.

### REVISION NOTICE

The description in this datasheet is subject to change without any notice to describe its electrical characteristics properly.