



# WSRSIC010065NPM

## SILICON CARBIDE SCHOTTKY DIODE

### Features

- 10A Silicon Carbide Schottky Diode
- Excellent high temperature stability
- Low forward voltage
- High forward surge capability
- 175°C Operating Junction Temperature
- Reduced temperature dependence

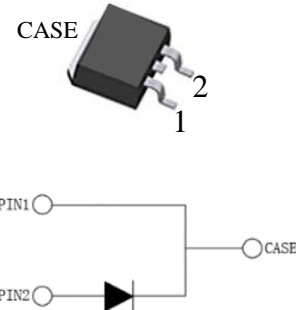

### Mechanical Data

- Case: TO-263-2L

### Absolute Maximum Ratings (T<sub>c</sub>=25°C Unless otherwise specified)

Parameter	Symbol	Value	Unit
Repetitive Peak Reverse Voltage	V <sub>RRM</sub>	650	V
Surge Peak Reverse Voltage	V <sub>RSM</sub>	650	V
DC Blocking Voltage	V <sub>R</sub>	650	V
Maximum Average Forward Rectified Current T <sub>c</sub> =152°C	I <sub>F</sub>	10	A
Surge(Non-Repetitive)Forward Current @ T <sub>p</sub> =10ms Half Sine Wave T <sub>C</sub> =25°C	I <sub>FSM</sub>	80	A
Power Dissipation T <sub>c</sub> =25°C	P <sub>tot</sub>	138	W
Thermal Resistance(between Junction and Case)	R <sub>θ(J-C)</sub>	1.09 (Typ.)	°C/W
Junction and Storage Temperature	T <sub>J</sub> T <sub>STG</sub>	-55 ~ +175	°C

### Electronics Characteristics (T<sub>c</sub>=25°C Unless otherwise specified)

Parameter	Symbol	Typ.	Max.	Unit
Maximum Instantaneous Forward Voltage @I <sub>F</sub> =10A T <sub>J</sub> =25°C	V <sub>F</sub>	1.38	1.75	V
Maximum Instantaneous Forward Voltage @I <sub>F</sub> =10A T <sub>J</sub> =175°C		1.89	/	

Total Capacitance @ f=1MHZ T <sub>J</sub> =25°C V <sub>R</sub> =0V		550		
Total Capacitance @ f=1MHZ T <sub>J</sub> =25°C V <sub>R</sub> =200V	C	53	/	pF
Total Capacitance @ f=1MHZ T <sub>J</sub> =25°C V <sub>R</sub> =400V		48		
Total Capacitive Charge @ V <sub>R</sub> =400V	Q <sub>C</sub>	28	/	nC
Reverse leakage current @ V <sub>R</sub> =650V T <sub>J</sub> =25°C	I <sub>R</sub>	1.5	40	μA
Reverse leakage current @ V <sub>R</sub> =650V T <sub>J</sub> =175°C		12	/	

**Typical Characteristics**

Fig.1-Forward Characteristics

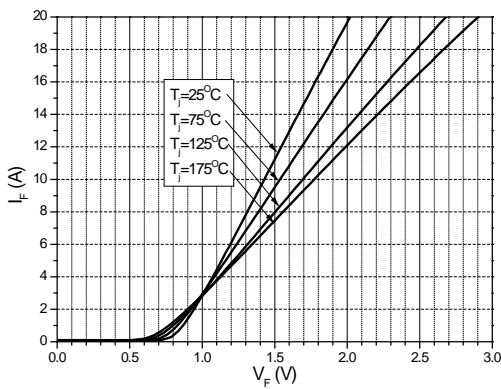

Fig.2-Reverse Characteristics

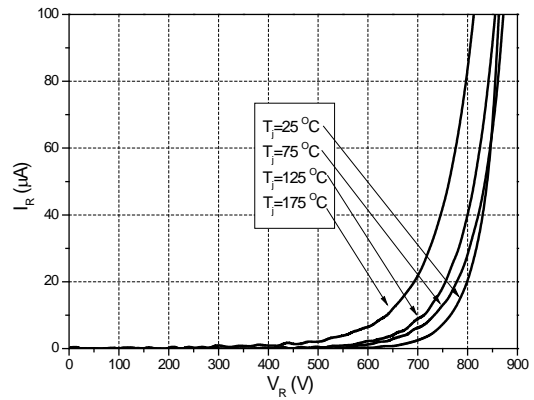

Fig.3-Total Capacitance Charge VS Reverse Voltage

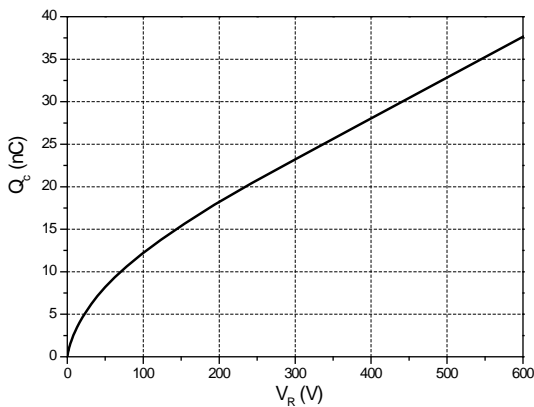
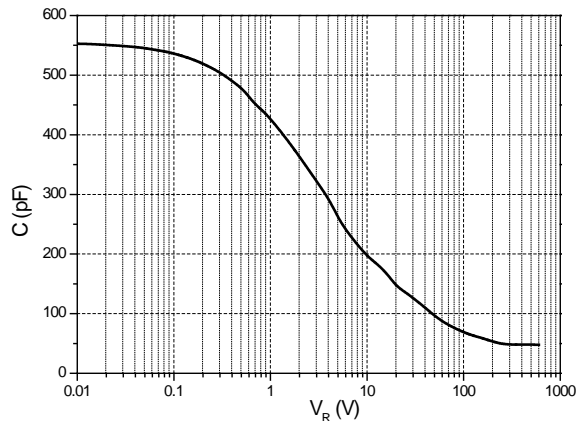
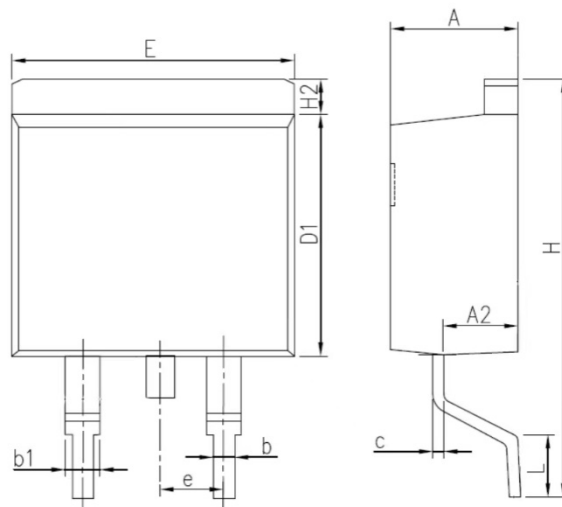

Fig.4-Capacitance VS Reverse Voltage



Outline Drawing

SYMBOL	MM	
	MIN	MAX
A	4.24	4.77
A2	2.30	2.89
b	0.70	0.96
b1	1.17	1.75
c	0.30	0.53
D1	8.50	9.6
E	9.86	10.36
e	2.54BSC	
L	1.78	2.79
H	14.61	15.88
H2	1.07	1.47



## Marking Code

Part Number	WSRSIC010065NPM
Marking Code	W010065NPM

## Part Number System

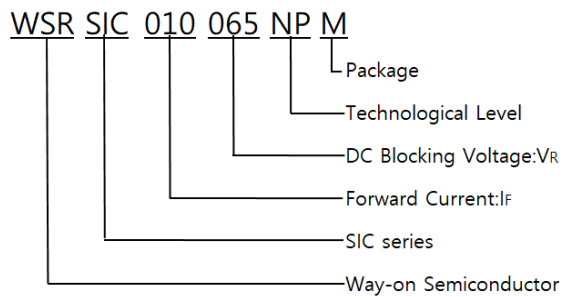

## Package Information

800pcs/Reel

## Contact Information

No.1001, Shiwan(7) Road, Pudong District, Shanghai, P.R.China.201207

Tel: 021-68969993 Fax: 86-21-50757680 Email: market@way-on.com

WAYON website: <http://www.way-on.com>

For additional information, please contact your local Sales Representative.

**WAYON**® is registered trademarks of Wayon Corporation.

*Specifications are subject to change without notice.  
The device characteristics and parameters in this data sheet can and do vary in different applications and actual device performance may vary over time.  
Users should verify actual device performance in their specific applications.*