



WSRSIC008065NPF

SILICON CARBIDE SCHOTTKY DIODE

Features

- 8A Silicon Carbide Schottky Diode
- Excellent high temperature stability
- Low forward voltage
- High forward surge capability
- 175°C Operating Junction Temperature
- Reduced temperature dependence

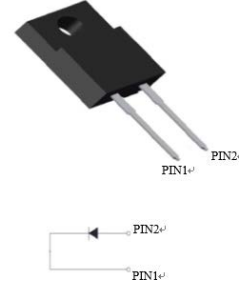

Mechanical Data

- Case: TO-220F-2L

Absolute Maximum Ratings (T_c=25°C Unless otherwise specified)

Parameter	Symbol	Value	Unit
Repetitive Peak Reverse Voltage	V _{RRM}	650	V
Surge Peak Reverse Voltage	V _{RSM}	650	V
DC Blocking Voltage	V _R	650	V
Maximum Average Forward Rectified Current at T _C =141°C	I _F	8	A
Surge(Non-Repetitive)Forward Current @ T _p =10ms Half Sine Wave T _c =25°C	I _{FSM}	50	A
Power Dissipation T _c =25°C	P _{tot}	58.6	W
Thermal Resistance(between Junction and Case)	R _{θ(J-C)}	2.559 (Typ.)	°C/W
Junction and Storage Temperature	T _J T _{STG}	-40 ~ +175	°C

Electronics Characteristics (T_c=25°C Unless otherwise specified)

Parameter	Symbol	Typ.	Max.	Unit
Maximum Instantaneous Forward Voltage @ I _F =8A T _J =25°C	V _F	1.38	1.75	V
Maximum Instantaneous Forward Voltage @ I _F =8A T _J =175°C		1.89	/	

Total Capacitance @ f=1MHZ T _J =25°C V _R =0V		440		
Total Capacitance @ f=1MHZ T _J =25°C V _R =200V	C	44	/	pF
Total Capacitance @ f=1MHZ T _J =25°C V _R =400V		38		
Total Capacitive Charge @ V _R =400V	Q _C	22	/	nC
Reverse leakage current @ V _R =V _{RWM} T _J =25°C		1.2	40	μA
Reverse leakage current @ V _R =V _{RWM} T _J =175°C	I _R	10	/	

Typical Characteristics

Fig.1-Forward Characteristics

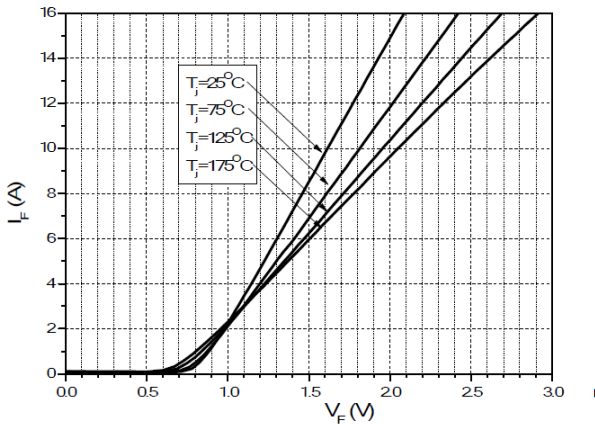

Fig.2-Reverse Characteristics

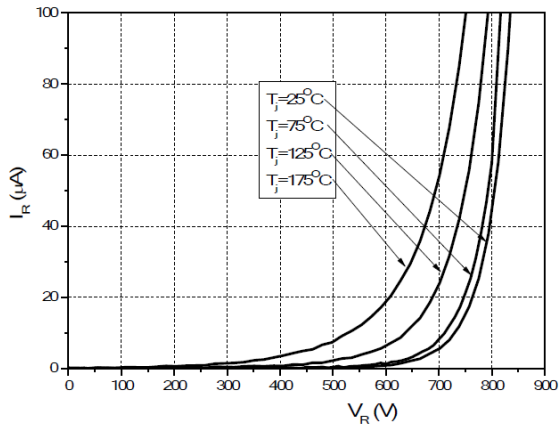

Fig.3-Total Capacitance Charge VS Reverse Voltage

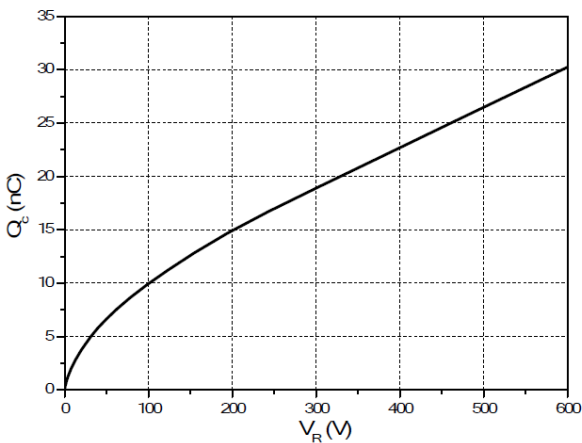
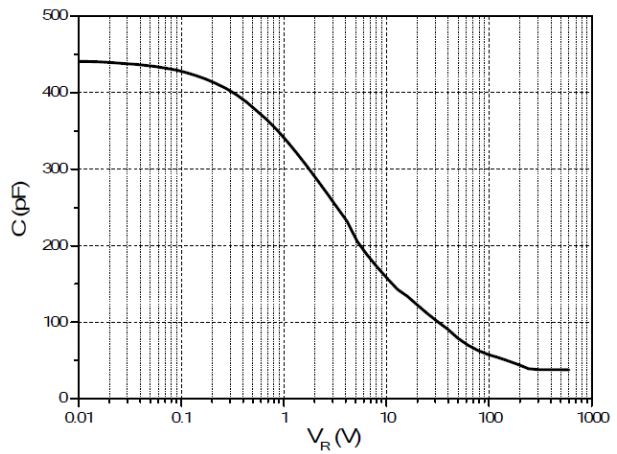
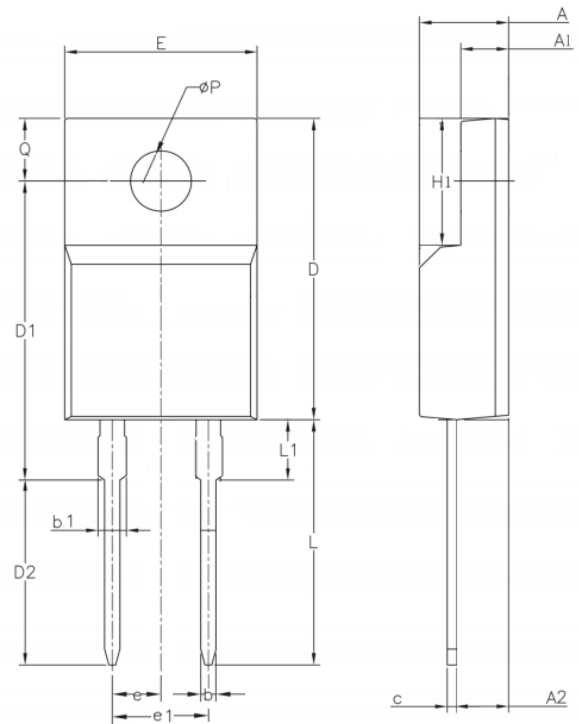

Fig.4-Capacitance VS Reverse Voltage



Outline Drawing

SYMBOL	MM	
	MIN	MAX
A	3.90	5.10
A1	2.10	3.56
A2	2.10	3.20
b	0.60	0.99
b1	1.20	1.60
c	0.40	0.80
D	14.40	16.30
D1	15.05	16.60
D2	9.10	10.50
E	8.70	10.70
e	2.54BSC	
e1	5.08BSC	
H1	6.48	6.90
L	12.60	14.20
L1	3.00	4.50
ΦP	2.60	3.80
Q	2.15	3.55



Marking Code

Part Number	WSRSIC008065NPF
Marking Code	W008065NPF

Part Number System

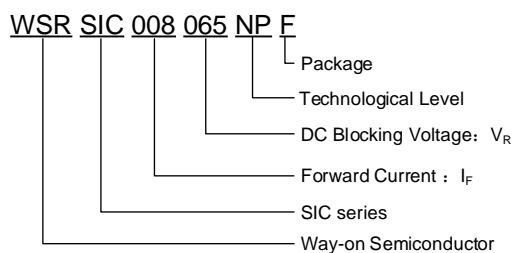

Package Information

Quantity per tube: 50pcs

Contact Information

No.1001, Shiwan(7) Road, Pudong District, Shanghai, P.R.China.201207

Tel: 021-68969993 Fax: 86-21-50757680 Email: market@way-on.com

WAYON website: <http://www.way-on.com>

For additional information, please contact your local Sales Representative.

WAYON® is registered trademarks of Wayon Corporation.

*Specifications are subject to change without notice.
The device characteristics and parameters in this data sheet can and do vary in different applications and actual device performance may vary over time.
Users should verify actual device performance in their specific applications.*