

Natural[®]

AC FAN

80mm~280mm



CE RoHS ISO9001

NA9225



General Specification

Size: 92×92×25mm
 Airflow: 37~58m³/hr 22-34CFM
 Weight: 268g
 Noise: 28~40dBA
 Impeller: PBT Black
 Frame: Aluminum Alloy
 Terminals: 0.5mm
 Lead Wire: AWG#22
 Motor: Shaded Pole Induction Motor
 Operation Temperature: -10°C~+65°C

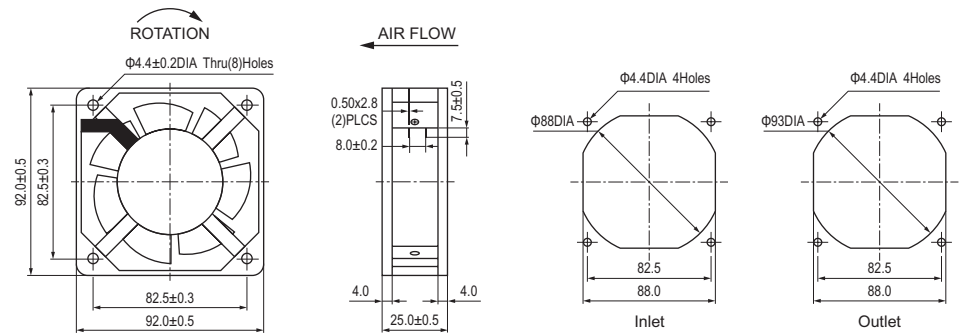

Specific Parameters

Model Number	Bearing Type	Voltage (V)	Freq. (Hz)	Current (A)	Power (W)	Speed (RPM)	Noise (dBA)	Air Flow		Phase	Capacitor
								M ³ /hr	CFM		
9225-110BH	Ball	100~125	50/60	0.14	13	2300/2800	34/40	47/58	28/34	1	/
9225-230BH	Ball	200~240	50/60	0.07	13	2300/2800	34/40	47/58	28/34	1	/
9225-110BM	Ball	100~125	50/60	0.14	13	1800/2300	28/35	37/45	22/26	1	/
9225-230BM	Ball	200~240	50/60	0.07	13	1800/2300	28/35	37/45	22/26	1	/
9225-110SH	Sleeve	100~125	50/60	0.14	13	2300/2800	34/40	47/58	28/34	1	/
9225-230SH	Sleeve	200~240	50/60	0.07	13	2300/2800	34/40	47/58	28/34	1	/
9225-110SM	Sleeve	100~125	50/60	0.14	13	1800/2300	28/35	37/45	22/26	1	/
9225-230SM	Sleeve	200~240	50/60	0.07	13	1800/2300	28/35	37/45	22/26	1	/

"B" means Ball, "S" means Sleeve, "H" means High Speed, "M" means Middle Speed, Current, Speed can be customer made

