

SMF5.0A/CA thru SMF170A/CA Series Surface Mount - 200W Transient Voltage Suppressor

Description

SMFxxxXX Series transient voltage suppressors are excellent overvoltage protective devices.

The Series is designed specifically to protect sensitive electronic equipment from voltage transients induced by lightning and other transient voltage events.

Features

- Excellent clamping capability
- Low leakage current
- Low capacitance
- High surge capability
- Glass passivated chip
- Epoxy resin package
- Built-in strain relief
- Will not fatigue
- RoHS Compliant
- Fast response time:
typically less than 1.0ps from 0 Volts to V_{BR} min

Applications

- Cellular phones
- Portable devices
- Business machines
- Power supplies
- Consumer applications

Electrical Parameters

Parameter	Definition
C_J	Junction Capacitance - typical capacitance measured with 0V or V_R bias
I_{PP}	Peak Pulse Current - maximum rated peak impulse current
V_C	Clamping Voltage - Peak voltage measured across the suppressor at a specified I_{ppm} (peak impulse current)
V_{BR}	Breakdown Voltage - Maximum voltage that flows through the TVS at a specified test current (I_T)
I_R	Leakage Current - maximum peak off-state current measured at V_R
V_R	Peak Off-state Voltage - maximum voltage that can be applied while maintaining off state

Mechanical Characteristics

- Package: SOD-123F plastic package.
- Lead Finish: Matte Tin
- Case Material: Epoxy Molding Compound.
- UL Flammability Classification Rating 94V-0
- Moisture Sensitivity: Level 1 per J-STD-020

LF RoHS



SOD-123F

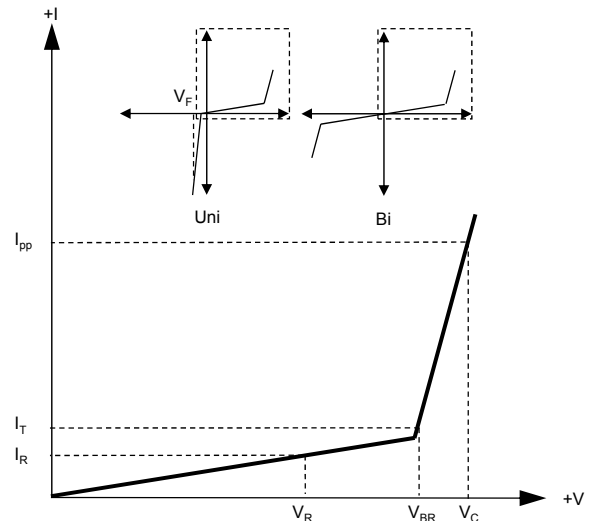

Summary of Packing Options

Package	Packing Description	Packing Quantity	Industry Standard
SOD-123F	Tape/Reel, 7" reel	3000	EIA-481-1
	Tape/Reel, 13" reel	10000	EIA-481-1

SMF5.0A/CA thru SMF170A/CA Series

 Absolute Maximum Ratings ($T_A=25^{\circ}\text{C}$ unless otherwise noted)

Parameter	Symbol	Value	Units	Remarks
Peak Pulse Power Dissipation	P_{PPM}	200	W	(Note1)(Note2)
Steady State Power Dissipation	P_D	1	W	(Note3)
Peak Forward Surge Current	I_{FSM}	20	A	(Note4)
Maximum Instantaneous Forward Voltage at 10A	V_{FM}	3.5	V	(Note5)
Typical Thermal Resistance Junction to Lead	$R_{\theta JL}$	100	$^{\circ}\text{C}/\text{W}$	
Typical Thermal Resistance Junction to Ambient	$R_{\theta JA}$	220	$^{\circ}\text{C}/\text{W}$	
Operating Temperature Range	T_J	-55 to 150	$^{\circ}\text{C}$	
Storage Temperature Range	T_{STG}	-55 to 150	$^{\circ}\text{C}$	

Notes1: Non-repetitive current pulse , 10/1000us Waveform.

Notes2: Mounted on copper pad area of 3×3mm to each terminal.

 Notes3: Infinite HeatSink at $T_A=50^{\circ}\text{C}$

Notes4: Measured on 8.3ms single half sine wave or equivalent square wave, duty cycle=4 perminute maximum.

Notes5: For UnidirectionalOnly.

SMF5.0A/CA SMF170A/CA Electrical Characteristics

Part Number		Marking Code		Reverse Stand off Voltage VR (V)	Breakdown Voltage VBR @ IT (V)		Test Current IT (mA)	Maximum Clamping Voltage VC@ IPP (V)	Maximum Peak Pulse Current IPP (A)	Maximum Reverse Leakage IR @ VR (μA)
Uni	Bi	Uni	Bi		Min	Max				
SMF5.0A	SMF5.0CA	AE	FE	5	6.4	7	10	9.2	21.7	400
SMF6.0A	SMF6.0CA	AG	FG	6	6.67	7.37	10	10.3	19.4	400
SMF6.5A	SMF6.5CA	AK	FK	6.5	7.22	7.98	10	11.2	17.9	250
SMF7.0A	SMF7.0CA	AM	FM	7	7.78	8.6	10	12	16.7	100
SMF7.5A	SMF7.5CA	AP	FP	7.5	8.33	9.21	1	12.9	15.5	50
SMF8.0A	SMF8.0CA	AR	FR	8	8.89	9.83	1	13.6	14.7	25
SMF8.5A	SMF8.5CA	AT	FT	8.5	9.44	10.4	1	14.4	13.9	10
SMF9.0A	SMF9.0CA	AV	FV	9	10	11.1	1	15.4	13	5
SMF10A	SMF10CA	AX	FX	10	11.1	12.3	1	17	11.8	2.5
SMF11A	SMF11CA	AZ	FZ	11	12.2	13.5	1	18.2	11	2.5
SMF12A	SMF12CA	BE	GE	12	13.3	14.7	1	19.9	10.1	2.5
SMF13A	SMF13CA	BG	GG	13	14.4	15.9	1	21.5	9.3	1
SMF14A	SMF14CA	BK	GK	14	15.6	17.2	1	23.2	8.6	1
SMF15A	SMF15CA	BM	GM	15	16.7	18.5	1	24.4	8.2	1
SMF16A	SMF16CA	BP	GP	16	17.8	19.7	1	26	7.7	1
SMF17A	SMF17CA	BR	GR	17	18.9	20.9	1	27.6	7.2	1
SMF18A	SMF18CA	BT	GT	18	20	22.1	1	29.2	6.8	1
SMF20A	SMF20CA	BV	GV	20	22.2	24.5	1	32.4	6.2	1

SMF5.0A/CA SMF170A/CA Electrical Characteristics

Part Number		Marking Code		Reverse Stand off Voltage VR (V)	Breakdown Voltage VBR @ IT (V)		Test Current IT (mA)	Maximum Clamping Voltage VC@ IPP (V)	Maximum Peak Pulse Current IPP (A)	Maximun Reverse Leakage IR @ VR (μA)
Uni	Bi	Uni	Bi		Min	Max				
SMF22A	SMF22CA	BX	GX	22	24.4	26.9	1	35.5	5.6	1
SMF24A	SMF24CA	BZ	GZ	24	26.7	29.5	1	38.9	5.1	1
SMF26A	SMF26CA	CE	HE	26	28.9	31.9	1	42.1	4.8	1
SMF28A	SMF28CA	CG	HG	28	31.1	34.4	1	45.4	4.4	1
SMF30A	SMF30CA	CK	HK	30	33.3	36.8	1	48.4	4.1	1
SMF33A	SMF33CA	CM	HM	33	36.7	40.6	1	53.3	3.8	1
SMF36A	SMF36CA	CP	HP	36	40	44.2	1	58.1	3.4	1
SMF40A	SMF40CA	CR	HR	40	44.4	49.1	1	64.5	3.1	1
SMF43A	SMF43CA	CT	HT	43	47.8	52.8	1	69.4	2.9	1
SMF45A	SMF45CA	CV	HV	45	50	55.3	1	72.7	2.8	1
SMF48A	SMF48CA	CX	HX	48	53.3	58.9	1	77.4	2.6	1
SMF51A	SMF51CA	CZ	HZ	51	56.7	62.7	1	82.4	2.4	1
SMF54A	SMF54CA	DE	IE	54	60	66.3	1	87.1	2.3	1
SMF58A	SMF58CA	DG	IG	58	64.4	71.2	1	93.6	2.1	1
SMF60A	SMF60CA	DK	IK	60	66.7	73.7	1	96.8	1.8	1
SMF64A	SMF64CA	DM	IM	64	71.1	78.6	1	103	1.7	1
SMF70A	SMF70CA	DP	IP	70	77.8	86	1	113	1.5	1
SMF75A	SMF75CA	DR	IR	75	83.3	92.1	1	121	1.4	1
SMF78A	SMF78CA	DT	IT	78	86.7	95.8	1	126	1.4	1
SMF85A	SMF85CA	DV	IV	85	94.4	104	1	137	1.3	1
SMF90A	SMF90CA	DX	IX	90	100	111	1	146	1.2	1
SMF100A	SMF100CA	EZ	JZ	100	111	123	1	162	1.1	1
SMF110A	SMF110CA	EE	JE	110	122	135	1	177	1	1
SMF120A	SMF120CA	EG	JG	120	133	147	1	193	0.9	1
SMF130A	SMF130CA	EK	JK	130	144	159	1	209	0.8	1
SMF150A	SMF150CA	EM	JM	150	167	185	1	243	0.7	1
SMF160A	SMF160CA	EP	JP	160	178	197	1	259	0.7	1
SMF170A	SMF170CA	ER	JR	170	189	209	1	275	0.6	1

SMF5.0A/CA thru SMF170A/CA Series

Rating And Characteristic Curves ($T_A=25^\circ\text{C}$ unless otherwise noted)

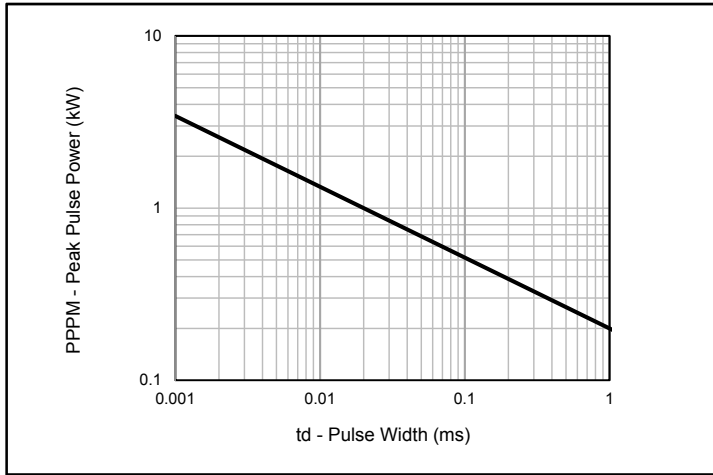

Fig.1 - Peak Pulse Power Rating

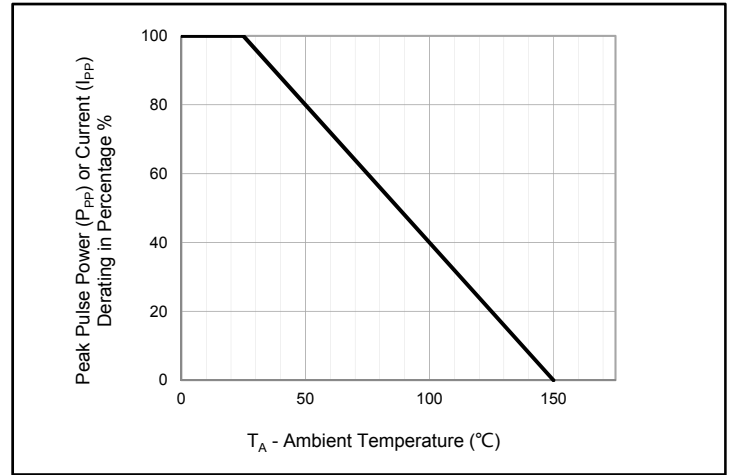

Fig.2 - Pulse Derating Curve

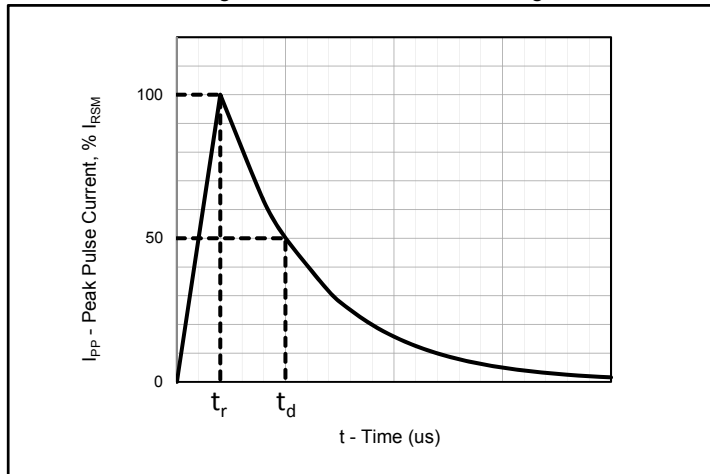

Fig.3 - Pulse Waveform

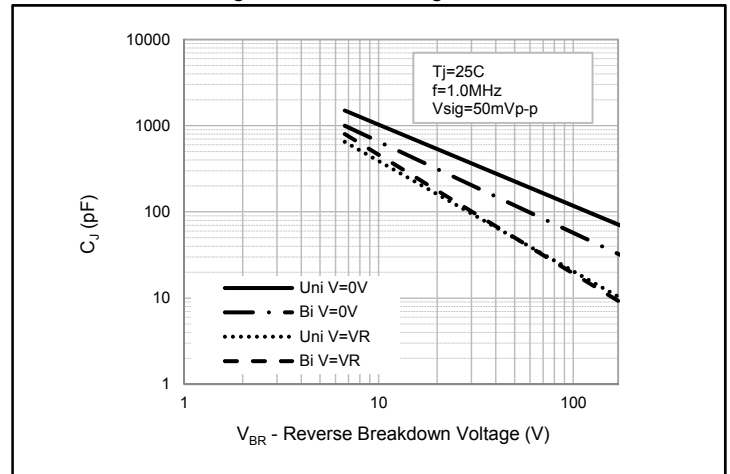

Fig.4 - Typical Junction Capacitance

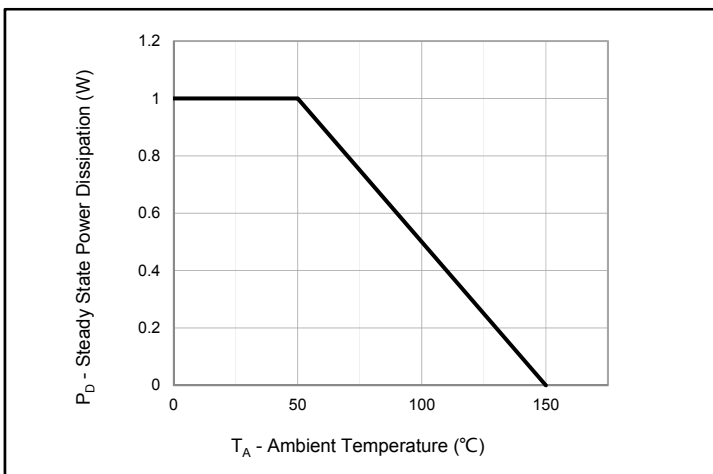

Fig.5 - Steady State Power Dissipation Derating Curve

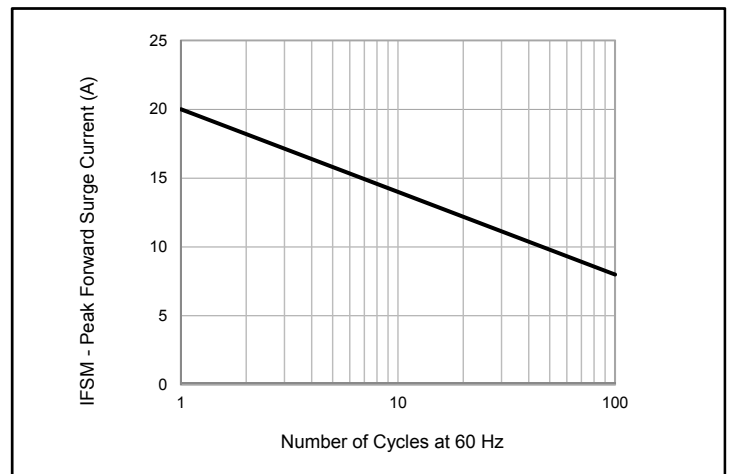
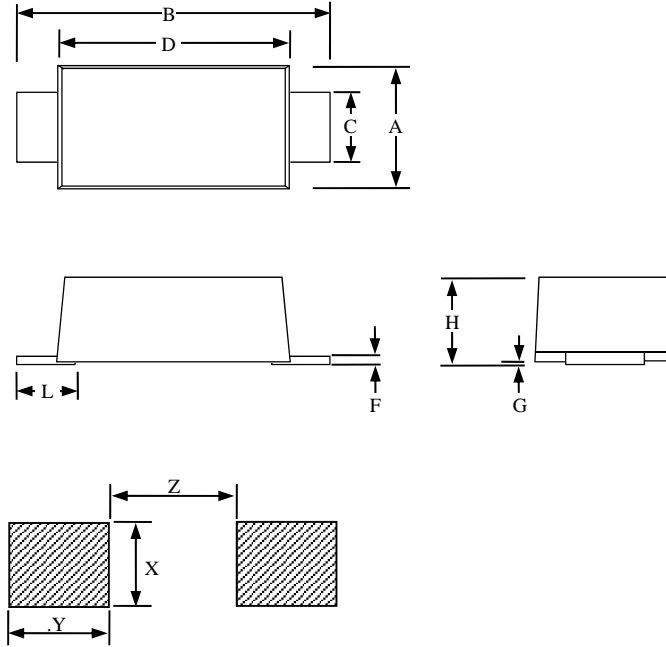

Fig.6 - Maximum Non-Repetitive Peak Forward Surge Current
Uni-Directional Only

SMF5.0A/CA thru SMF170A/CA Series

Package Dimensions



SOD-123F						
Dimension	Inches			Millimeters		
	MIN	NOM	MAX	MIN	NOM	MAX
A	0.059		0.079	1.5		2
B	0.134		0.154	3.4		3.9
C	0.028		0.047	0.7		1.2
D	0.098		0.114	2.5		2.9
F	0.002		0.01	0.05		0.26
G	-		0.004	-		0.1
H	0.037		0.053	0.95		1.2
L	0.014		0.035	0.35		0.9
X		0.055			1.4	
Y		0.051			1.3	
Z		0.063			1.6	

SMF5.0A/CA thru SMF170A/CA Series

Soldering Parameters

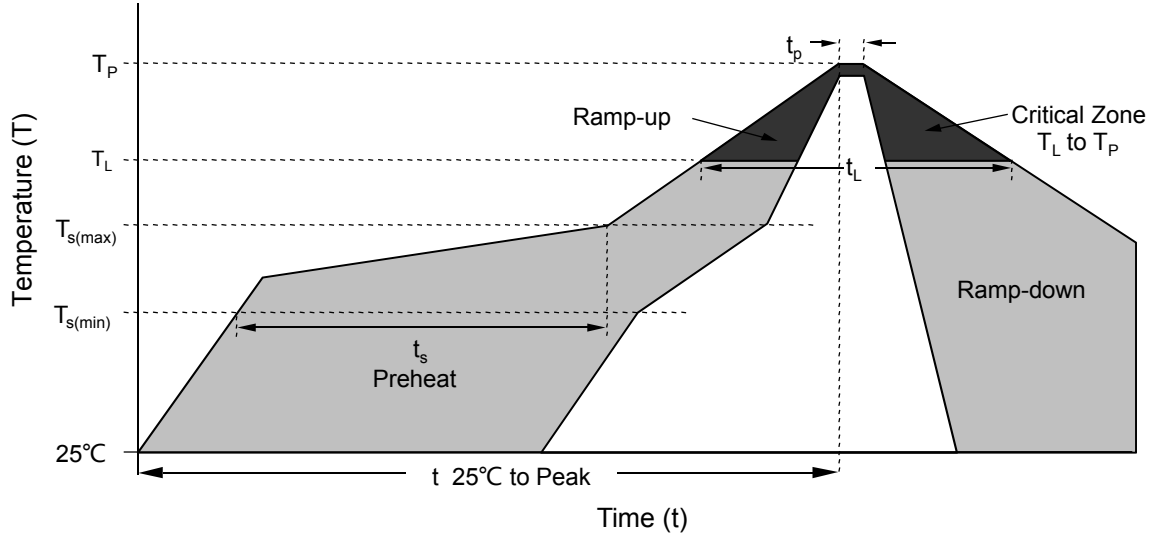

Reflow Condition		Lead-free assembly
Pre Heat	- Temperature Min ($T_{s(min)}$)	150°C
	- Temperature Max ($T_{s(max)}$)	200°C
	- Time (min to max) (t_s)	60 – 180 secs
Average ramp up rate (Liquidus Temp (T_L) to peak)		3°C/second max
$T_{s(max)}$ to T_L - Ramp-up Rate		3°C/second max
Reflow	- Temperature (T_L) (Liquidus)	217°C
	- Time (t_L)	60 – 150 secs
Peak Temperature (T_P)		260 ^{+0/-5} °C
Time within 5°C of actual peak Temperature (t_p)		20 – 40 secs
Ramp-down Rate		6°C/second max
Time 25°C to peak Temperature (t)		8 minutes Max.
Do not exceed		260°C