

12W FDS-DALI-2 Dimming power supply



■ Approve



Features

- Class II,SELV,built-in
- Input Voltage 220-240VAC
- Protections: SCP/OLP/OVP/OTP
- Power Factor: >0.95
- Efficiency: ≥82%
- Adjustable Output Current with dip-switch
- Support DALI-2
- 5 years warranty

Applications

- Track light

◆ Description

FDS-12-350 DALI-2 LD is a 12W constant current LED driver that operates from 198-264Vac input with 120 to 350mA output current and a forward voltage range from 9 to 42Vdc. The output current is adjustable by DIP Switch. With it's compact dimensions from 212 x 31 x 45 mm it is easy to integrate in track light products. To ensure trouble-free operation, protection is provided against output short circuit and over Load.

◆ Model code

FDS-12-350 DALI-2 LD

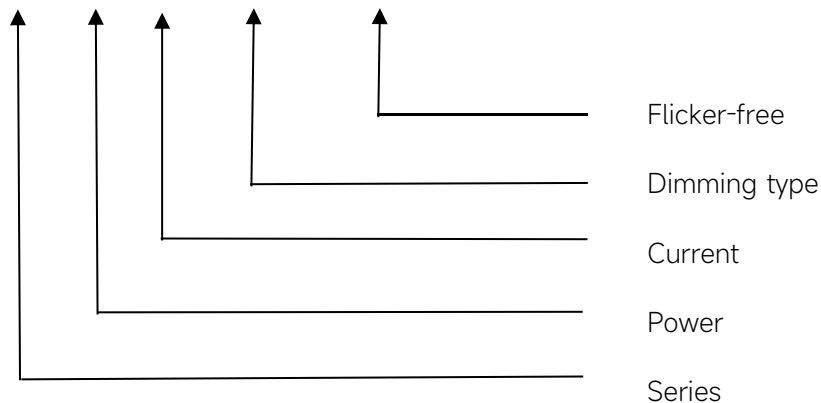

◆ Specification

	Constant Current (mA)	120	150	180	200	250	280	300	350	
Output	Voltage Range (VDC)	9-42VDC								
	Unload voltage Max.	57VDC								
	Current Accuracy	±7%					±5%			
	Output LF current ripple(≤120Hz)	±5%								
	SVM	≤0.4								
	P _{st}	≤1								
	Efficiency(Typ.)	≥82%@Full load								
	Input	Rated input voltage	220-240VAC							
Range of input voltage		198-264VAC								
Range input voltage(DC)		198-280VDC								
Frequency(Hz)		0/50/60 Hz								
Displacement factor		≥0.7								
Power Factor		>0.95@Full load								
Input Current		0.12A								
Start-up time		< 0.5S								
No Load Power		≤0.5W								
Standby Power		≤0.5W								
Network standby power		≤0.5W								
THD (Typ.)		<10%@Full load								
Dimming	Dimming	YES								
	Dimming mode	DALI-2 (IEC 62386-101,102,207)								
	Dimming depth	1%								
	Dimming current range	1 ~100%								
Protection	Over Load Protection	103-120%								
		YES/Latch off								
	Over Voltage Protection	> 57VDC								
		YES/Latch off								
Environment	Short circuit Protection	YES/Latch off								
	Over Temperature Protection	YES/Auto Resume								
	Operating Temperature	-20°C~+45°C								
	Humidity	20%-90%RH								
	T _c	70°C								
Surface	Storage Temperature	-25°C~+60°C								
	Lifetime	>60000h,@T _c =50°C								
Surface	Dimension	212X31X45(LXWXH)mm								

standards	EN 61347-1,EN 61347-2-13(CE-LVD,ENEC) IEC 61347-1,IEC 61347-2-13(CB) EN 62384(ENEC) EN IEC 55015,EN IEC 61000-3-2,EN 61000-3-3(CE-EMC,RCM) EN 61547(CE-EMC,RCM)	
Others	ErP	EU 2019/2020
	RoHS	RoHS (2011/65/EU) (EU)2015/863
Note	1.All parameters NOT specially mentioned are measured at 230VAC input , full load and 25°C of ambient temperature. 2.Ripple & Noise are measured at 20MHz of bandwidth by using a 300mm twisted pair-wire terminated with a 0.1uF & 47 uF parallel capacitor.	

◆ Parameter

Number	Output	Switch position		
	Current(mA)	1	2	3
1	120	--	--	--
2	150	ON	--	--
3	180	--	ON	--
4	200	ON	ON	--
5	250	--	--	ON
6	280	ON	--	ON
7	300	--	ON	ON
*8	350	ON	ON	ON

* Factory default

◆ Circuit Breaker

I ^{peak}	T ^{width}	B10	B16	B20	C10	C16	C20
7.96A	116μs	66pcs	106pcs	133pcs	66pcs	106pcs	133pcs

◆ **Wiring diagram**

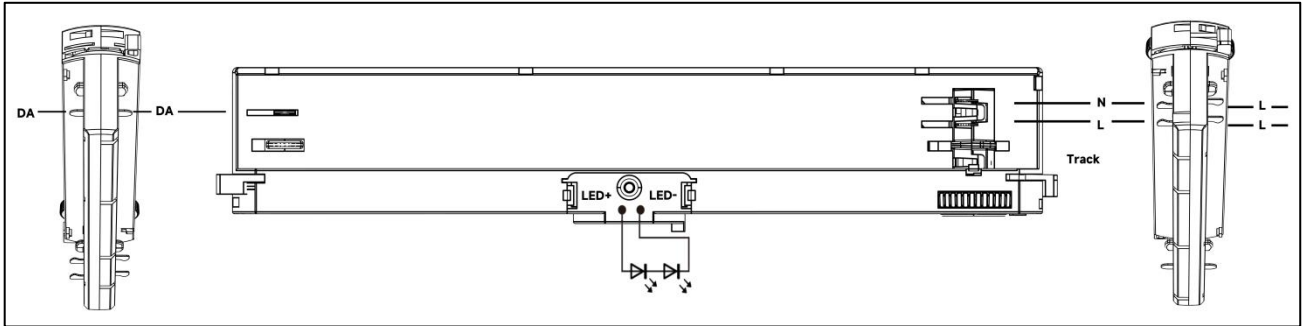

◆ **2D diagram**

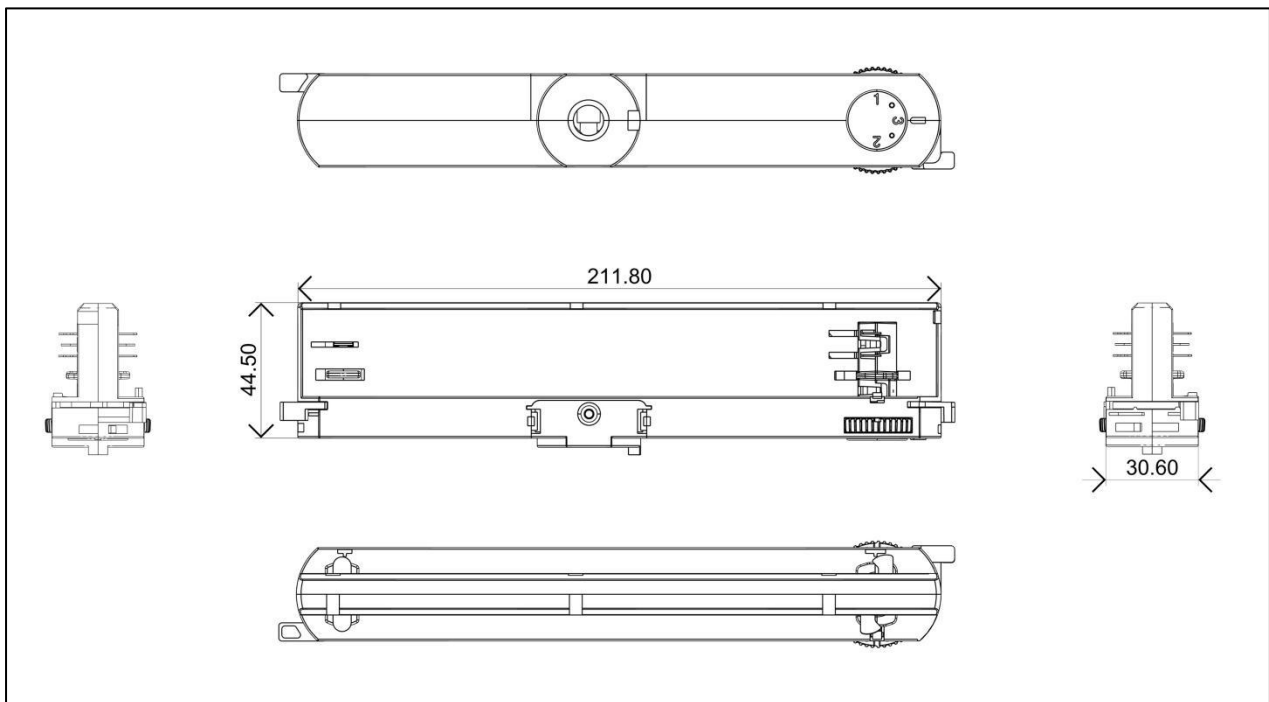

◆ **Wiring & Connections**

Specification item		Value (Unit)
Output	Output wire cross-section	0.5...1.5 mm ²
	Output wire gauge.	16...20 AWG
	Output wire strip length	8...9mm

◆ **Curve for FDS-12-350 DALI-2 LD, I_o=350mA**

Lifetime vs. Temperature Curve

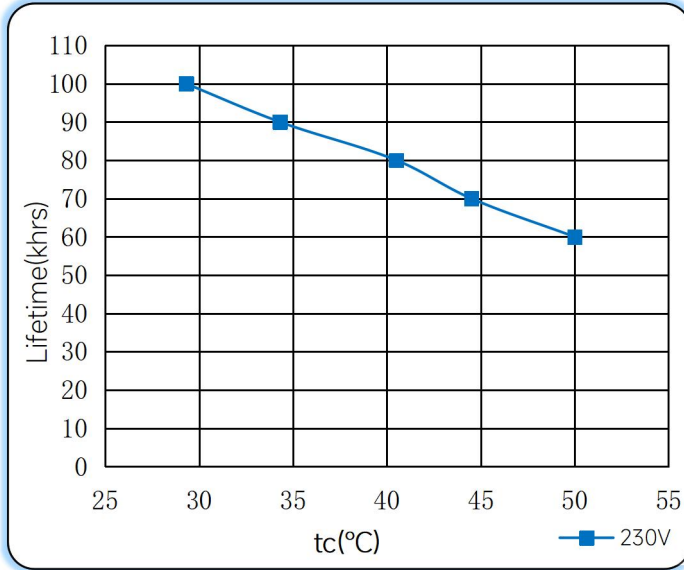

Efficiency vs. Load

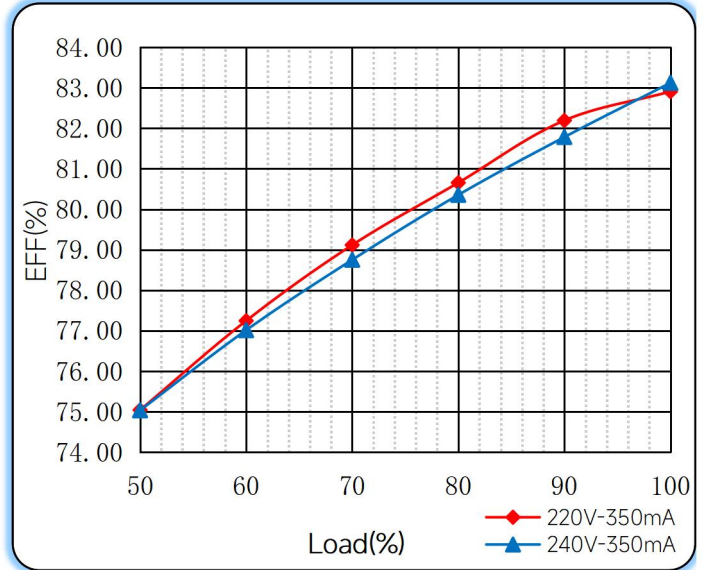

Power Factor Characteristics

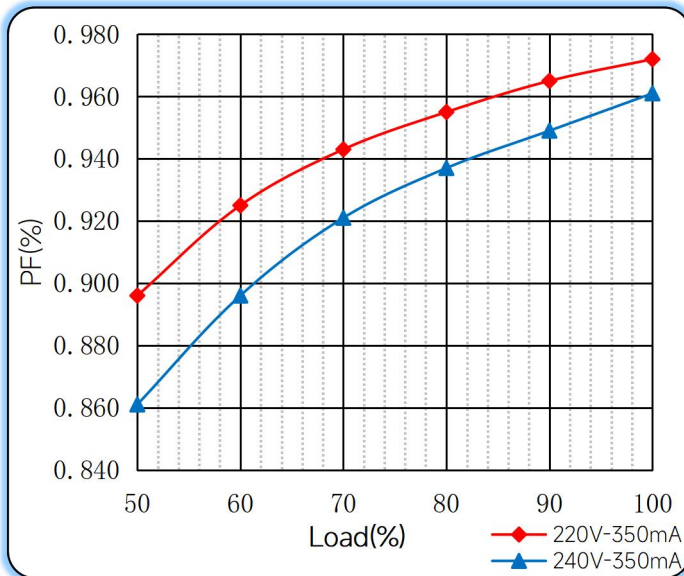

THD vs. Load

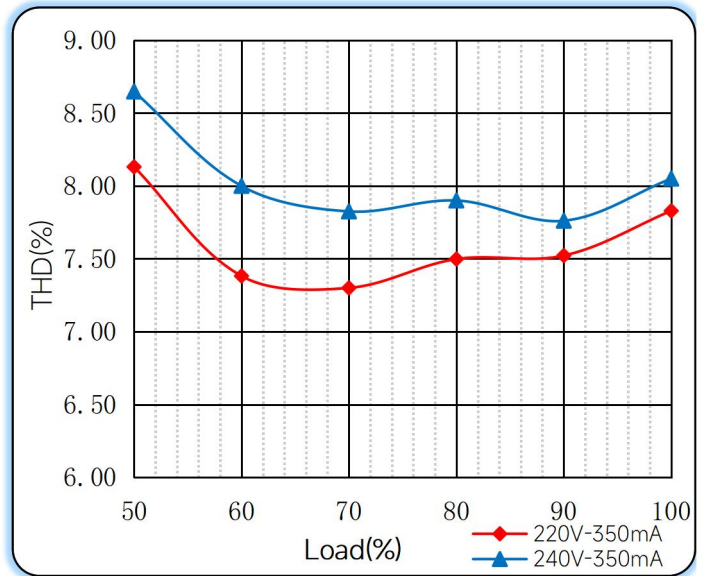

◆ Operating window

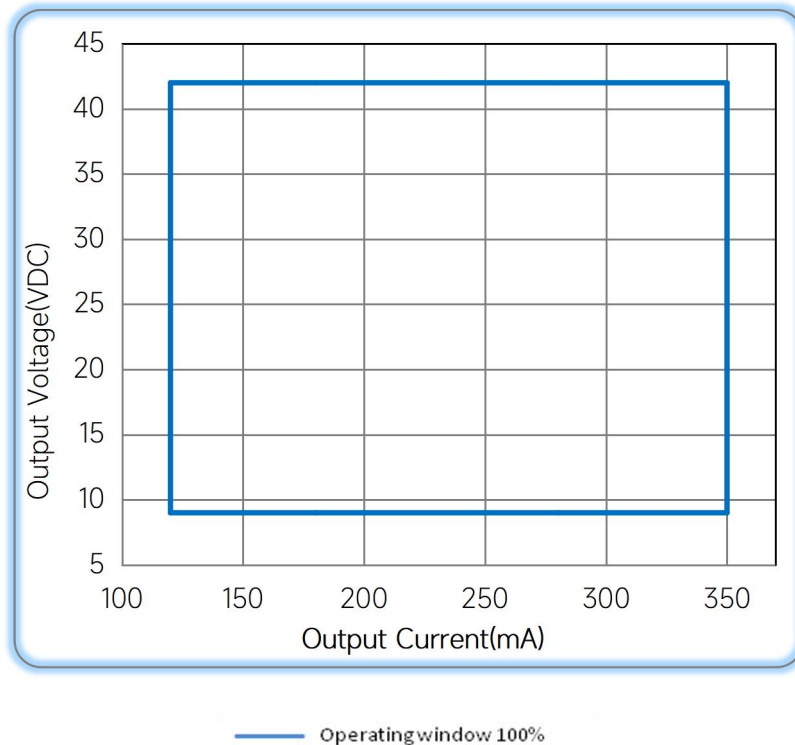

◆ Revision Updates

ITEM	BEFORE	AFTER	VERSION	DATE
Initial			A	2022/10/24

Tel: +86-0757-86256822, +86-0757-86256831

E-mail: sales@eaglerise.com

Website : <https://lighting.eaglerise.com>



EAGLERISE



Manual