

General Description

These N-Channel enhancement mode power field effect transistors are using trench DMOS technology. This advanced technology has been especially tailored to minimize on-state resistance, provide superior switching performance, and withstand high energy pulse in the avalanche and commutation mode. These devices are well suited for high efficiency fast switching applications.

BVDSS	RDSON	ID
80V	100mΩ	12A

Features

- 80V, 12A, RDS(ON)=100mΩ@VGS = 10V
- Improved dv/dt capability
- Fast switching
- 100% EAS Guaranteed
- Green Device Available

TO251 Pin Configuration

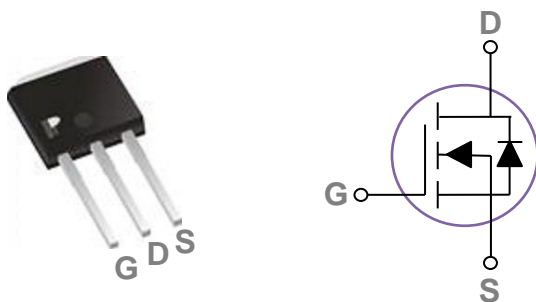

Applications

- Motor Drive
- Power Tools
- LED Lighting

Absolute Maximum Ratings $T_c=25^\circ\text{C}$ unless otherwise noted

Symbol	Parameter	Rating	Units
V_{DS}	Drain-Source Voltage	80	V
V_{GS}	Gate-Source Voltage	± 20	V
I_D	Drain Current – Continuous ($T_c=25^\circ\text{C}$)	12	A
	Drain Current – Continuous ($T_c=100^\circ\text{C}$)	7.6	A
I_{DM}	Drain Current – Pulsed ¹	48	A
P_D	Power Dissipation ($T_c=25^\circ\text{C}$)	35	W
	Power Dissipation – Derate above 25°C	0.28	W/ $^\circ\text{C}$
T_{STG}	Storage Temperature Range	-55 to 150	$^\circ\text{C}$
T_J	Operating Junction Temperature Range	-55 to 150	$^\circ\text{C}$

Thermal Characteristics

Symbol	Parameter	Typ.	Max.	Unit
$R_{\theta JA}$	Thermal Resistance Junction to ambient	---	62	$^\circ\text{C}/\text{W}$
$R_{\theta JC}$	Thermal Resistance Junction to Case	---	3.6	$^\circ\text{C}/\text{W}$

Electrical Characteristics (T_J=25 °C, unless otherwise noted)
Off Characteristics

Symbol	Parameter	Conditions	Min.	Typ.	Max.	Unit
BV _{DSS}	Drain-Source Breakdown Voltage	V _{GS} =0V, I _D =250μA	80	---	---	V
ΔBV _{DSS} /ΔT _J	BV _{DSS} Temperature Coefficient	Reference to 25°C, I _D =1mA	---	0.09	---	V/°C
I _{DSS}	Drain-Source Leakage Current	V _{DS} =80V, V _{GS} =0V, T _J =25°C	---	---	1	μA
		V _{DS} =64V, V _{GS} =0V, T _J =125°C	---	---	10	μA
I _{GSS}	Gate-Source Leakage Current	V _{GS} =±20V, V _{DS} =0V	---	---	±100	nA

On Characteristics

R _{DS(ON)}	Static Drain-Source On-Resistance	V _{GS} =10V, I _D =10A	---	77	100	mΩ
		V _{GS} =4.5V, I _D =8A	---	80	115	mΩ
V _{GS(th)}	Gate Threshold Voltage	V _{GS} =V _{DS} , I _D =250μA	1.2	1.8	2.5	V
ΔV _{GS(th)}	V _{GS(th)} Temperature Coefficient		---	-4.4	---	mV/°C
g _{fs}	Forward Transconductance	V _{DS} =10V, I _D =10A	---	7	---	S

Dynamic and switching Characteristics

Q _g	Total Gate Charge ^{2, 3}	V _{DS} =40V, V _{GS} =10V, I _D =10A	---	19.2	29	nC
Q _{gs}	Gate-Source Charge ^{2, 3}		---	3.3	6	
Q _{gd}	Gate-Drain Charge ^{2, 3}		---	3.5	7	
T _{d(on)}	Turn-On Delay Time ^{2, 3}	V _{DD} =30V, V _{GS} =10V, R _G =6Ω I _D =1A	---	5	10	ns
T _r	Rise Time ^{2, 3}		---	25	50	
T _{d(off)}	Turn-Off Delay Time ^{2, 3}		---	22	44	
T _f	Fall Time ^{2, 3}		---	8	16	
C _{iss}	Input Capacitance	V _{DS} =30V, V _{GS} =0V, F=1MHz	---	1070	1550	pF
C _{oss}	Output Capacitance		---	40	60	
C _{rss}	Reverse Transfer Capacitance		---	35	50	
R _g	Gate resistance		V _{GS} =0V, V _{DS} =0V, F=1MHz	---	1	

Drain-Source Diode Characteristics and Maximum Ratings

Symbol	Parameter	Conditions	Min.	Typ.	Max.	Unit
I _S	Continuous Source Current	V _G =V _D =0V, Force Current	---	---	12	A
I _{SM}	Pulsed Source Current		---	---	24	A
V _{SD}	Diode Forward Voltage	V _{GS} =0V, I _S =1A, T _J =25°C	---	---	1	V

Note :

1. Repetitive Rating : Pulsed width limited by maximum junction temperature.
2. The data tested by pulsed, pulse width ≤ 300μs, duty cycle ≤ 2%.
3. Essentially independent of operating temperature.

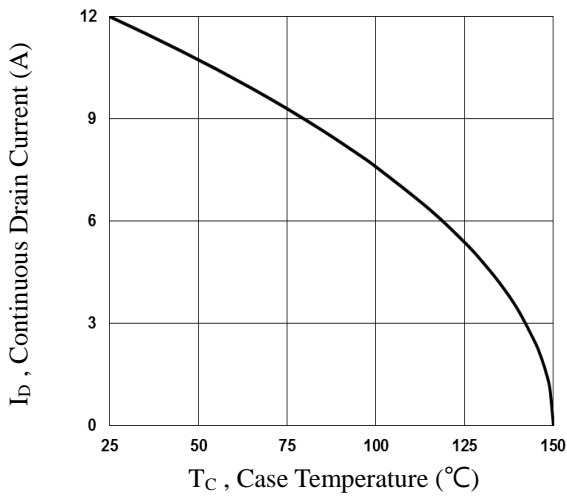

Fig.1 Continuous Drain Current vs. T_c

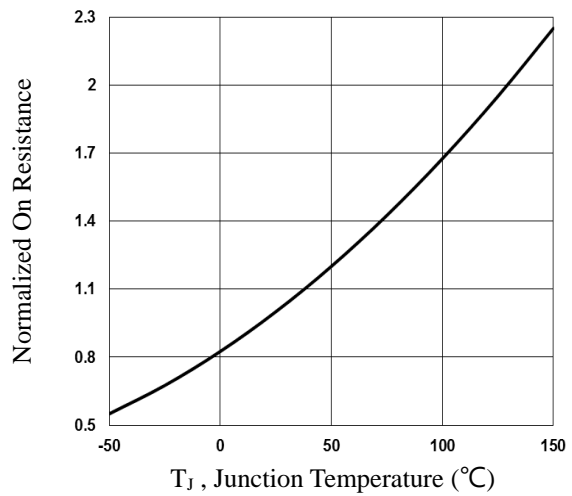

Fig.2 Normalized $R_{DS(on)}$ vs. T_j

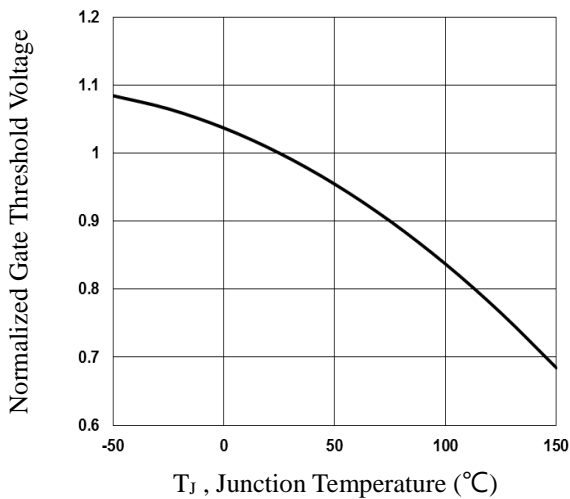

Fig.3 Normalized V_{th} vs. T_j

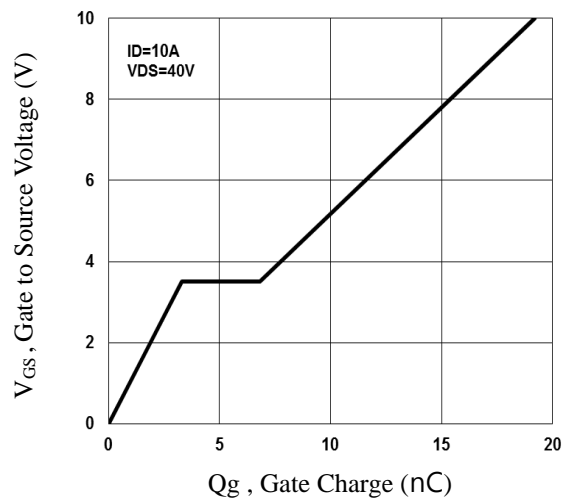

Fig.4 Gate Charge Waveform

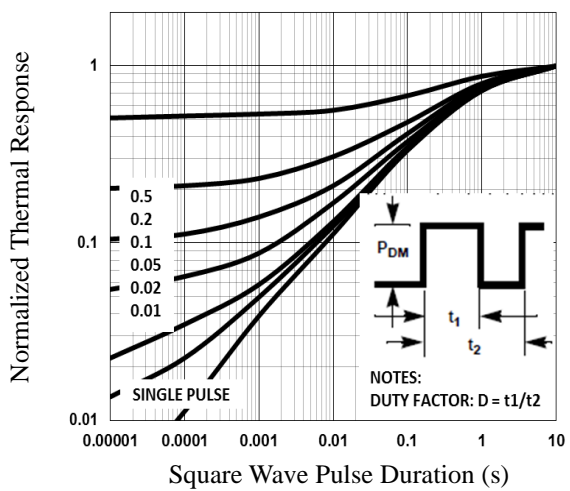

Fig.5 Normalized Transient Impedance

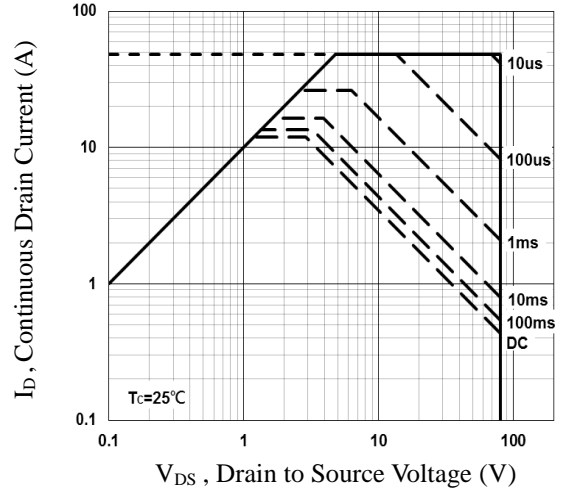

Fig.6 Maximum Safe Operation Area

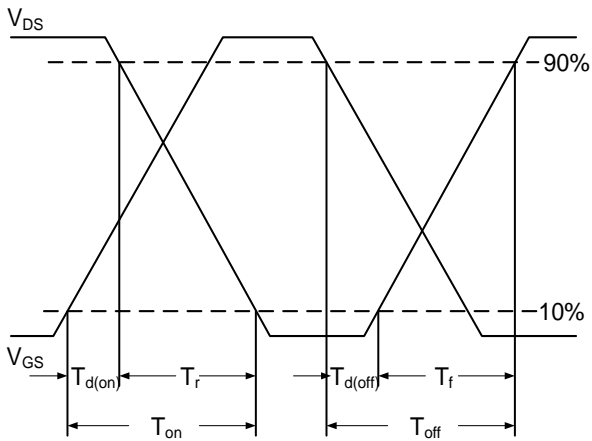

Fig.7 Switching Time Waveform

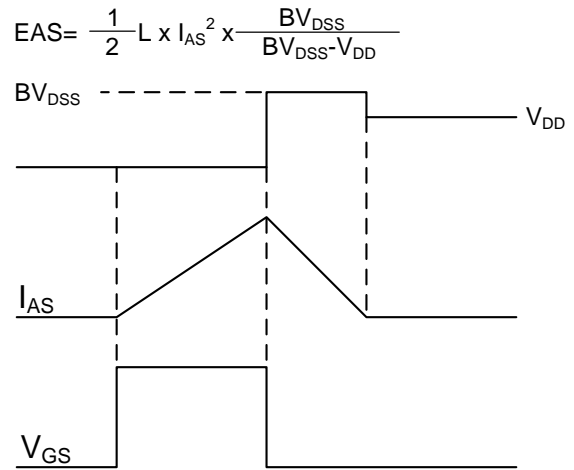
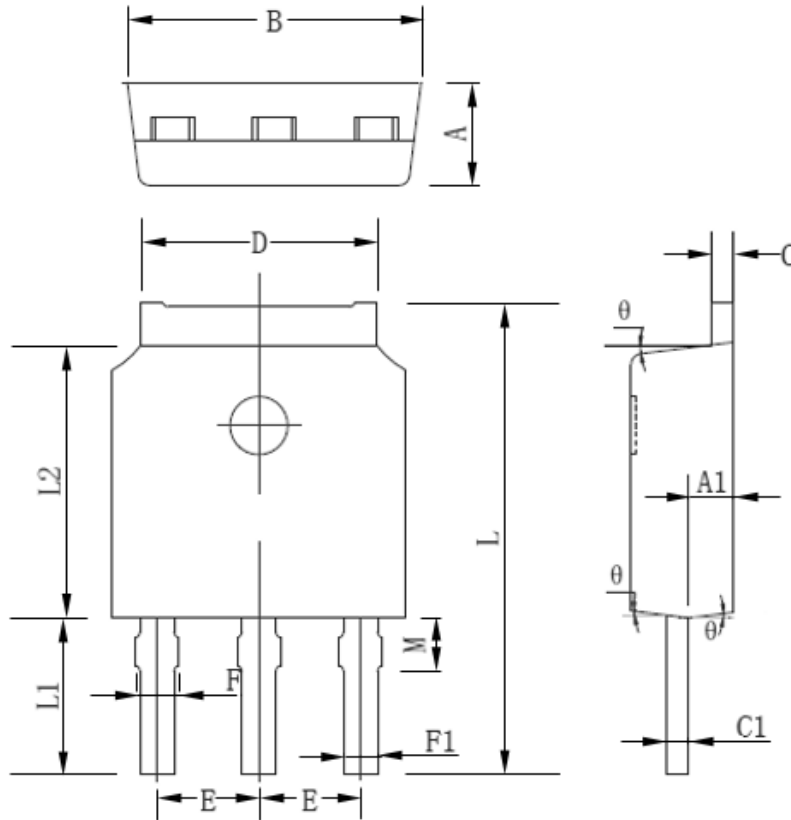

Fig.8 EAS Waveform

TO251 PACKAGE INFORMATION



Symbol	Dimensions In Millimeters		Dimensions In Inches	
	Min	Max	Min	Max
A	2.200	2.400	0.087	0.094
A1	0.910	1.110	0.036	0.044
B	6.500	6.700	0.256	0.264
C	0.460	0.580	0.018	0.023
C1	0.460	0.580	0.018	0.023
D	5.120	5.520	0.202	0.217
E	2.186	2.386	0.086	0.094
F	0.780	1.020	0.030	0.040
F1	0.660	0.860	0.026	0.034
L	10.200	10.800	0.402	0.425
L1	3.200	3.800	0.126	0.150
L2	6.000	6.200	0.236	0.244
M	1.000	1.200	0.039	0.047
θ	3°	9°	3°	9°