

**General Description**

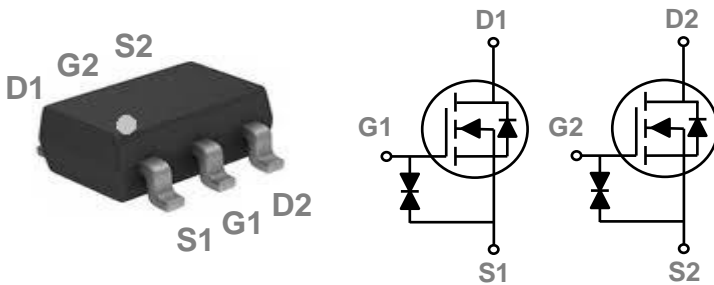
These dual N Channel enhancement mode power field effect transistors are using trench DMOS technology. This advanced technology has been especially tailored to minimize on-state resistance, provide superior switching performance, and withstand high energy pulse in the avalanche and commutation mode. These devices are well suited for high efficiency fast switching applications.

BVDSS	RDSON	ID
20V	300mΩ	800mA

**Features**

- Fast switching
- Green Device Available
- Suit for 1.5V Gate Drive Applications

**SOT363 Dual Pin Configuration**



**Applications**

- Notebook
- Load Switch
- Networking
- Hand-held Instruments

**Absolute Maximum Ratings** Tc=25°C unless otherwise noted

Symbol	Parameter	Rating	Units
V <sub>DS</sub>	Drain-Source Voltage	20	V
V <sub>GS</sub>	Gate-Source Voltage	±8	V
I <sub>D</sub>	Drain Current – Continuous (T <sub>A</sub> =25°C)	800	mA
	Drain Current – Continuous (T <sub>A</sub> =70°C)	640	mA
I <sub>DM</sub>	Drain Current – Pulsed <sup>1</sup>	3.2	A
P <sub>D</sub>	Power Dissipation (T <sub>A</sub> =25°C)	275	mW
	Power Dissipation – Derate above 25°C	2.2	mW/°C
T <sub>STG</sub>	Storage Temperature Range	-55 to 150	°C
T <sub>J</sub>	Operating Junction Temperature Range	-55 to 150	°C

**Thermal Characteristics**

Symbol	Parameter	Typ.	Max.	Unit
R <sub>θJA</sub>	Thermal Resistance Junction to ambient	---	450	°C/W

**Electrical Characteristics (T<sub>J</sub>=25 °C, unless otherwise noted)**
**Off Characteristics**

Symbol	Parameter	Conditions	Min.	Typ.	Max.	Unit
BV <sub>DSS</sub>	Drain-Source Breakdown Voltage	V <sub>GS</sub> =0V, I <sub>D</sub> =250μA	20	---	---	V
ΔBV <sub>DSS</sub> /ΔT <sub>J</sub>	BV <sub>DSS</sub> Temperature Coefficient	Reference to 25°C, I <sub>D</sub> =1mA	---	-0.01	---	V/°C
I <sub>DSS</sub>	Drain-Source Leakage Current	V <sub>DS</sub> =20V, V <sub>GS</sub> =0V, T <sub>J</sub> =25°C	---	---	1	μA
		V <sub>DS</sub> =16V, V <sub>GS</sub> =0V, T <sub>J</sub> =125°C	---	---	10	μA
I <sub>GSS</sub>	Gate-Source Leakage Current	V <sub>GS</sub> =±8V, V <sub>DS</sub> =0V	---	---	±10	μA

**On Characteristics**

R <sub>DS(ON)</sub>	Static Drain-Source On-Resistance	V <sub>GS</sub> =4.5V, I <sub>D</sub> =0.5A	---	200	300	mΩ
		V <sub>GS</sub> =2.5V, I <sub>D</sub> =0.4A	---	235	400	
		V <sub>GS</sub> =1.8V, I <sub>D</sub> =0.2A	---	295	550	
		V <sub>GS</sub> =1.5V, I <sub>D</sub> =0.1A	---	365	800	
		V <sub>GS</sub> =1.2V, I <sub>D</sub> =0.1A	---	600	1500	
V <sub>GS(th)</sub>	Gate Threshold Voltage	V <sub>GS</sub> =V <sub>DS</sub> , I <sub>D</sub> =250μA	0.3	0.6	1.0	V
ΔV <sub>GS(th)</sub>	V <sub>GS(th)</sub> Temperature Coefficient		---	-1.6	---	mV/°C

**Dynamic and switching Characteristics**

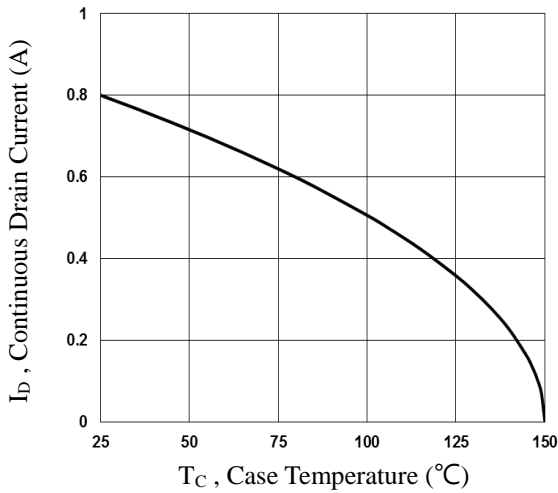
Q <sub>g</sub>	Total Gate Charge <sup>2, 3</sup>	V <sub>DS</sub> =10V, V <sub>GS</sub> =4.5V, I <sub>D</sub> =0.5A	---	1	2	nC
Q <sub>gs</sub>	Gate-Source Charge <sup>2, 3</sup>		---	0.26	0.5	
Q <sub>gd</sub>	Gate-Drain Charge <sup>2, 3</sup>		---	0.2	0.4	
T <sub>d(on)</sub>	Turn-On Delay Time <sup>2, 3</sup>	V <sub>DD</sub> =10V, V <sub>GS</sub> =4.5V, R <sub>G</sub> =10Ω I <sub>D</sub> =0.5A	---	5	10	ns
T <sub>r</sub>	Rise Time <sup>2, 3</sup>		---	3.5	7	
T <sub>d(off)</sub>	Turn-Off Delay Time <sup>2, 3</sup>		---	14	28	
T <sub>f</sub>	Fall Time <sup>2, 3</sup>		---	6	12	
C <sub>iss</sub>	Input Capacitance	V <sub>DS</sub> =10V, V <sub>GS</sub> =0V, F=1MHz	---	38.2	75	pF
C <sub>oss</sub>	Output Capacitance		---	14.4	28	
C <sub>rss</sub>	Reverse Transfer Capacitance		---	6	12	

**Drain-Source Diode Characteristics and Maximum Ratings**

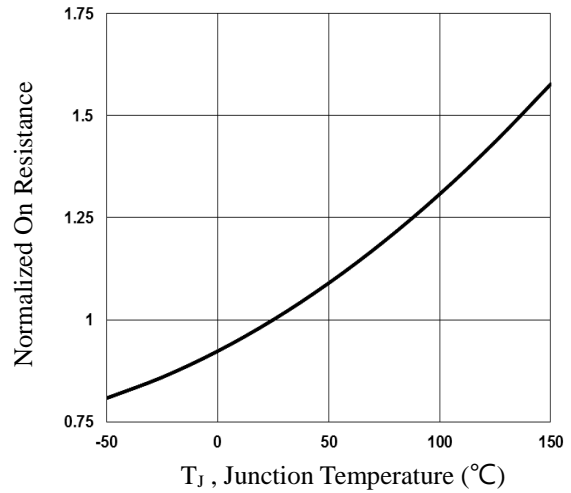
Symbol	Parameter	Conditions	Min.	Typ.	Max.	Unit
I <sub>S</sub>	Continuous Source Current	V <sub>G</sub> =V <sub>D</sub> =0V, Force Current	---	---	0.8	A
I <sub>SM</sub>	Pulsed Source Current		---	---	1.6	A
V <sub>SD</sub>	Diode Forward Voltage	V <sub>GS</sub> =0V, I <sub>S</sub> =0.3A, T <sub>J</sub> =25°C	---	---	1	V

Note :

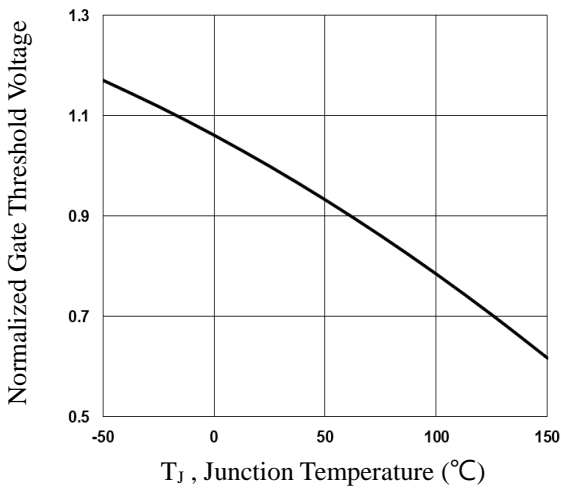
1. Repetitive Rating : Pulsed width limited by maximum junction temperature.
2. The data tested by pulsed, pulse width ≤ 300us, duty cycle ≤ 2%.
3. Essentially independent of operating temperature.



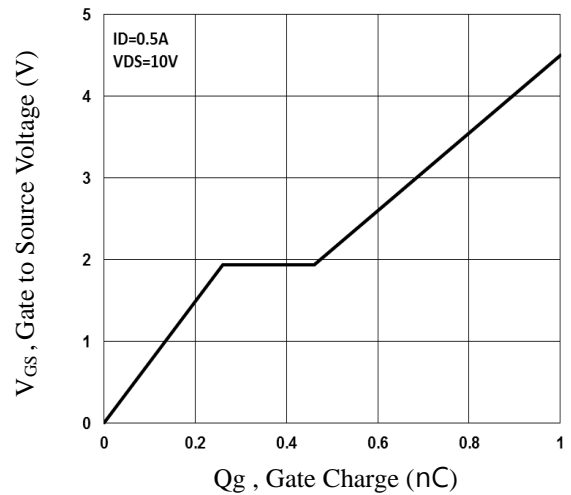
**Fig.1 Continuous Drain Current vs.  $T_c$**



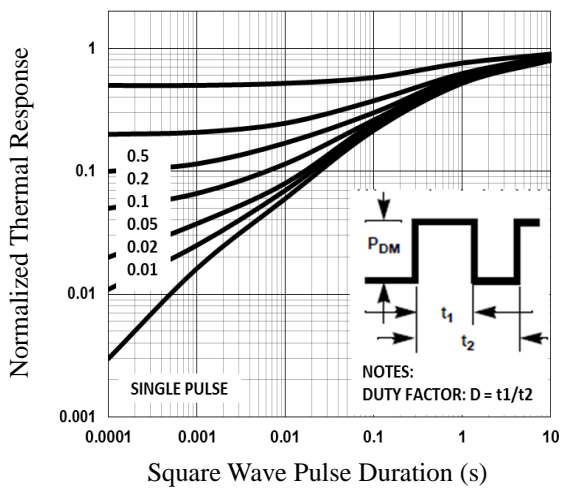
**Fig.2 Normalized  $R_{DS(on)}$  vs.  $T_j$**



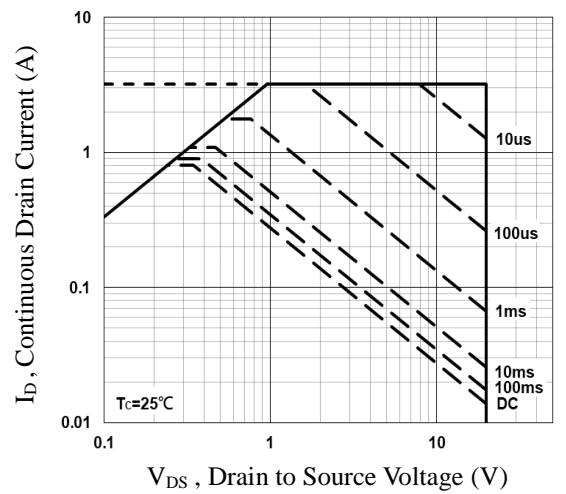
**Fig.3 Normalized  $V_{th}$  vs.  $T_j$**



**Fig.4 Gate Charge Waveform**

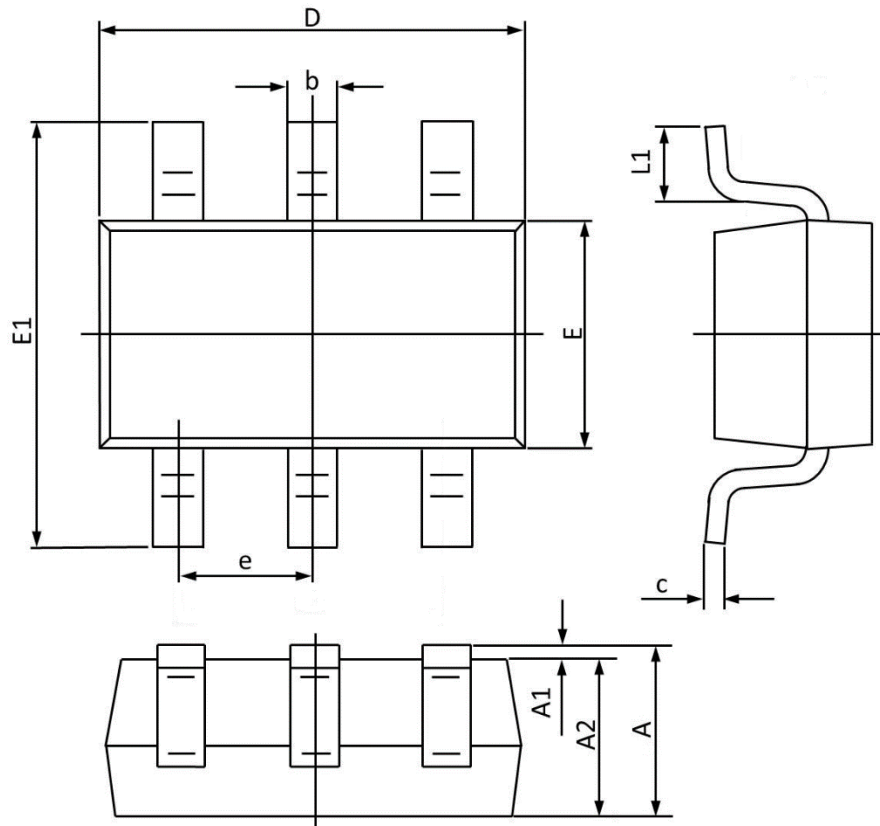


**Fig.5 Normalized Transient Impedance**



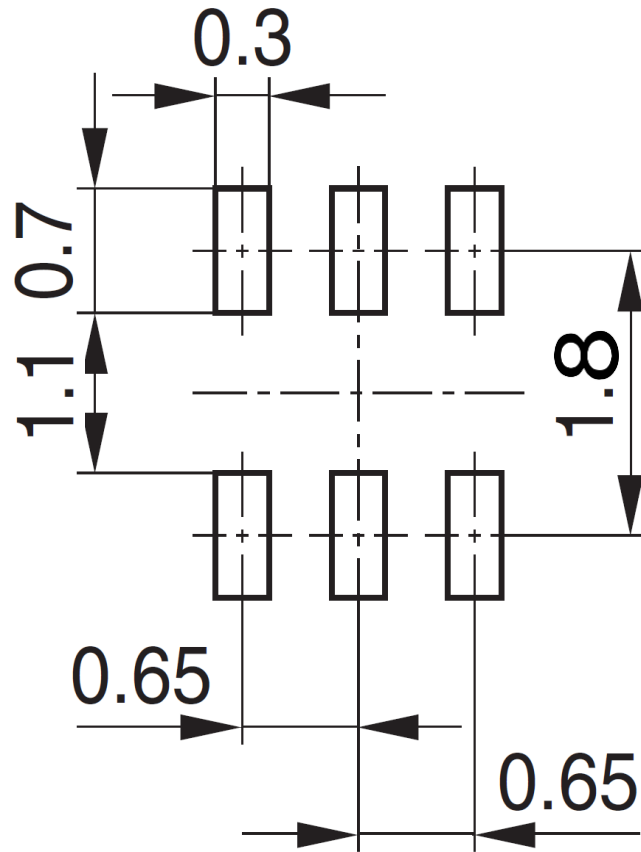
**Fig.6 Maximum Safe Operation Area**

## SOT363 Dual PACKAGE INFORMATION



Symbol	Dimensions In Millimeters		Dimensions In Inches	
	MAX	MIN	MAX	MIN
A	1.100	0.800	0.043	0.031
A1	0.100	0.000	0.004	0.000
A2	1.000	0.800	0.039	0.031
b	0.330	0.100	0.013	0.004
c	0.250	0.100	0.010	0.004
D	2.200	1.800	0.087	0.071
E	1.350	1.150	0.053	0.045
E1	2.400	1.800	0.094	0.071
e	0.65BSC		0.026BSC	
L1	0.350	0.100	0.014	0.004

### SOT363 RECOMMENDED LAND PATTERN



unit : mm