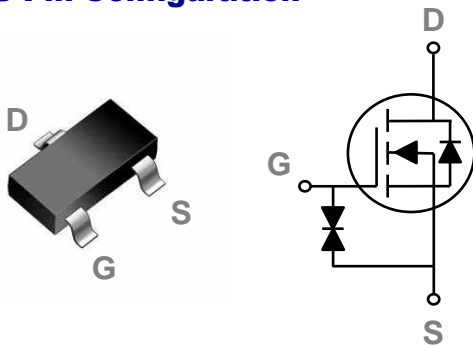


## General Description

These N-Channel enhancement mode power field effect transistors are using trench DMOS technology. This advanced technology has been especially tailored to minimize on-state resistance, provide superior switching performance, and withstand high energy pulse in the avalanche and commutation mode. These devices are well suited for high efficiency fast switching applications.

## SOT23-3S Pin Configuration



BVDSS	RDSON	ID
20V	300mΩ	1.45A

## Features

- 20V, 1.45A,  $R_{DS(ON)} = 300m\Omega @ V_{GS} = 4.5V$
- Improved  $dv/dt$  capability
- Fast switching
- Green Device Available
- Suit for 1.5V Gate Drive Applications

## Applications

- Notebook
- Load Switch
- Battery Protection
- Hand-held Instruments

## Absolute Maximum Ratings $T_c=25^\circ C$ unless otherwise noted

Symbol	Parameter	Rating	Units
$V_{DS}$	Drain-Source Voltage	20	V
$V_{GS}$	Gate-Source Voltage	$\pm 8$	V
$I_D$	Drain Current – Continuous ( $T_A=25^\circ C$ )	1.45	A
	Drain Current – Continuous ( $T_A=70^\circ C$ )	1.15	A
$I_{DM}$	Drain Current – Pulsed <sup>1</sup>	5.8	A
$P_D$	Power Dissipation ( $T_A=25^\circ C$ )	1	W
	Power Dissipation – Derate above $25^\circ C$	8	mW/ $^\circ C$
$T_{STG}$	Storage Temperature Range	-55 to 150	$^\circ C$
$T_J$	Operating Junction Temperature Range	-55 to 150	$^\circ C$

## Thermal Characteristics

Symbol	Parameter	Typ.	Max.	Unit
$R_{\theta JA}$	Thermal Resistance Junction to ambient	---	125	$^\circ C/W$

**Electrical Characteristics (T<sub>J</sub>=25 °C, unless otherwise noted)**
**Off Characteristics**

Symbol	Parameter	Conditions	Min.	Typ.	Max.	Unit
BV <sub>DSS</sub>	Drain-Source Breakdown Voltage	V <sub>GS</sub> =0V, I <sub>D</sub> =250uA	20	---	---	V
ΔBV <sub>DSS</sub> /ΔT <sub>J</sub>	BV <sub>DSS</sub> Temperature Coefficient	Reference to 25°C, I <sub>D</sub> =1mA	---	-0.01	---	V/°C
I <sub>DSS</sub>	Drain-Source Leakage Current	V <sub>DS</sub> =20V, V <sub>GS</sub> =0V, T <sub>J</sub> =25°C	---	---	1	uA
		V <sub>DS</sub> =16V, V <sub>GS</sub> =0V, T <sub>J</sub> =125°C	---	---	10	uA
I <sub>GSS</sub>	Gate-Source Leakage Current	V <sub>GS</sub> =±8V, V <sub>DS</sub> =0V	---	---	±10	uA

**On Characteristics**

R <sub>DS(ON)</sub>	Static Drain-Source On-Resistance	V <sub>GS</sub> =4.5V, I <sub>D</sub> =0.5A	---	215	300	mΩ
		V <sub>GS</sub> =2.5V, I <sub>D</sub> =0.4A	---	255	400	
		V <sub>GS</sub> =1.8V, I <sub>D</sub> =0.2A	---	315	550	
		V <sub>GS</sub> =1.5V, I <sub>D</sub> =0.1A	---	390	800	
		V <sub>GS</sub> =1.2V, I <sub>D</sub> =0.1A	---	815	1500	
V <sub>GS(th)</sub>	Gate Threshold Voltage	V <sub>GS</sub> =V <sub>DS</sub> , I <sub>D</sub> =250uA	0.3	0.6	1.0	V
ΔV <sub>GS(th)</sub>	V <sub>GS(th)</sub> Temperature Coefficient		---	3	---	mV/°C

**Dynamic and switching Characteristics**

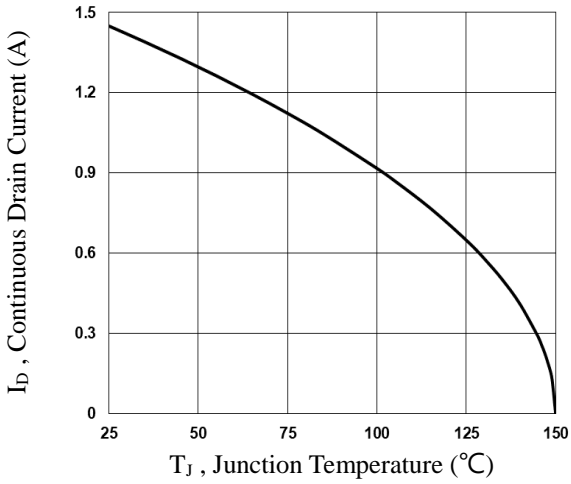
Q <sub>g</sub>	Total Gate Charge <sup>2, 3</sup>	V <sub>DS</sub> =10V, V <sub>GS</sub> =4.5V, I <sub>D</sub> =0.5A	---	1	2	nC
Q <sub>gs</sub>	Gate-Source Charge <sup>2, 3</sup>		---	0.26	0.5	
Q <sub>gd</sub>	Gate-Drain Charge <sup>2, 3</sup>		---	0.2	0.4	
T <sub>d(on)</sub>	Turn-On Delay Time <sup>2, 3</sup>	V <sub>DD</sub> =10V, V <sub>GS</sub> =4.5V, R <sub>G</sub> =10Ω I <sub>D</sub> =0.5A	---	5	10	ns
T <sub>r</sub>	Rise Time <sup>2, 3</sup>		---	3.5	7	
T <sub>d(off)</sub>	Turn-Off Delay Time <sup>2, 3</sup>		---	14	28	
T <sub>f</sub>	Fall Time <sup>2, 3</sup>		---	6	12	
C <sub>iss</sub>	Input Capacitance	V <sub>DS</sub> =10V, V <sub>GS</sub> =0V, F=1MHz	---	38.2	75	pF
C <sub>oss</sub>	Output Capacitance		---	14.4	28	
C <sub>rss</sub>	Reverse Transfer Capacitance		---	6	12	

**Drain-Source Diode Characteristics and Maximum Ratings**

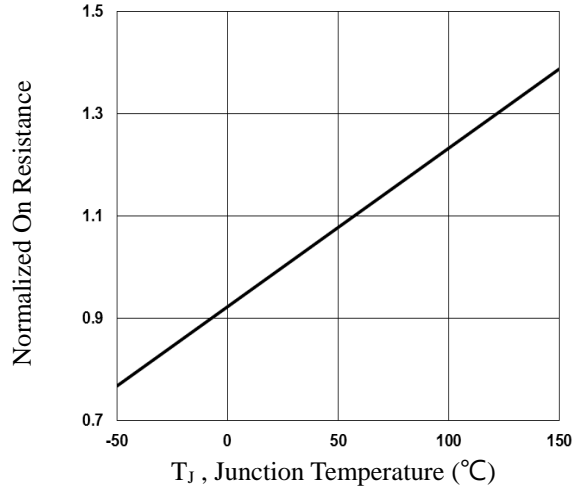
Symbol	Parameter	Conditions	Min.	Typ.	Max.	Unit
I <sub>S</sub>	Continuous Source Current	V <sub>G</sub> =V <sub>D</sub> =0V, Force Current	---	---	1.45	A
I <sub>SM</sub>	Pulsed Source Current		---	---	2.9	A
V <sub>SD</sub>	Diode Forward Voltage	V <sub>GS</sub> =0V, I <sub>S</sub> =0.2A, T <sub>J</sub> =25°C	---	---	1	V

Note :

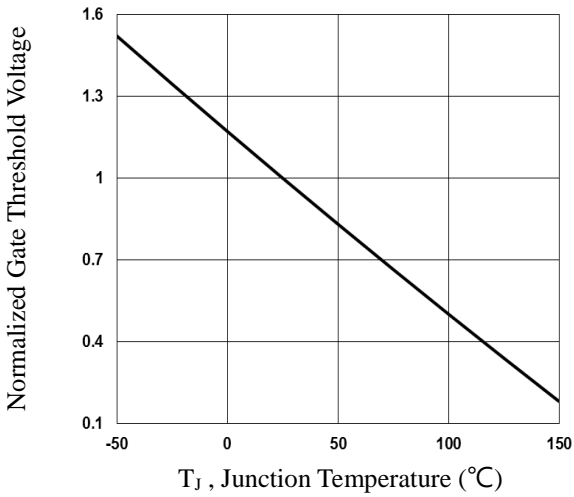
1. Repetitive Rating : Pulsed width limited by maximum junction temperature.
2. The data tested by pulsed, pulse width ≤ 300us, duty cycle ≤ 2%.
3. Essentially independent of operating temperature.



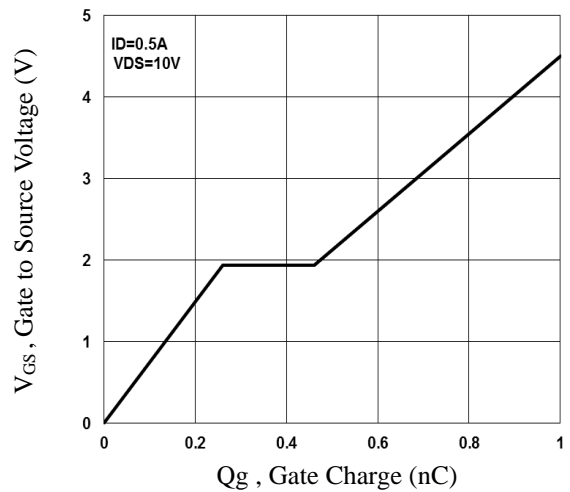
**Fig.1 Continuous Drain Current vs. T<sub>c</sub>**



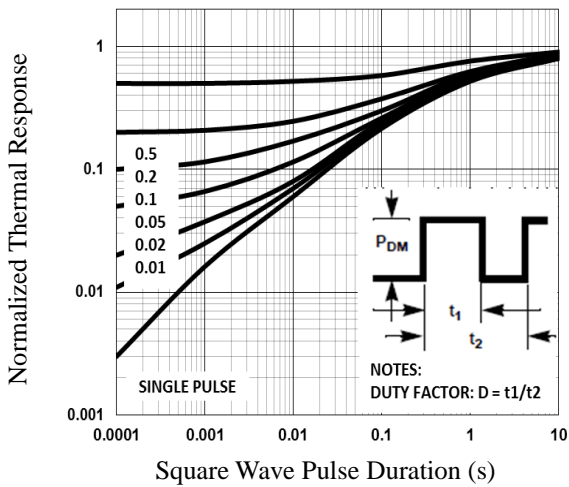
**Fig.2 Normalized R<sub>DS(on)</sub> vs. T<sub>j</sub>**



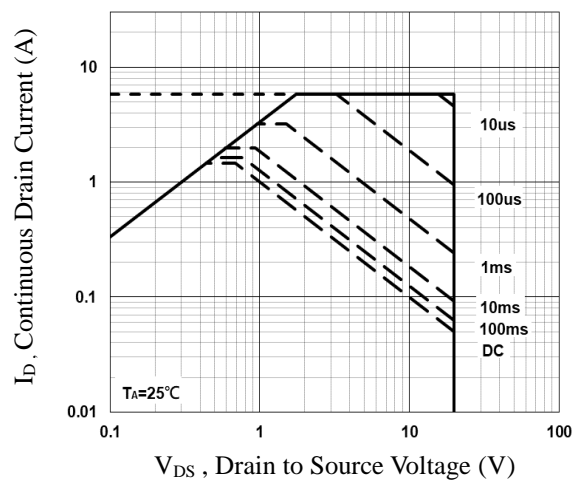
**Fig.3 Normalized V<sub>th</sub> vs. T<sub>j</sub>**



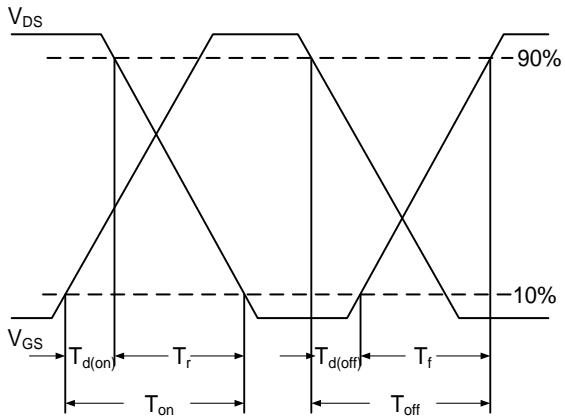
**Fig.4 Gate Charge Waveform**



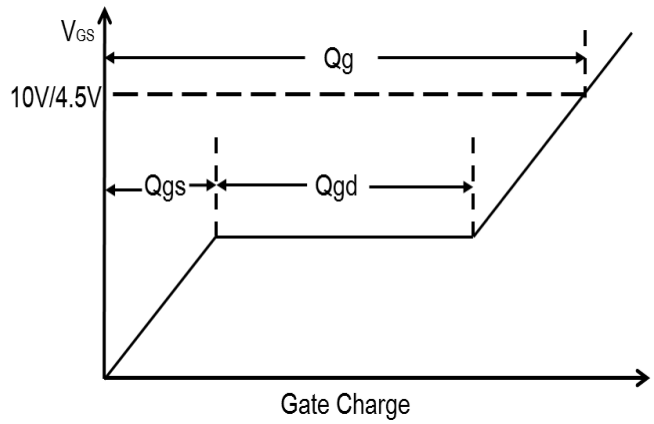
**Fig.5 Normalized Transient Response**



**Fig.6 Maximum Safe Operation Area**

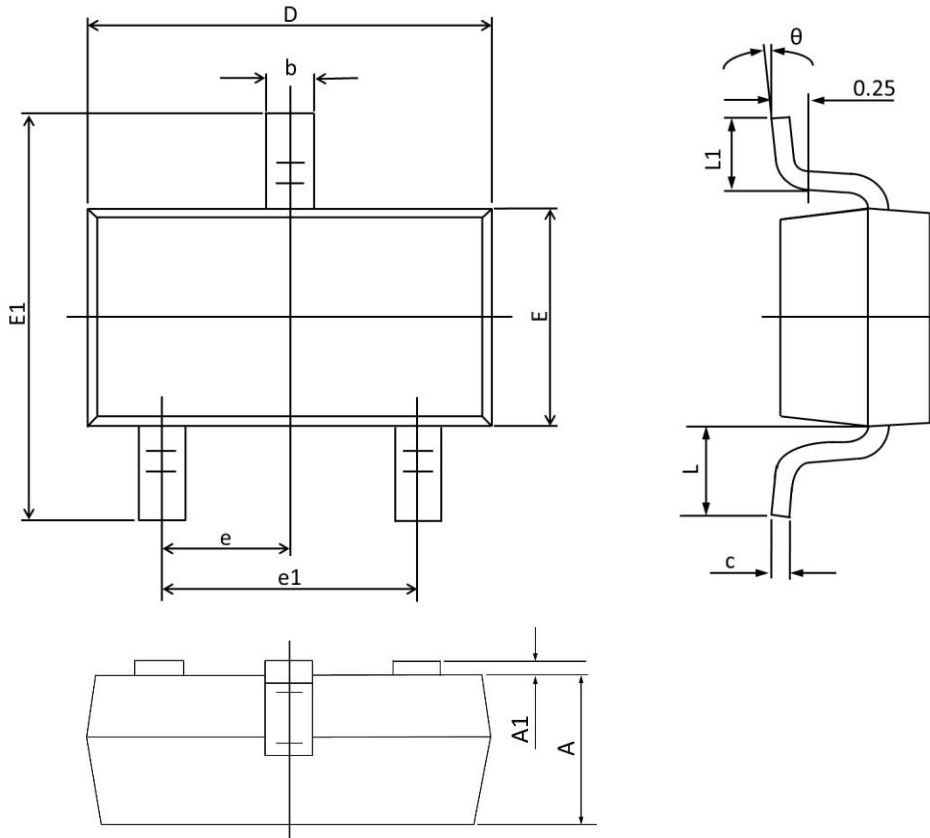


**Fig.7 Switching Time Waveform**



**Fig.8 Gate Charge Waveform**

**SOT23-3S PACKAGE INFORMATION**



Symbol	Dimensions In Millimeters		Dimensions In Inches	
	Min	Max	Min	Max
A	0.900	1.110	0.035	0.044
A1	0.001	0.100	0.000	0.004
b	0.300	0.500	0.012	0.020
c	0.080	0.180	0.003	0.008
D	2.800	3.040	0.110	0.120
E	1.200	1.400	0.047	0.055
E1	2.100	2.640	0.080	0.104
e	0.950 TYP.		0.037 TYP.	
e1	1.780	2.040	0.070	0.080
L	0.550 REF.		0.022 REF.	
L1	0.100	0.500	0.004	0.020
θ	1°	10°	1°	10°