

**General Description**

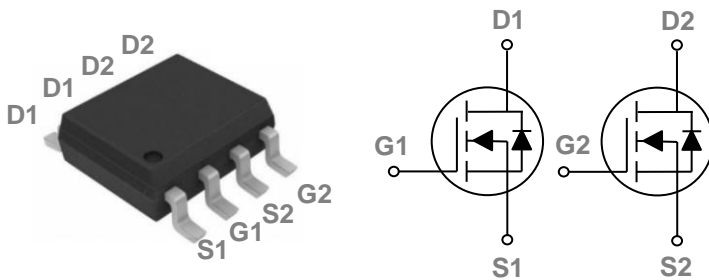
These N-Channel enhancement mode power field effect transistors are using trench DMOS technology. This advanced technology has been especially tailored to minimize on-state resistance, provide superior switching performance, and withstand high energy pulse in the avalanche and commutation mode. These devices are well suited for high efficiency fast switching applications.

BVDSS	RDSON	ID
65V	18mΩ	6A

**Features**

- 65V,6A,  $R_{DS(ON)} = 18m\Omega @ V_{GS} = 10V$
- Improved dv/dt capability
- Fast switching
- Green Device Available

**SOP8 Dual Pin Configuration**



**Applications**

- Motor Drive
- Power Tools
- LED Lighting

**Absolute Maximum Ratings**  $T_c=25^\circ C$  unless otherwise noted

Symbol	Parameter	Rating	Units
$V_{DS}$	Drain-Source Voltage	65	V
$V_{GS}$	Gate-Source Voltage	+20/-12	V
$I_D$	Drain Current – Continuous ( $T_A=25^\circ C$ )	6	A
	Drain Current – Continuous ( $T_A=70^\circ C$ )	4.8	A
$I_{DM}$	Drain Current – Pulsed <sup>1</sup>	24	A
EAS	Single Pulse Avalanche Energy <sup>2</sup>	31	mJ
IAS	Single Pulse Avalanche Current <sup>2</sup>	25	A
$P_D$	Power Dissipation ( $T_A=25^\circ C$ )	1.56	W
	Power Dissipation – Derate above 25°C	12.5	mW/°C
$T_{STG}$	Storage Temperature Range	-55 to 150	°C
$T_J$	Operating Junction Temperature Range	-55 to 150	°C

**Thermal Characteristics**

Symbol	Parameter	Typ.	Max.	Unit
$R_{\theta JA}$	Thermal Resistance Junction to ambient	---	80	°C/W

**Electrical Characteristics (T<sub>J</sub>=25 °C, unless otherwise noted)**
**Off Characteristics**

Symbol	Parameter	Conditions	Min.	Typ.	Max.	Unit
BV <sub>DSS</sub>	Drain-Source Breakdown Voltage	V <sub>GS</sub> =0V, I <sub>D</sub> =250uA	65	---	---	V
I <sub>DSS</sub>	Drain-Source Leakage Current	V <sub>DS</sub> =60V, V <sub>GS</sub> =0V, T <sub>J</sub> =25°C	---	---	1	uA
		V <sub>DS</sub> =48V, V <sub>GS</sub> =0V, T <sub>J</sub> =85°C	---	---	10	uA
I <sub>GSS</sub>	Gate-Source Leakage Current	V <sub>GS</sub> =+20V, V <sub>DS</sub> =0V	---	---	100	nA

**On Characteristics**

R <sub>DS(ON)</sub>	Static Drain-Source On-Resistance	V <sub>GS</sub> =10V, I <sub>D</sub> =2A	---	15	18	mΩ
		V <sub>GS</sub> =4.5V, I <sub>D</sub> =1.5A	---	23.5	30.5	mΩ
V <sub>GS(th)</sub>	Gate Threshold Voltage	V <sub>GS</sub> =V <sub>DS</sub> , I <sub>D</sub> =250uA	1.2	1.6	2.5	V
g <sub>fs</sub>	Forward Transconductance	V <sub>DS</sub> =10V, I <sub>D</sub> =1A	---	3	---	S

**Dynamic and switching Characteristics**

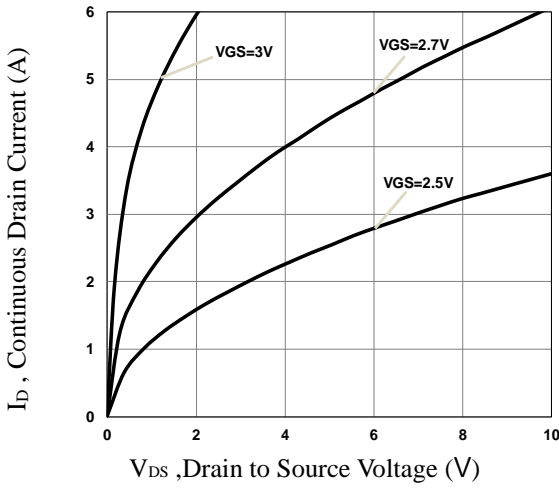
Q <sub>g</sub>	Total Gate Charge <sup>3, 4</sup>	V <sub>DS</sub> =30V, V <sub>GS</sub> =10V, I <sub>D</sub> =3A	---	10.9	17	nC
Q <sub>gs</sub>	Gate-Source Charge <sup>3, 4</sup>		---	1.5	2.3	
Q <sub>gd</sub>	Gate-Drain Charge <sup>3, 4</sup>		---	4.4	6.5	
T <sub>d(on)</sub>	Turn-On Delay Time <sup>3, 4</sup>	V <sub>DD</sub> =30V, V <sub>GS</sub> =10V, R <sub>G</sub> =6Ω I <sub>D</sub> =3A	---	8	16	ns
T <sub>r</sub>	Rise Time <sup>3, 4</sup>		---	12	24	
T <sub>d(off)</sub>	Turn-Off Delay Time <sup>3, 4</sup>		---	25	50	
T <sub>f</sub>	Fall Time <sup>3, 4</sup>		---	18	36	
C <sub>iss</sub>	Input Capacitance	V <sub>DS</sub> =30V, V <sub>GS</sub> =0V, F=1MHz	---	655	985	pF
C <sub>oss</sub>	Output Capacitance		---	190	285	
C <sub>rss</sub>	Reverse Transfer Capacitance		---	27	40	
R <sub>g</sub>	Gate resistance	V <sub>GS</sub> =0V, V <sub>DS</sub> =0V, f=1MHz	---	0.8	---	Ω

**Drain-Source Diode Characteristics and Maximum Ratings**

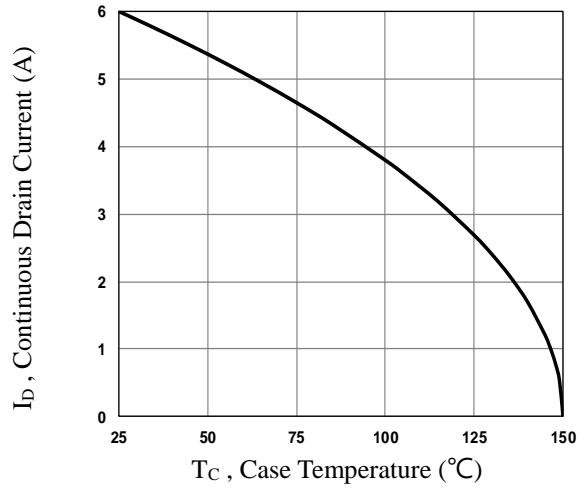
Symbol	Parameter	Conditions	Min.	Typ.	Max.	Unit
I <sub>S</sub>	Continuous Source Current	V <sub>G</sub> =V <sub>D</sub> =0V, Force Current	---	---	6	A
I <sub>SM</sub>	Pulsed Source Current		---	---	12	A
V <sub>SD</sub>	Diode Forward Voltage	V <sub>GS</sub> =0V, I <sub>S</sub> =1A, T <sub>J</sub> =25°C	---	---	1	V
t <sub>rr</sub>	Reverse Recovery Time <sup>3</sup>	V <sub>R</sub> =50V, I <sub>S</sub> =10A	---	30	---	ns
Q <sub>rr</sub>	Reverse Recovery Charge <sup>3</sup>		di/dt=100A/μs, T <sub>J</sub> =25°C	---	15	---

Note :

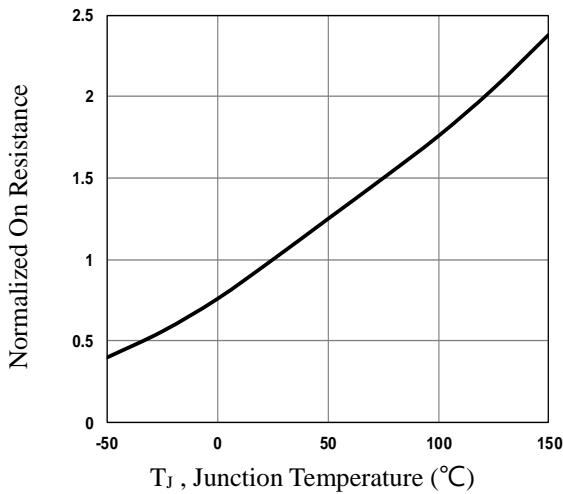
1. Repetitive Rating : Pulsed width limited by maximum junction temperature.
2. V<sub>DD</sub>=25V, V<sub>GS</sub>=10V, L=0.1mH, I<sub>AS</sub>=25A., R<sub>G</sub>=25Ω, Starting T<sub>J</sub>=25°C.
3. The data tested by pulsed, pulse width ≤ 300us, duty cycle ≤ 2%.
4. Essentially independent of operating temperature.



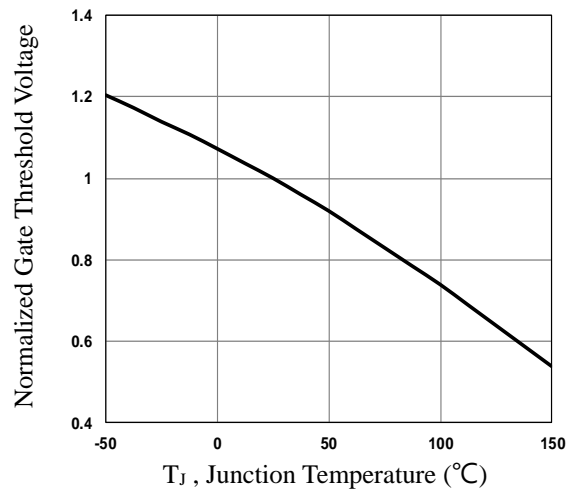
**Fig.1 Typical Output Characteristics**



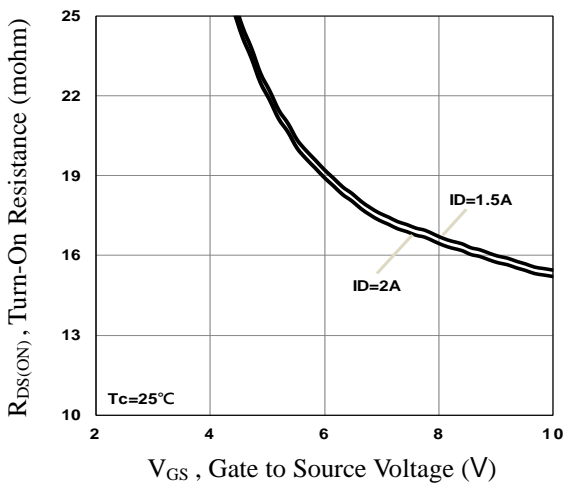
**Fig.2 Continuous Drain Current vs. T<sub>c</sub>**



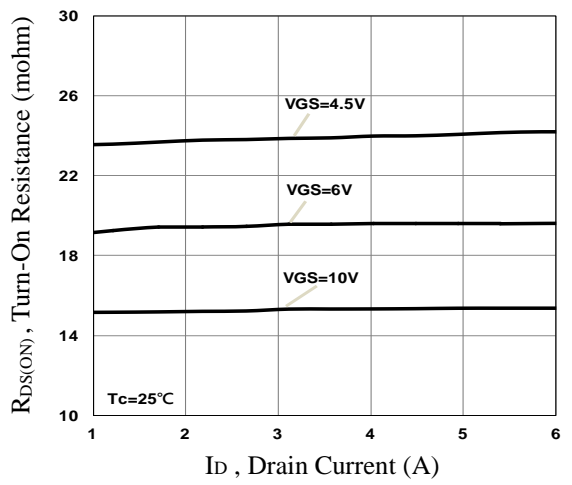
**Fig.3 Normalized R<sub>DS(on)</sub> vs. T<sub>J</sub>**



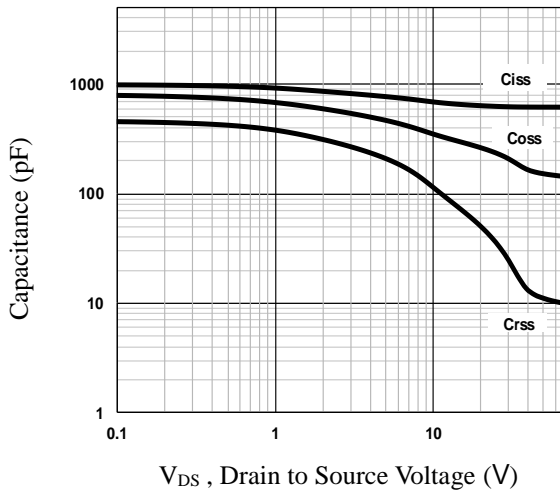
**Fig.4 Normalized V<sub>th</sub> vs. T<sub>J</sub>**



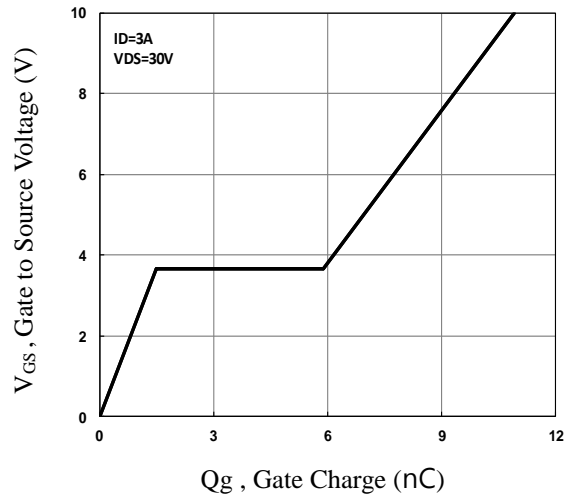
**Fig.5 Turn-On Resistance vs. V<sub>GS</sub>**



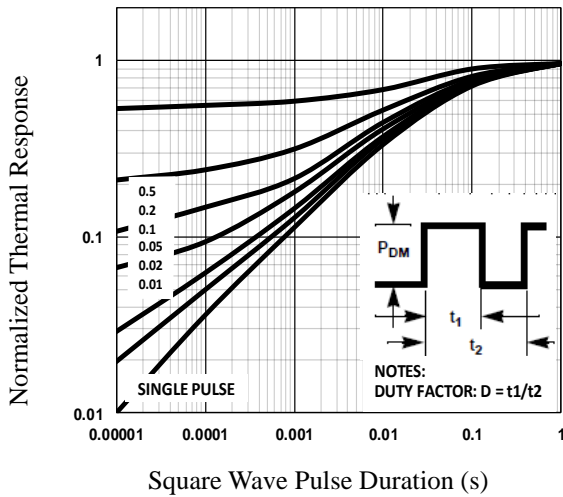
**Fig.6 Turn-On Resistance vs. I<sub>D</sub>**



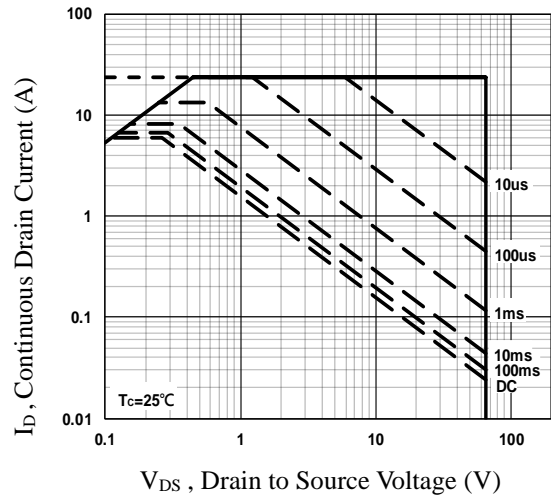
**Fig.7 Capacitance Characteristics**



**Fig.8 Gate Charge Characteristics**



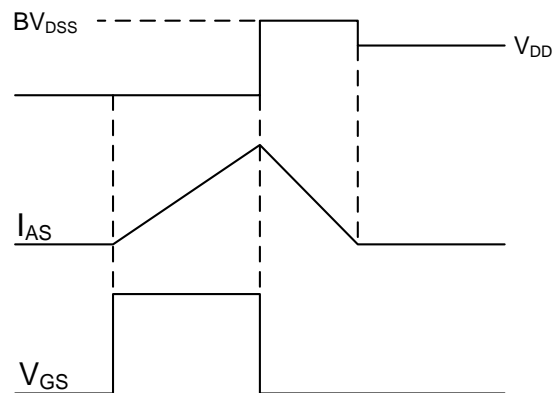
**Fig.9 Normalized Transient Impedance**



**Fig.10 Maximum Safe Operation Area**

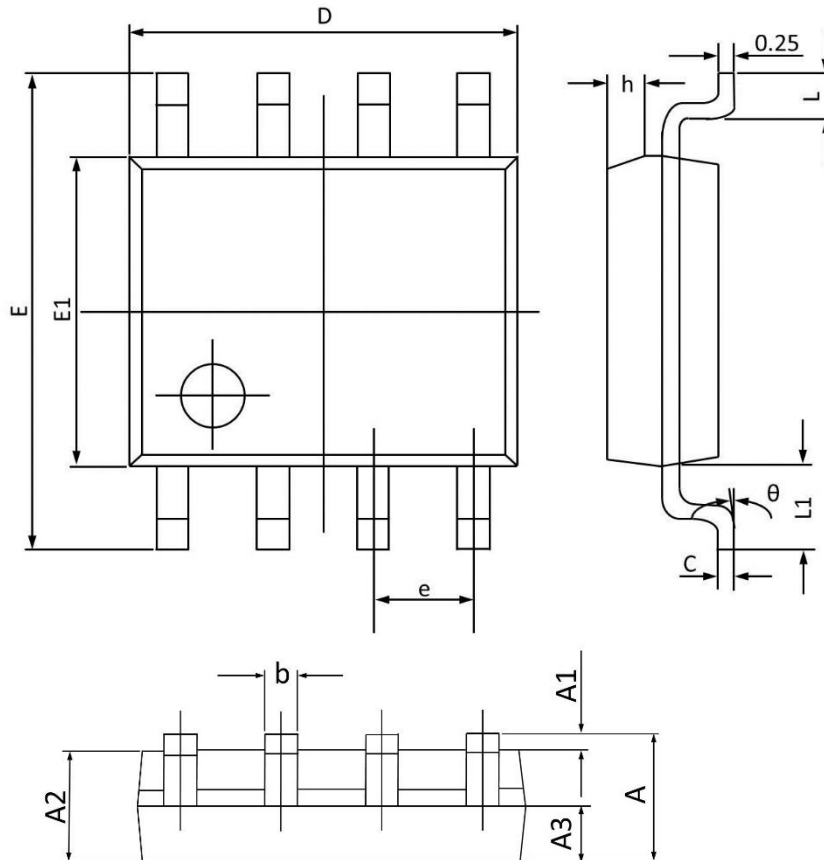


**Fig.11 Switching Time Waveform**



**Fig.12 EAS Waveform**

## SOP8 PACKAGE INFORMATION



Symbol	Dimensions In Millimeters		Dimensions In Inches	
	Min	Max	Min	Max
A	1.350	1.800	0.053	0.069
A1	0.050	0.250	0.002	0.010
A2	1.250	1.650	0.049	0.065
A3	0.500	0.700	0.020	0.028
b	0.300	0.510	0.012	0.020
c	0.150	0.260	0.006	0.010
D	4.700	5.100	0.185	0.201
E	5.800	6.200	0.228	0.244
E1	3.700	4.100	0.146	0.161
e	1.270(BSC)		0.050(BSC)	
h	0.250	0.500	0.010	0.020
L	0.400	1.000	0.016	0.039
L1	1.050(BSC)		0.041(BSC)	
θ	0°	8°	0°	8°