

**General Description**

These N-Channel enhancement mode power field effect transistors are using trench DMOS technology. This advanced technology has been especially tailored to minimize on-state resistance, provide superior switching performance, and withstand high energy pulse in the avalanche and commutation mode. These devices are well suited for high efficiency fast switching applications.

BVDSS	RDSON	ID
65V	5.3mΩ	14A

**Features**

- 65V, 14A,  $R_{DS(ON)} = 5.3m\Omega @ V_{GS} = 10V$
- Improved  $dv/dt$  capability
- Fast switching
- 100% EAS Guaranteed
- Green Device Available

**SOP8 Pin Configuration**

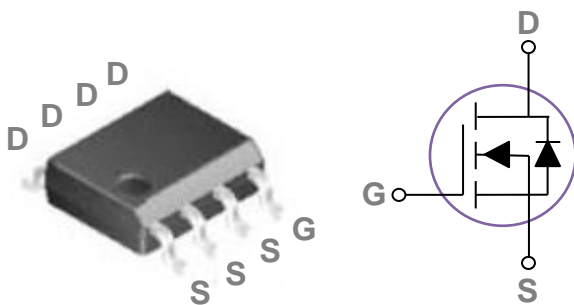

**Applications**

- Networking
- Load Switch
- LED applications

**Absolute Maximum Ratings**  $T_c=25^\circ C$  unless otherwise noted

Symbol	Parameter	Rating	Units
$V_{DS}$	Drain-Source Voltage	65	V
$V_{GS}$	Gate-Source Voltage	$\pm 20$	V
$I_D$	Drain Current – Continuous ( $T_A=25^\circ C$ )	14	A
	Drain Current – Continuous ( $T_A=70^\circ C$ )	11.2	A
$I_{DM}$	Drain Current – Pulsed <sup>1</sup>	56	A
EAS	Single Pulse Avalanche Energy <sup>2</sup>	140	mJ
IAS	Single Pulse Avalanche Current <sup>2</sup>	53	A
$P_D$	Power Dissipation ( $T_A=25^\circ C$ )	2	W
	Power Dissipation – Derate above $25^\circ C$	0.016	W/ $^\circ C$
$T_{STG}$	Storage Temperature Range	-50 to 150	$^\circ C$
$T_J$	Operating Junction Temperature Range	-50 to 150	$^\circ C$

**Thermal Characteristics**

Symbol	Parameter	Typ.	Max.	Unit
$R_{\theta JA}$	Thermal Resistance Junction to ambient	---	62.5	$^\circ C/W$

**Electrical Characteristics (T<sub>J</sub>=25 °C, unless otherwise noted)**
**Off Characteristics**

Symbol	Parameter	Conditions	Min.	Typ.	Max.	Unit
BV <sub>DSS</sub>	Drain-Source Breakdown Voltage	V <sub>GS</sub> =0V, I <sub>D</sub> =250μA	65	---	---	V
I <sub>DSS</sub>	Drain-Source Leakage Current	V <sub>DS</sub> =60V, V <sub>GS</sub> =0V, T <sub>J</sub> =25°C	---	---	1	μA
		V <sub>DS</sub> =48V, V <sub>GS</sub> =0V, T <sub>J</sub> =85°C	---	---	10	μA
I <sub>GSS</sub>	Gate-Source Leakage Current	V <sub>GS</sub> =±20V, V <sub>DS</sub> =0V	---	---	±100	nA

**On Characteristics**

R <sub>DS(ON)</sub>	Static Drain-Source On-Resistance	V <sub>GS</sub> =10V, I <sub>D</sub> =8A	---	4.4	5.3	mΩ
		V <sub>GS</sub> =4.5V, I <sub>D</sub> =6A	---	6.5	8.4	mΩ
V <sub>GS(th)</sub>	Gate Threshold Voltage	V <sub>GS</sub> =V <sub>DS</sub> , I <sub>D</sub> =250μA	1.2	1.6	2.5	V
g <sub>fs</sub>	Forward Transconductance	V <sub>DS</sub> =10V, I <sub>D</sub> =3A	---	10	---	S

**Dynamic and switching Characteristics**

Q <sub>g</sub>	Total Gate Charge <sup>3,4</sup>	V <sub>DS</sub> =48V, V <sub>GS</sub> =10V, I <sub>D</sub> =10A	---	36	54	nC
Q <sub>gs</sub>	Gate-Source Charge <sup>3,4</sup>		---	4.7	7.1	
Q <sub>gd</sub>	Gate-Drain Charge <sup>3,4</sup>		---	13.5	20	
T <sub>d(on)</sub>	Turn-On Delay Time <sup>3,4</sup>	V <sub>DD</sub> =48V, V <sub>GS</sub> =10V, R <sub>G</sub> =6Ω I <sub>D</sub> =1A	---	10.2	15	ns
T <sub>r</sub>	Rise Time <sup>3,4</sup>		---	16	24	
T <sub>d(off)</sub>	Turn-Off Delay Time <sup>3,4</sup>		---	42	63	
T <sub>f</sub>	Fall Time <sup>3,4</sup>		---	38	57	
C <sub>iss</sub>	Input Capacitance	V <sub>DS</sub> =48V, V <sub>GS</sub> =0V, F=1MHz	---	1675	2510	pF
C <sub>oss</sub>	Output Capacitance		---	322	485	
C <sub>rss</sub>	Reverse Transfer Capacitance		---	14	25	
R <sub>g</sub>	Gate resistance	V <sub>GS</sub> =0V, V <sub>DS</sub> =0V, F=1MHz	---	1.2	---	Ω

**Drain-Source Diode Characteristics and Maximum Ratings**

Symbol	Parameter	Conditions	Min.	Typ.	Max.	Unit
I <sub>S</sub>	Continuous Source Current	V <sub>G</sub> =V <sub>D</sub> =0V, Force Current	---	---	14	A
I <sub>SM</sub>	Pulsed Source Current		---	---	28	A
V <sub>SD</sub>	Diode Forward Voltage	V <sub>GS</sub> =0V, I <sub>S</sub> =1A, T <sub>J</sub> =25°C	---	---	1	V
t <sub>rr</sub>	Reverse Recovery Time	V <sub>R</sub> =50V, I <sub>S</sub> =10A	---	54	---	ns
Q <sub>rr</sub>	Reverse Recovery Charge	di/dt=100A/μs, T <sub>J</sub> =25°C	---	67	---	nC

Note :

1. Repetitive Rating : Pulsed width limited by maximum junction temperature.
2. V<sub>DD</sub>=25V, V<sub>GS</sub>=10V, L=0.1mH, I<sub>AS</sub>=53A., R<sub>G</sub>=25Ω, Starting T<sub>J</sub>=25°C.
3. The data tested by pulsed, pulse width ≤ 300us, duty cycle ≤ 2%.
4. Essentially independent of operating temperature.

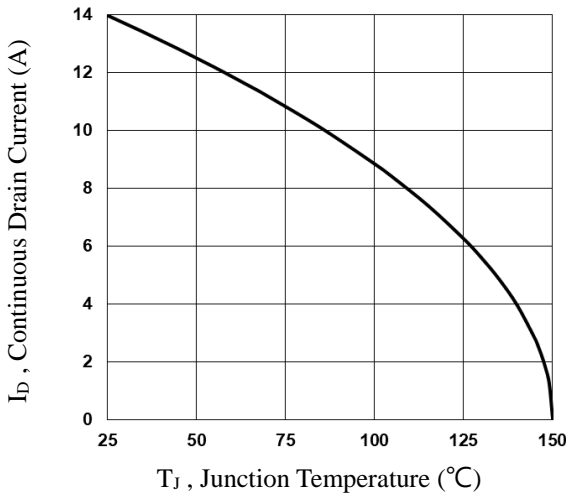

**Fig.1 Continuous Drain Current vs.  $T_J$**

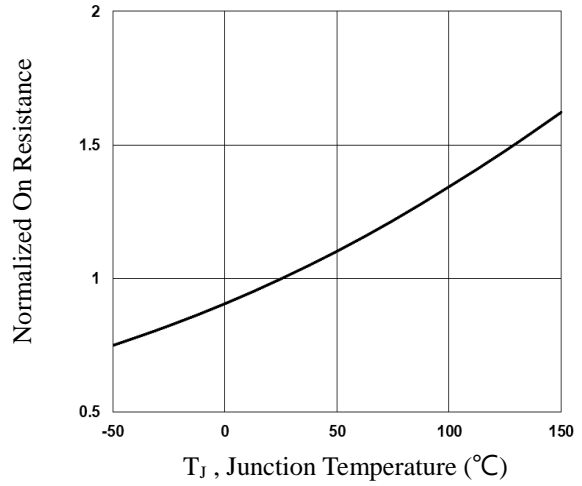

**Fig.2 Normalized  $R_{DS(on)}$  vs.  $T_J$**

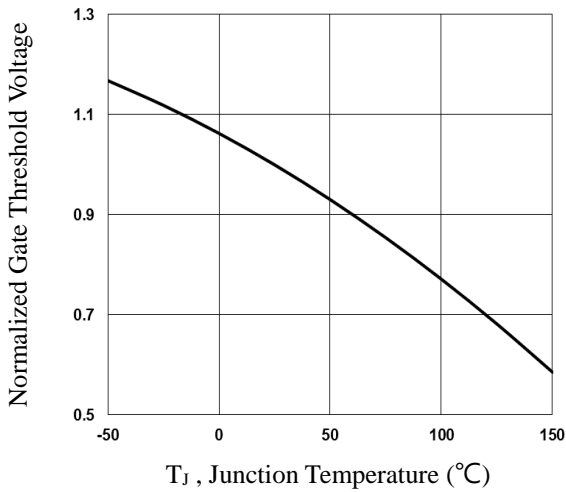

**Fig.3 Normalized  $V_{th}$  vs.  $T_J$**

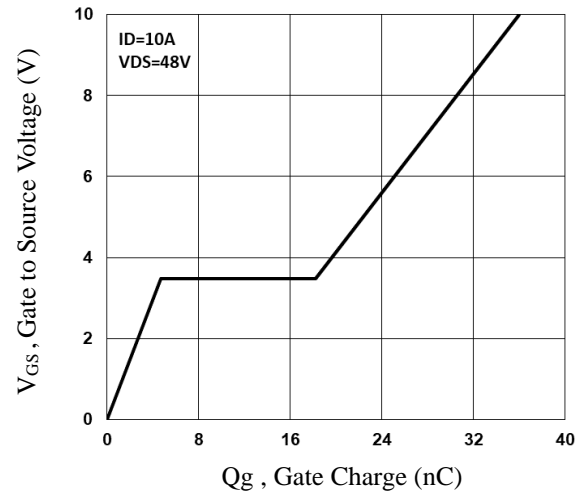

**Fig.4 Gate Charge Characteristics**

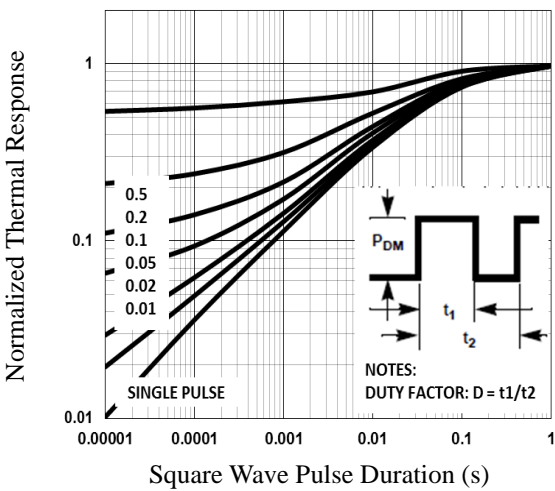

**Fig.5 Normalized Transient Impedance**

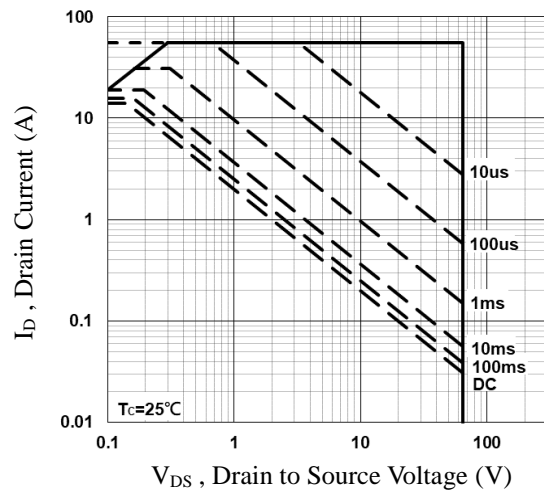

**Fig.6 Maximum Safe Operation Area**

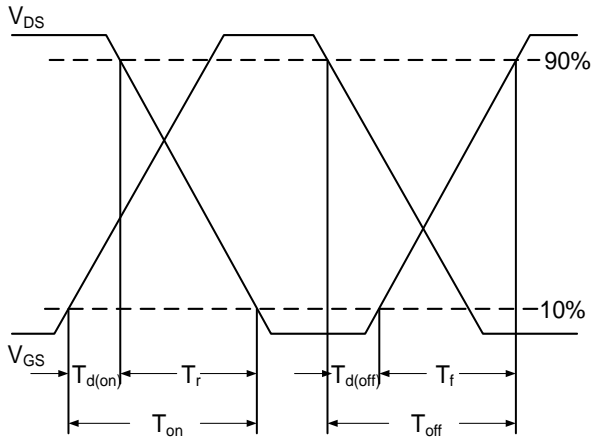
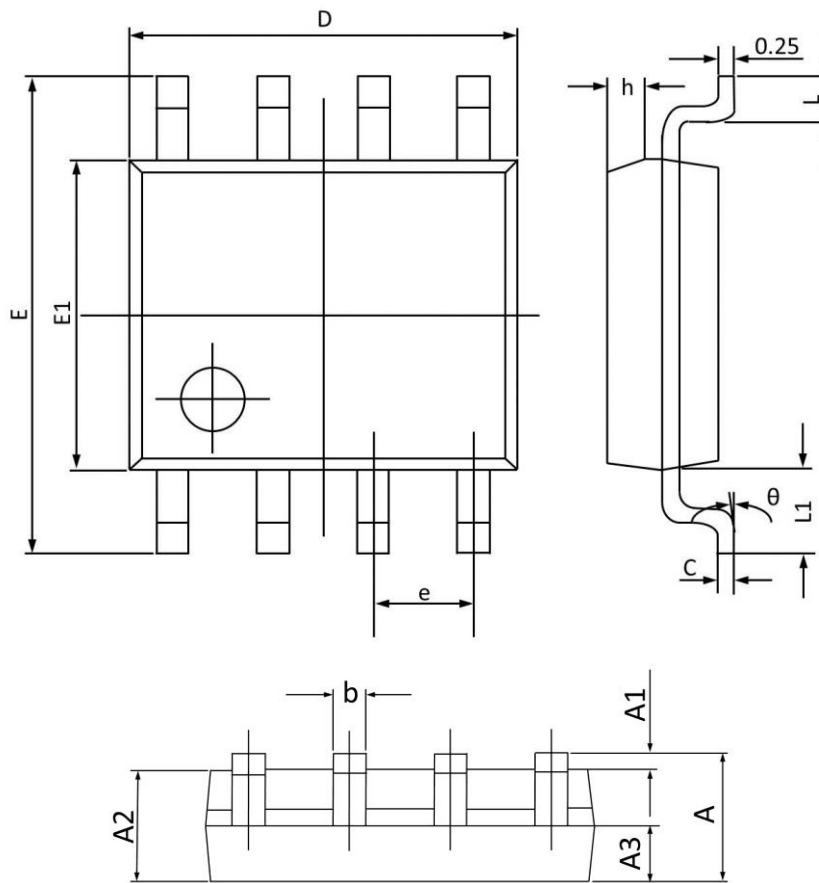

**Fig.7 Switching Time Waveform**



**Fig.8 Gate Charge Waveform**

## SOP8 PACKAGE INFORMATION



Symbol	Dimensions In Millimeters		Dimensions In Inches	
	Min	Max	Min	Max
A	1.350	1.750	0.053	0.068
A1	0.100	0.250	0.004	0.009
A2	1.300	1.500	0.052	0.059
A3	0.600	0.700	0.024	0.027
b	0.390	0.480	0.016	0.018
c	0.210	0.260	0.009	0.010
D	4.700	5.100	0.186	0.200
E	5.800	6.200	0.229	0.244
E1	3.700	4.100	0.146	0.161
e	1.270(BSC)		0.050(BSC)	
h	0.250	0.500	0.010	0.019
L	0.500	0.800	0.019	0.031
L1	1.050(BSC)		0.041(BSC)	
$\theta$	0°	8°	0°	8°