

General Description

The x485 are low-power transceivers for RS-485 and RS-422 communication. Each part contains one driver and one Receiver. The driver slew rates of the x485 are not limited, allowing them to transmit up to 2.5Mbps. These transceivers draw between 120µA and 500µA of supply current when unloaded or fully loaded with disabled

Applications

Low-Power RS-485 Transceivers
Low-Power RS-422 Transceivers
Level Translators
Transceivers for EMI-Sensitive Applications
Industrial-Control Local Area Networks

ABSOLUTE MAXIMUM RATINGS

Supply Voltage (V _{CC}).....	12V	8-Pin µMAX (derate 4.1mW/°C above +70°C)	830mW
Control Input Voltage (\overline{RE} , DE).....	-0.5V to (V _{CC} + 0.5V)	8-Pin Cerdip (derate 8.00mW/°C above +70°C).....	640mW
Driver Input Voltage (DI).....	-0.5V to (V _{CC} + 0.5V)	Operating Temperature Ranges	
Driver Output Voltage (A, B).....	-8V to +12.5V	Storage Temperature Range	-65°C to +160°C
Receiver Input Voltage (A, B).....	-8V to +12.5V	Lead Temperature (soldering, 10sec)	+300°C
Receiver Output Voltage (RO).....	-0.5V to (V _{CC} + 0.5V)		
Continuous Power Dissipation (T _A = +70°C)			
8-Pin Plastic DIP (derate 9.09mW/°C above +70°C)	727mW		
8-Pin SO (derate 5.88mW/°C above +70°C).....	471mW		

Stresses beyond those listed under "Absolute Maximum Ratings" may cause permanent damage to the device. These are stress ratings only, and functional operation of the device at these or any other conditions beyond those indicated in the operational sections of the specifications is not implied. Exposure to absolute maximum rating conditions for extended periods may affect device reliability.

DC ELECTRICAL CHARACTERISTICS

(V_{CC} = 5V ±5%, T_A = T_{MIN} to T_{MAX}, unless otherwise noted.) (Notes 1, 2)

PARAMETER	SYMBOL	CONDITIONS	MIN	TYP	MAX	UNITS
Differential Driver Output (no load)	V _{OD1}				5	V
Differential Driver Output (with load)	V _{OD2}	R = 50Ω (RS-422)	2			V
		R = 27Ω (RS-485), Figure 4	1.5		5	
Change in Magnitude of Driver Differential Output Voltage for Complementary Output States	ΔV _{OD}	R = 27Ω or 50Ω, Figure 4			0.2	V
Driver Common-Mode Output Voltage	V _{OC}	R = 27Ω or 50Ω, Figure 4			3	V
Change in Magnitude of Driver Common-Mode Output Voltage for Complementary Output States	ΔV _{OD}	R = 27Ω or 50Ω, Figure 4			0.2	V
Input High Voltage	V _{IH}	DE, DI, \overline{RE}	2.0			V
Input Low Voltage	V _{IL}	DE, DI, \overline{RE}			0.8	V
Input Current	I _{IN1}	DE, DI, \overline{RE}			±2	µA
Receiver Differential Threshold Voltage	V _{TH}	-7V ≤ V _{CM} ≤ 12V	-0.2		0.2	V
Receiver Input Hysteresis	ΔV _{TH}	V _{CM} = 0V		70		mV
Receiver Output High Voltage	V _{OH}	I _O = -4mA, V _{ID} = 200mV	3.5			V
Receiver Output Low Voltage	V _{OL}	I _O = 4mA, V _{ID} = -200mV			0.4	V
Three-State (high impedance) Output Current at Receiver	I _{OZR}	0.4V ≤ V _O ≤ 2.4V			±1	µA

XL485-SS MSOP8
 XL485CS SOP8
 XD485 DIP-8
 RS-485/RS422

DC ELECTRICAL CHARACTERISTICS (continued)

($V_{CC} = 5V \pm 5\%$, $T_A = T_{MIN}$ to T_{MAX} , unless otherwise noted.) (Notes 1, 2)

PARAMETER	SYMBOL	CONDITIONS		MIN	TYP	MAX	UNITS
No-Load Supply Current (Note 3)	I_{CC}	485 $\overline{RE} = 0V$ or V_{CC}	$DE = V_{CC}$		500	900	μA
			$DE = 0V$		300	500	
Driver Short-Circuit Current, $V_O = High$	I_{OSD1}	$-7V \leq V_O \leq 12V$ (Note 4)		35		250	mA
Driver Short-Circuit Current, $V_O = Low$	I_{OSD2}	$-7V \leq V_O \leq 12V$ (Note 4)		35		250	mA
Receiver Short-Circuit Current	I_{OSR}	$0V \leq V_O \leq V_{CC}$		7		95	mA

SWITCHING CHARACTERISTICS—485

($V_{CC} = 5V \pm 5\%$, $T_A = T_{MIN}$ to T_{MAX} , unless otherwise noted.) (Notes 1, 2)

PARAMETER	SYMBOL	CONDITIONS		MIN	TYP	MAX	UNITS
Driver Input to Output	t_{PLH}	$R_{DIFF} = 54\Omega$, $C_{L1} = C_{L2} = 100pF$	485	10	30	60	ns
	t_{PHL}			10	30	60	
Driver Output Skew to Output	t_{SKEW}	$R_{DIFF} = 54\Omega$, $C_{L1} = C_{L2} = 100pF$			5	10	ns
Driver Rise or Fall Time	t_R , t_F	Figures 6 and 8, $R_{DIFF} = 54\Omega$, $C_{L1} = C_{L2} = 100pF$	485	3	15	40	ns
Driver Enable to Output High	t_{ZH}	$C_L = 100pF$, S2 closed			40	70	ns
Driver Enable to Output Low	t_{ZL}	$C_L = 100pF$, S1 closed			40	70	ns
Driver Disable Time from Low	t_{LZ}	$C_L = 15pF$, S1 closed			40	70	ns
Driver Disable Time from High	t_{HZ}	$C_L = 15pF$, S2 closed			40	70	ns
Receiver Input to Output	t_{PLH} , t_{PHL}	$R_{DIFF} = 54\Omega$, $C_{L1} = C_{L2} = 100pF$	485	20	90	200	ns
$ t_{PLH} - t_{PHL} $ Differential Receiver Skew	t_{SKD}	$R_{DIFF} = 54\Omega$, $C_{L1} = C_{L2} = 100pF$			13		ns
Receiver Enable to Output Low	t_{ZL}	$C_{RL} = 15pF$, S1 closed			20	50	ns
Receiver Enable to Output High	t_{ZH}	$C_{RL} = 15pF$, S2 closed			20	50	ns
Receiver Disable Time from Low	t_{LZ}	$C_{RL} = 15pF$, S1 closed			20	50	ns
Receiver Disable Time from High	t_{HZ}	$C_{RL} = 15pF$, S2 closed			20	50	ns
Maximum Data Rate	f_{MAX}			2.5			Mbps

XL485-SS MSOP8
 XL485CS SOP8
 XD485 DIP-8
 RS-485/RS422

NOTES FOR ELECTRICAL/SWITCHING CHARACTERISTICS

- Note 1:** All currents into device pins are positive; all currents out of device pins are negative. All voltages are referenced to device ground unless otherwise specified.
- Note 2:** All typical specifications are given for $V_{CC} = 5V$ and $T_A = +25^\circ C$.
- Note 3:** Supply current specification is valid for loaded transmitters when $DE = 0V$.
- Note 4:** Applies to peak current. See *Typical Operating Characteristics*.

Typical Operating Characteristics

($V_{CC} = 5V$, $T_A = +25^\circ C$, unless otherwise noted.)

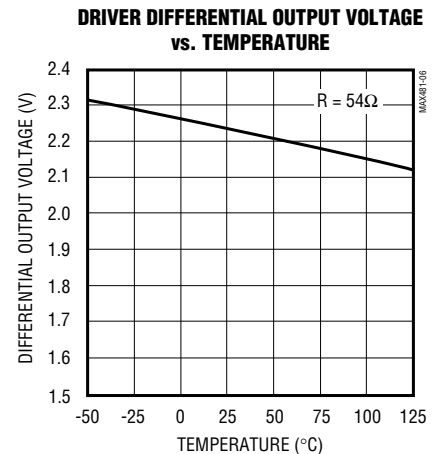
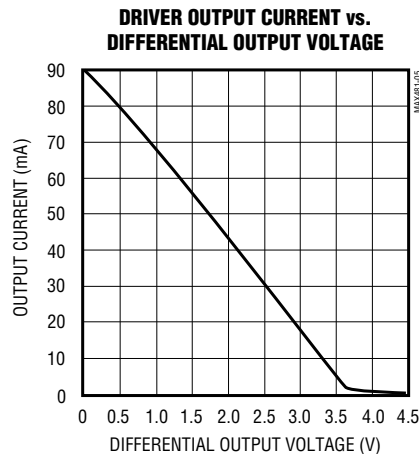
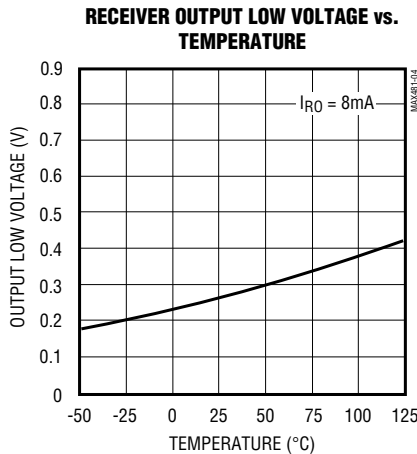
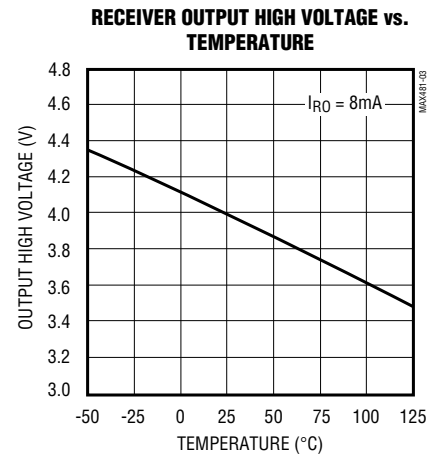
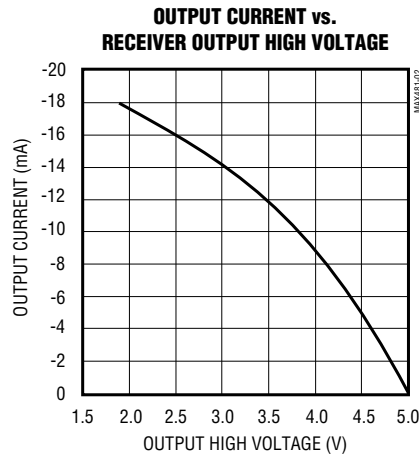
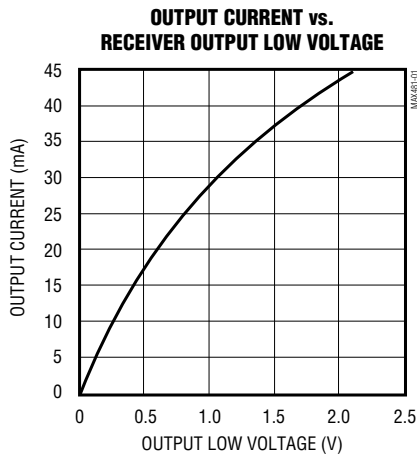

Typical Operating Characteristics (continued)

($V_{CC} = 5V$, $T_A = +25^\circ C$, unless otherwise noted.)

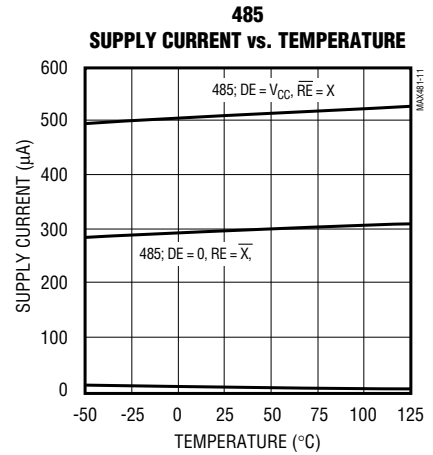
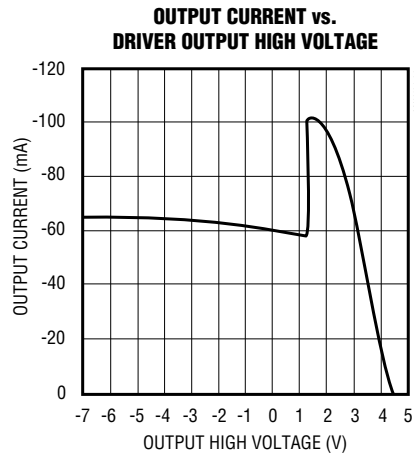
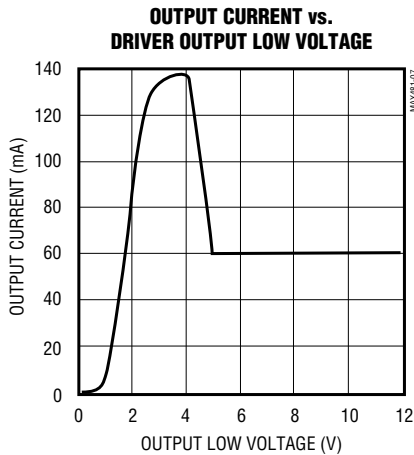

Pin Description

PIN		NAME	FUNCTION
485			
DIP/SOP MSOP	µMAX		
1	3	RO	Receiver Output: If $A > B$ by 200mV, RO will be high; If $A < B$ by 200mV, RO will be low.
2	4	\overline{RE}	Receiver Output Enable. RO is enabled when \overline{RE} is low; RO is high impedance when \overline{RE} is high.
3	5	DE	Driver Output Enable. The driver outputs, Y and Z, are enabled by bringing DE high. They are high impedance when DE is low. If the driver outputs are enabled, the parts function as line drivers. While they are high impedance, they function as line receivers if \overline{RE} is low.
4	6	DI	Driver Input. A low on DI forces output Y low and output Z high. Similarly, a high on DI forces output Y high and output Z low.
5	7	GND	Ground
—	—	Y	Noninverting Driver Output
—	—	Z	Inverting Driver Output
6	8	A	Noninverting Receiver Input and Noninverting Driver Output
—	—	A	Noninverting Receiver Input
7	1	B	Inverting Receiver Input and Inverting Driver Output
—	—	B	Inverting Receiver Input
8	2	VCC	Positive Supply: $4.75V \leq V_{CC} \leq 5.25V$
—	—	N.C.	No Connect—not internally connected

XL485-SS MSOP8
 XL485CS SOP8
 XD485 DIP-8
 RS-485/RS422

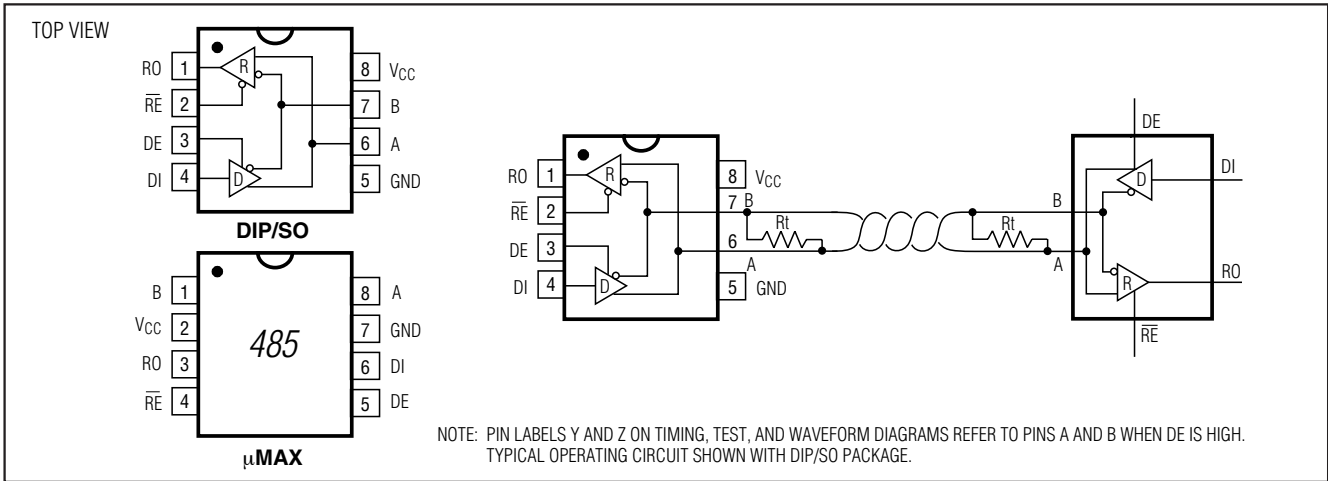

485 Pin Configuration and Typical Operating Circuit

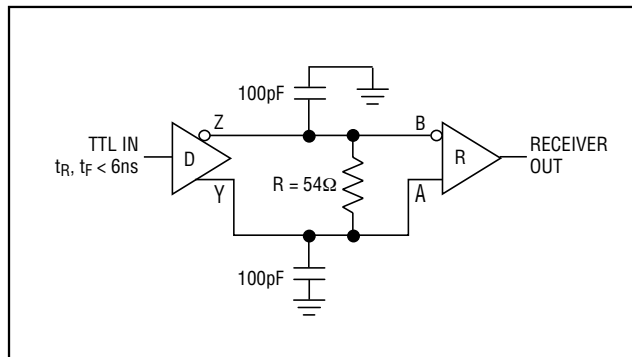

Receiver Propagation Delay Test Circuit

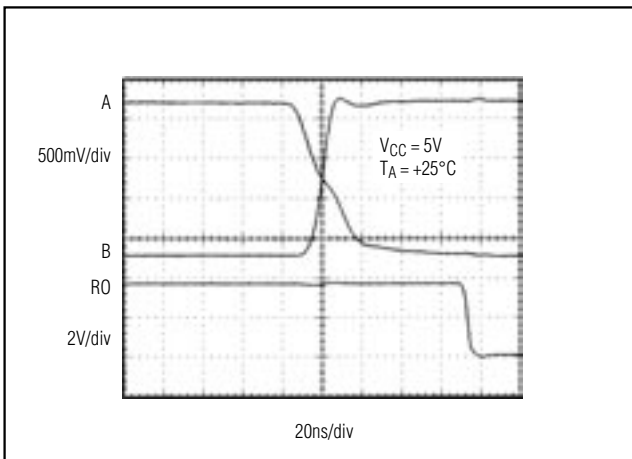

485 Receiver t_{PHL}

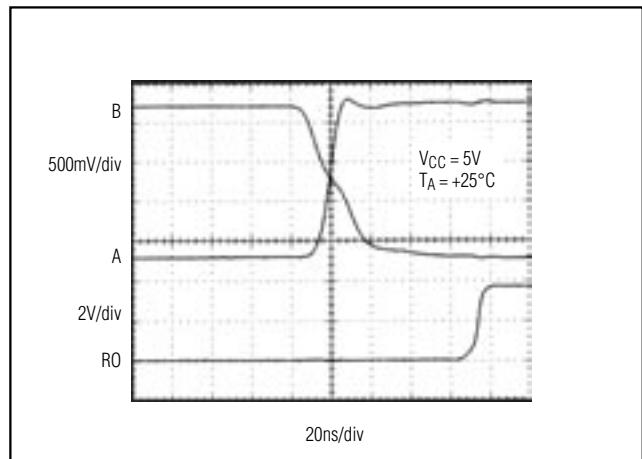

485 Receiver t_{PLH}

XL485-SS MSOP8
 XL485CS SOP8
 XD485 DIP-8
 RS-485/RS422

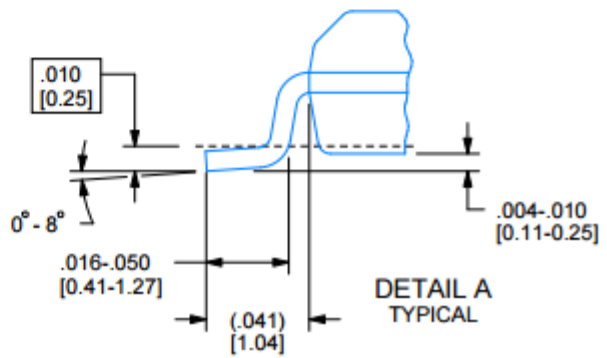
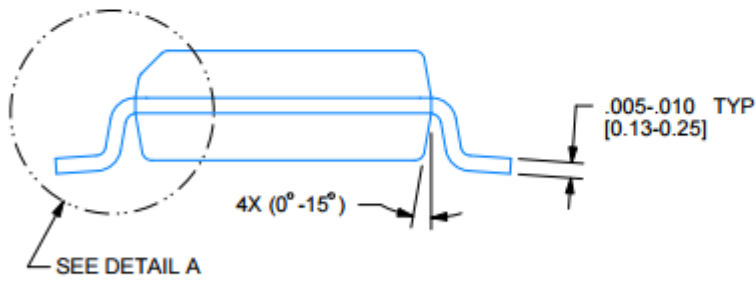
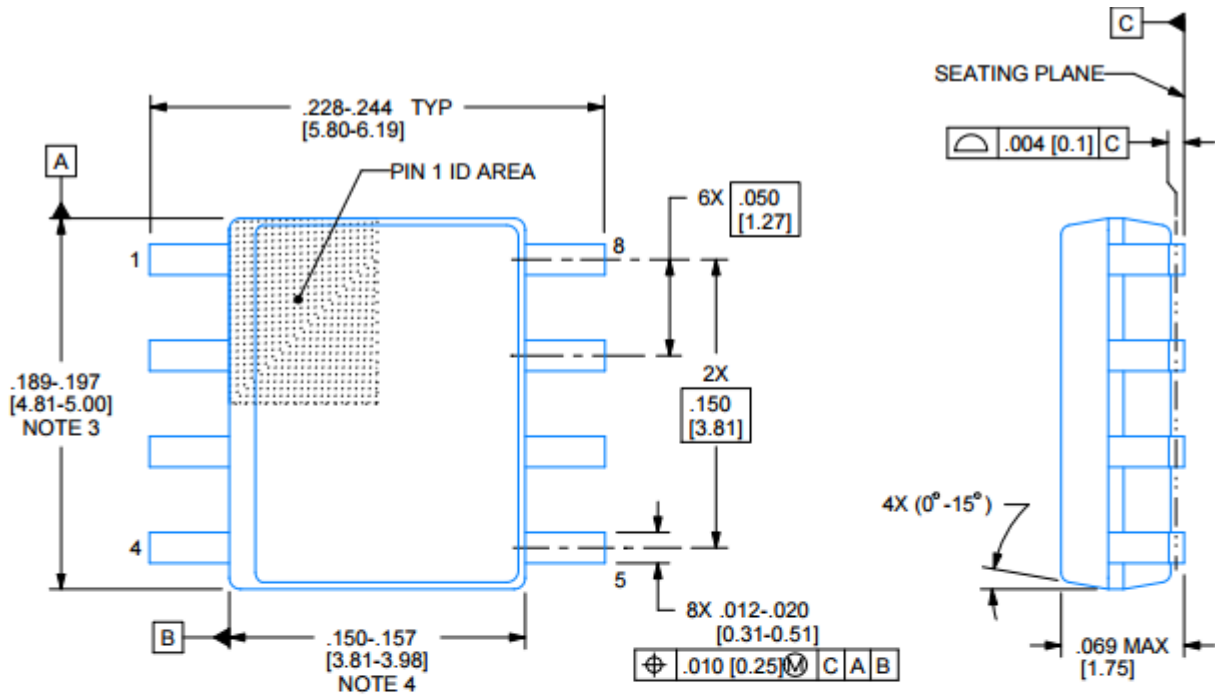

XL485-SS MSOP8
 XL485CS SOP8
 XD485 DIP-8
 RS-485/RS422

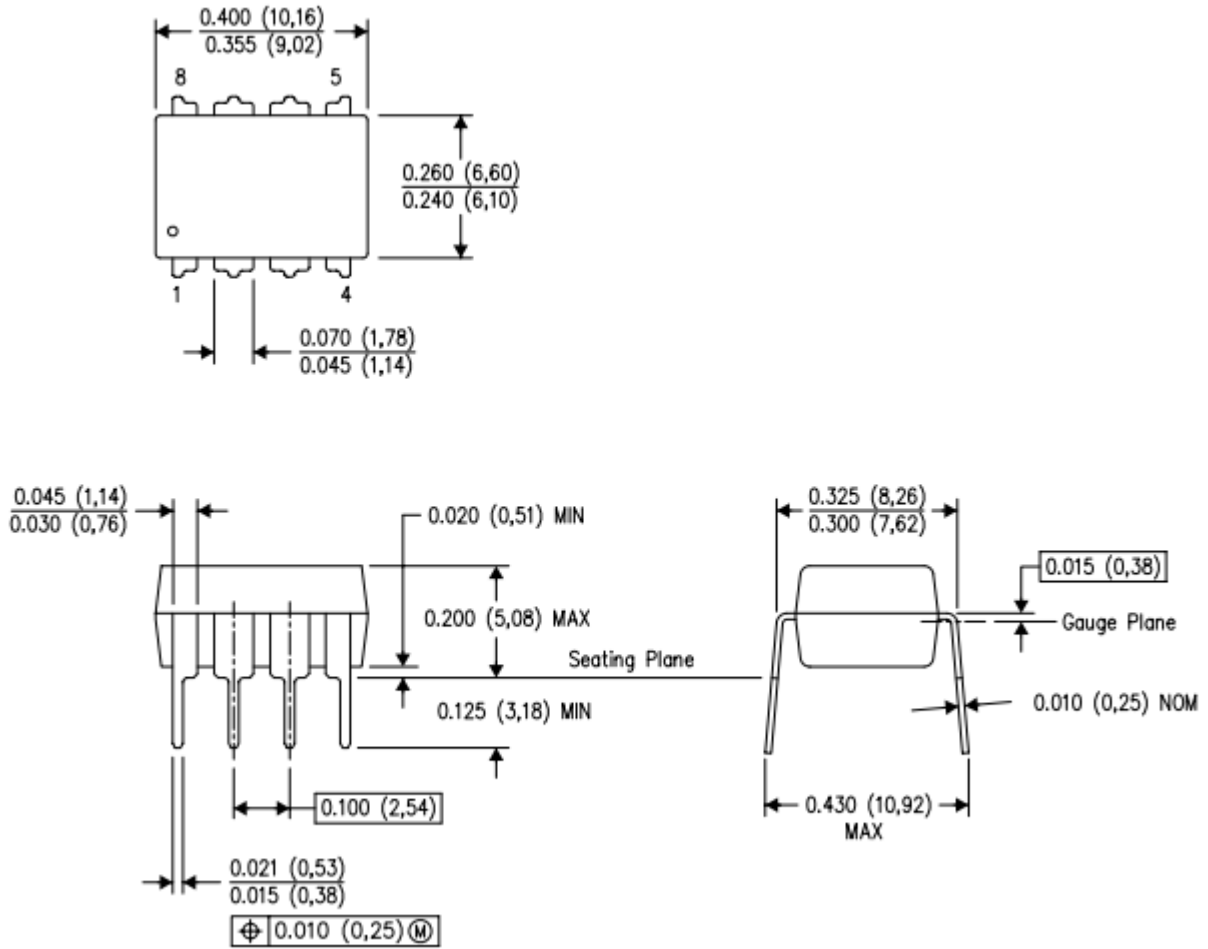

以上信息仅供参考. 如需帮助联系客服人员。谢谢 XINLU DA