

**Getting started with AT32F435ZMT7**

---

## Introduction

AT-START-F435 is designed to help you explore the high performance of the 32-bit microcontroller AT32F435 that embeds ARM Cortex<sup>®</sup>-M4 core with FPU, and expedite application development.

AT-START-F435 is an evaluation board based on AT32F435ZMT7 microcontroller. The device contains such peripherals as LEDs, buttons, two USB micro-B connectors, type-A connector, Arduino<sup>™</sup> Uno R3 extension interfaces and 16 MB SPI Flash memory (extended through QSPI1). This evaluation board embeds AT-Link-EZ for debugging/programming without the need of other development tools.

## Contents

<b>1</b>	<b>Overview .....</b>	<b>5</b>
1.1	Features .....	5
1.2	Definition of terms .....	5
<b>2</b>	<b>Quick start .....</b>	<b>6</b>
2.1	Get started.....	6
2.2	AT-START-F435 development toolchains .....	6
<b>3</b>	<b>Hardware and layout .....</b>	<b>7</b>
3.1	Power supply selection.....	9
3.2	IDD.....	9
3.3	Programming and debugging: embedded AT-Link-EZ .....	9
3.4	Boot mode selection.....	10
3.5	External clock source .....	10
3.5.1	HEXT clock source.....	10
3.5.2	LEXT clock source .....	10
3.6	LEDs .....	11
3.7	Buttons .....	11
3.8	OTGFS configuration.....	11
3.9	QSPI1 interfacing Flash memory.....	11
3.10	0Ω resistors .....	12
3.11	Extension interfaces .....	13
3.11.1	Arduino™ Uno R3 interface .....	13
3.11.2	LQFP144 I/O extension interface.....	14
<b>4</b>	<b>Schematic .....</b>	<b>15</b>
<b>5</b>	<b>Revision history .....</b>	<b>19</b>

## List of tables

Table 1. Boot mode selection jumper settings .....	10
Table 2. 0Ωresistor settings .....	12
Table 3. Arduino™ Uno R3 extension interface pin definition .....	13
Table 4. Document revision history.....	19

## List of figures

Figure 1. Hardware block diagram .....	7
Figure 2. Top layer .....	8
Figure 3. Bottom layer .....	8
Figure 4. Schematic (AT-Link-EZ) .....	15
Figure 5. Schematic (microcontroller).....	16
Figure 6. Schematic (power supply and peripherals).....	17
Figure 7. Schematic (extension interfaces) .....	18

# 1 Overview

## 1.1 Features

AT-START-F435 has the following characteristics:

- AT-START-F435 has an on-board AT32F435ZMT7 microcontroller that embeds ARM Cortex®-M4F 32-bit core with FPU, 4032 KB Flash memory and 384 KB SRAM, in LQFP144 packages.
- On-board AT-Link interface:
  - On-board AT-Link-EZ can be used for programming and debugging (AT-Link-EZ is a simplified version of AT-Link, without offline mode support)
  - If AT-Link-EZ were disassembled from the board by bending it along the joint, this interface can be connected to an independent AT-Link for programming and debugging.
- On-board 20-pin ARM standard JTAG interface (can be connected to JTAG or SWD connector for programming and debugging)
- 16 MB SPI (EN25QH128A) is used as extended Flash memory
- Various power supply methods:
  - USB bus of AT-Link-EZ
  - OTG1 or OTG2 bus ( $V_{BUS1}$  or  $V_{BUS2}$ ) of AT-START-F435
  - External 5 V power supply (E5V)
  - External 3.3 V power supply
- 4 x LED indicators:
  - LED1 (red) indicates 3.3 V power-on
  - 3 x USER LEDs, LED2 (red), LED3 (yellow) and LED4 (green), indicate operation status
- User button and Reset button
- 8 MHz HEXT crystal
- 32.768 kHz LEXT crystal
- On-board USB type-A and micro-B connectors in order to demonstrate OTG1 function
- OTG2 has micro-B connector (If the user wants to use OTG2 master mode, an adapter cable is required)
- Rich extension interfaces are available for quick prototyping
  - Arduino™ Uno R3 extension interface
  - LQFP144 I/O extension interface

## 1.2 Definition of terms

- **Jumper JPx ON**  
Jumper is installed.
- **Jumper JPx OFF**  
Jumped is not installed.
- **Resistor Rx ON / network resistor PRx ON**  
Short by solder, 0Ω resistor or network resistor.
- **Resistor Rx OFF / network resistor PRx OFF**  
Open.

## 2 Quick start

### 2.1 Get started

Configure the AT-START-F435 board in the following sequence:

1. Check the Jumper's position on board:
  - JP1 is connected to GND or OFF (BOOT0 = 0, and BOOT0 has an pull-down resistor in the AT32F435ZMT7);
  - JP2 is connected to GND (BOOT1=0)
  - JP4 is connected to USART1
2. Connect AT\_Link\_EZ to PC via a USB cable (Type A to micro-B), and supply power to the evaluation board via a USB connector CN6. LED1 (red) is always on, and three other LEDs (LED2 to LED4) start to blink in turn.
3. After pressing the user button (B2), the blinking frequency of three LEDs are changed.

### 2.2 AT-START-F435 development toolchains

- ARM® Keil®: MDK-ARM™
- IAR™: EWARM

## 3 Hardware and layout

AT-START-F435 board is designed around an AT32F435ZMT7 microcontroller in LQFP144 package.

*Figure 1* shows the connections between AT-Link-EZ, AT32F435ZMT7 and their peripherals (buttons, LEDs, USB OTG, SPI and extension connectors)

*Figure 2* and *Figure 3* shows their respective locations on the AT-Link-EZ and AT-START-F435 board.

**Figure 1. Hardware block diagram**

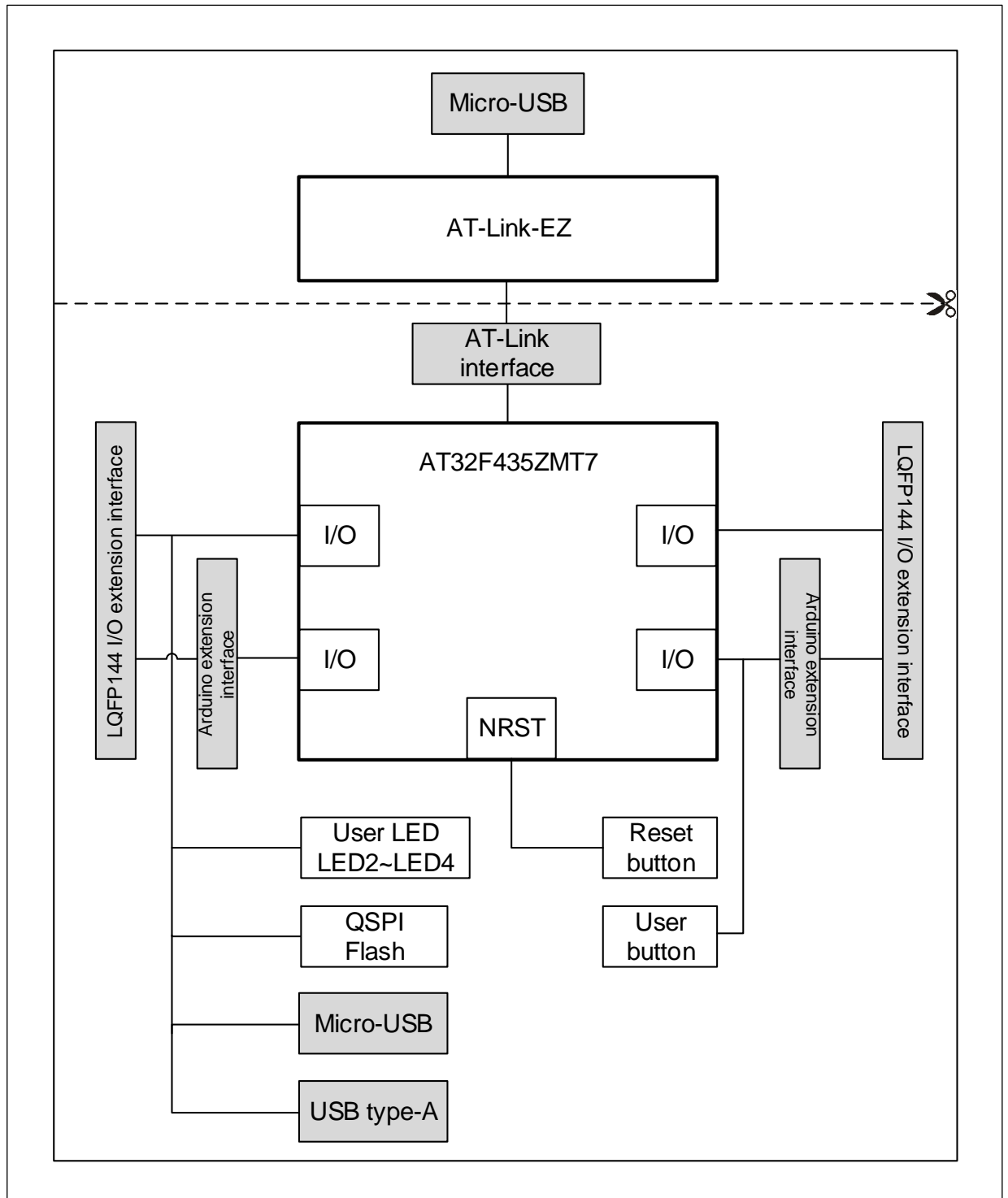

Figure 2. Top layer

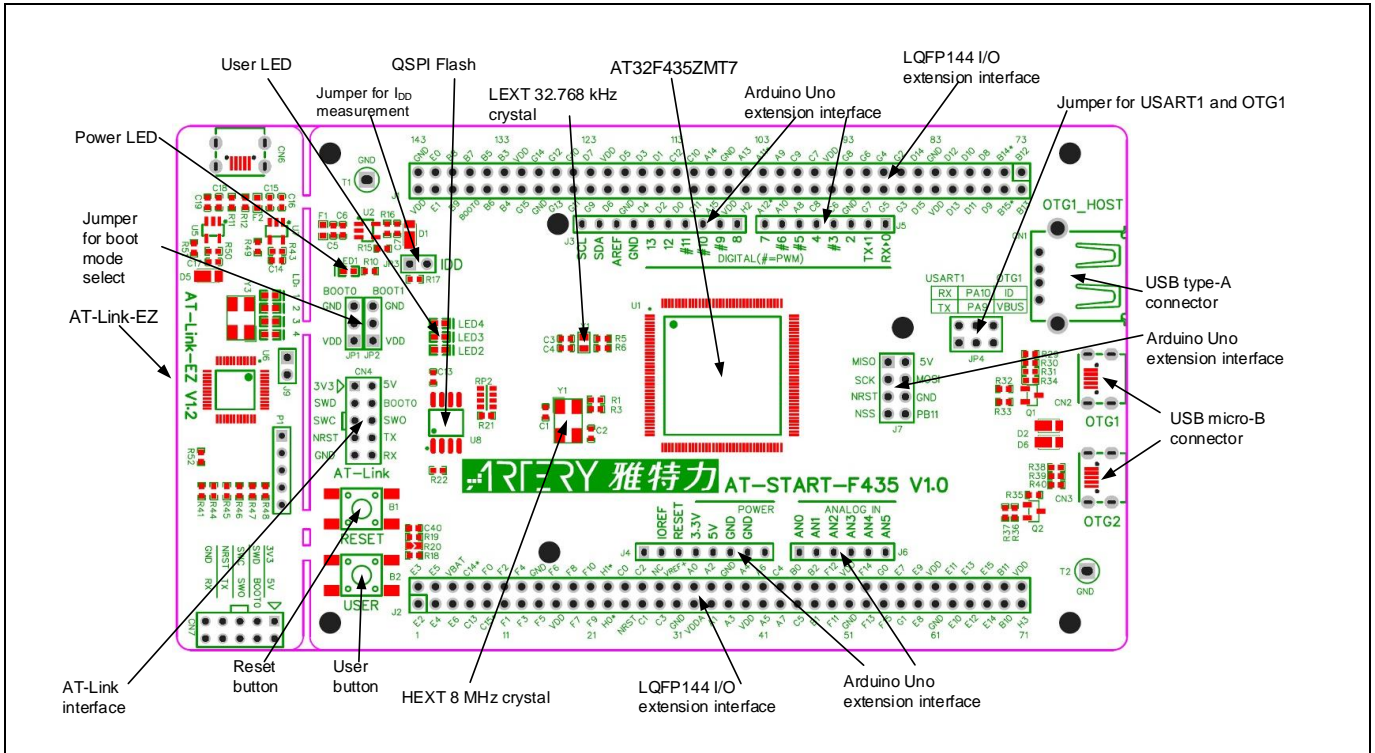
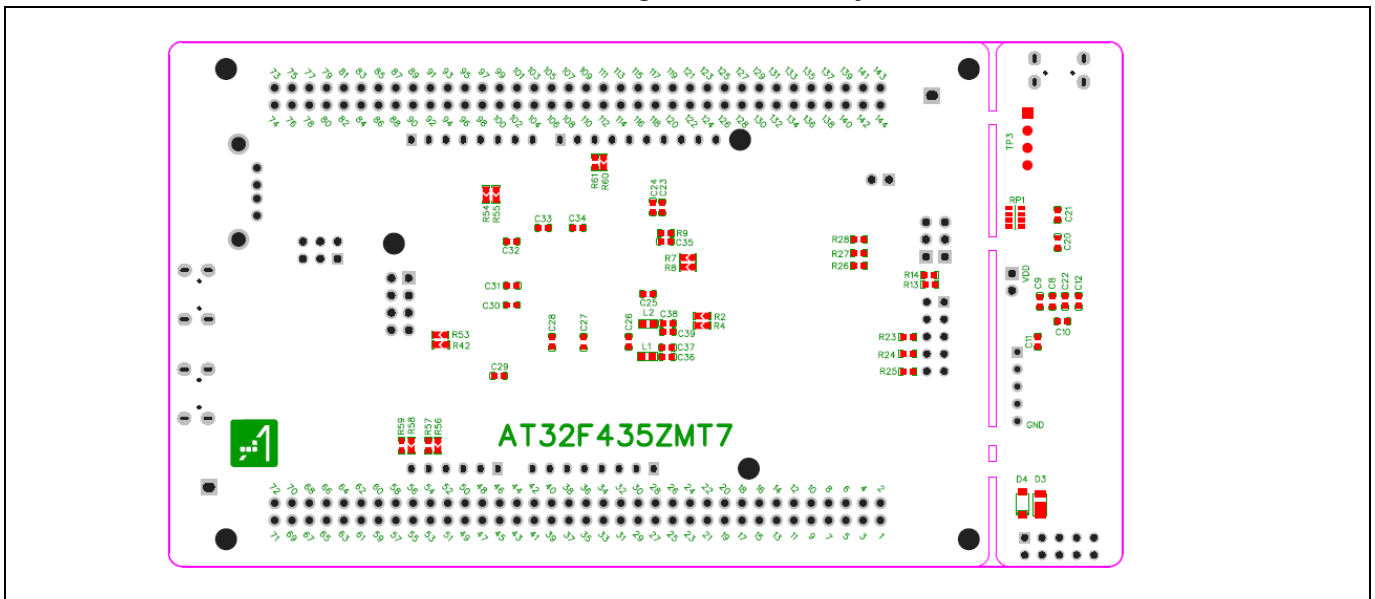

Figure 3. Bottom layer





### 3.1 Power supply selection

The AT-START-F435 can not only be provided with 5 V through a USB cable (either through USB connector CN6 on AT-Link-EZ or USB connector CN2/CN3 on AT-START-F435), but also be provided with an external 5 V power supply (E5V). Then 5 V power provides 3.3 V for the microcontroller and its peripherals using on-board 3.3 V voltage regulator (U2).

5 V pin of J4 or J7 can also be used as an input power, so the AT-START-F435 board can be supplied through a 5 V power unit.

The 3.3 V pin of J4, or the VDD of J1 and J2 can be used as 3.3 V input directly, so AT-START-F435 board can also be supplied by a 3.3 V power unit.

*Note: 5 V power supply must be provided through USB connector (CN6) on AT-Link-EZ. Any other method cannot power the AT-Link-EZ.*

When another board is connected to J4, 5 V and 3.3 V can be used output power, J7's 5V pin as 5 V output power, the VDD pin of J1 and J2 as 3.3 V output power.

### 3.2 IDD

When JP3 OFF (symbol IDD) and R17 OFF, an ammeter can be connected to measure the power consumption of AT32F435ZMT7.

- **JP3 OFF, R17 ON:**

AT32F435ZMT7 is powered. (Default setting and JP3 plug is not mounted before leaving factory)

- **JP3 ON, R17 OFF:**

AT32F435ZMT7 is powered.

- **JP3 OFF, R17 OFF:**

An ammeter must be connected. If there is no ammeter available, the AT32F435ZMT7 cannot be powered.

### 3.3 Programming and debugging: embedded AT-Link-EZ

The evaluation board integrates Artery AT-Link-EZ for users to program/debug the AT32F435ZMT7 on the AT-START-F435 board. AT-Link-EZ supports SWD interface mode, SWO debug, and a set of virtual COM ports (VCP) to connect to the USART1\_TX/USART1\_RX (PA9/PA10) of AT32F435ZMT7.

Please refer to [AT-Link User Manual](#) for complete details on AT-Link-EZ.

The AT-Link-EZ on board can be disassembled or separated from the AT-START-F435. In this case, the AT-START-F435 can still be connected to the CN7 interface (not mounted before leaving factory) of AT-Link-EZ through CN4 interface (not mounted before leaving factory), or to AT-Link, in order to continue to program and debug the AT32F435ZMT7.

## 3.4 Boot mode selection

At startup, three different boot modes are available for selection through pin configuration.

**Table 1. Boot mode selection jumper settings**

Jumper	Pin configuration		Boot mode
	BOOT1	BOOT0	
JP1 to GND or be OFF JP2 optional or be OFF	X	0	Boot from internal Flash memory (factory default setting)
JP1 to VDD JP2 to GND	0	1	Boot from system memory
JP1 to VDD JP2 to VDD	1	1	Boot from internal SRAM

## 3.5 External clock source

### 3.5.1 HEXT clock source

There are three methods to configure the external high-speed clock sources by hardware:

- **On-board crystal (Factory default setting)**  
On-board 8 MHz crystal is used as HSE clock source. The hardware must be configured: R1 and R3 ON, R2 and R4 OFF.
- **External oscillator from PH0**  
External oscillator is injected from the pin\_23 of J2. The hardware must be configured: R2 ON, R1 and R3 OFF. To use PH1 as GPIO, R4 ON can be connected to the pin\_24 of J2.
- **HSE unused**  
PH0 and PH1 are used as GPIOs. The hardware must be configured: R14 and R16 ON, R1 and R15 OFF.

### 3.5.2 LEXT clock source

There are three methods to configure the external low-speed clock sources by hardware:

- **On-board crystal (Factory default setting)**  
On-board 32.768 kHz crystal is used as LEXT clock source. The hardware must be configured: R5 and R6 ON, R7 and R8 OFF
- **External oscillator from PC14**  
External oscillator is injected from the pin\_3 of J2. The hardware must be configured: R7 and R8 ON, R5 and R6 OFF.
- **LEXT unused**  
PC14 and PC15 are used as GPIOs. The hardware must be configured: R7 and R8 ON, R5 and R6 OFF.

### 3.6 LEDs

- **Power LED1**  
Red LED indicates that the AT-START-F435 is powered by 3.3 V.
- **User LED2**  
Red LED is connected to the PD13 pin of AT32F435ZMT7.
- **User LED3**  
Yellow LED is connected to the PD14 pin of AT32F435ZMT7.
- **User LED4**  
Green LED is connected to the PD15 pin of AT32F435ZMT7.

### 3.7 Buttons

- **Reset B1: Reset button**  
It is connected to NRST to reset AT32F435ZMT7 microcontroller.
- **User B2: User button**  
It is connected to the PA0 of AT32F435ZMT7 to act as a wakeup button (R19 ON and R21 OFF), or to the PC13 to acts as TAMPER-RTC button (R19 OFF and R21 ON)

### 3.8 OTGFS configuration

AT-START-F435 board supports OTGFS1 and OTGFS2 full-speed/low-speed host or full-speed device mode via a USB micro-B connector (CN2 or CN3). In device mode, AT32F435ZMT7 can be directly connected to the host through USB micro-B, and  $V_{BUS1}$  or  $V_{BUS2}$  can be used as 5 V input of AT-START-F435 board. In host mode, an external USB OTG cable is needed to connect to the external device. The device is powered via USB micro-B interface, which is done by PH3 and PB10 controlling SI2301 switch.

AT-START-F435 board has a USB type-A extension interface (CN1). This is a OTGFS1 host interface for connecting to U disk and other devices, without the need of USB OTG cable. The USB type-A interface has no power switch control.

When the PA9 or PA10 of the AT32F435ZMT7 is used as OTGFS1\_VBUS or OTGFS1\_ID, the JP4 jumper must select OTG1. In this case, the PA9 or PA10 is connected to USB micro-B CN2 interface, but disconnected from AT-Link interface (CN4).

### 3.9 QSPI1 interfacing Flash memory

On-board SPI (EN25QH128A), connecting to the AT32F435ZMT7 via QSPI1 interface, is used as an extended Flash memory.

The QSPI1 interface is connected to Flash memory with PF6~10 and PG6. If these GPIOs are used for other purposes, it is recommended to turn off RP2, R21 and R22 in advance.

## 3.10 0Ω resistors

**Table 2. 0Ω resistor settings**

Resistors	State <sup>(1)</sup>	Description
R17 (MCU power consumption measurement)	<b>ON</b>	When JP3 OFF, 3.3V is connected to the microcontroller power to supply microcontroller.
	OFF	When JP3 OFF, 3.3V can be connected to an ammeter to measure the power consumption of the microcontroller. (The microcontroller cannot be powered without ammeter)
R9 (V <sub>BAT</sub> )	<b>ON</b>	V <sub>BAT</sub> is connected to VDD
	OFF	V <sub>BAT</sub> is supplied by the pin_6 (VBAT) of J2.
R1, R2, R3, R4 (HEXT)	<b>ON, OFF, ON, OFF</b>	HEXT clock source comes from on-board crystal Y1
	OFF, ON, OFF, OFF	HEXT clock source: external oscillator from PH0, PH1 is unused.
	OFF, ON, OFF, ON	HEXT clock source: external oscillator from PH0, PH1 is used as GPIO; or PH0, PH1 are used as GPIOs.
R5, R6, R7, R8 (LEXT)	<b>ON, ON, OFF, OFF</b>	LEXT clock source comes from on-board crystal X1
	OFF, OFF, ON, ON	LEXT clock source: external oscillator from PC14; or PC14, PC15 are used as GPIOs.
R19, R21 (User button B2)	<b>ON, OFF</b>	User button B2 is connected to PA0.
	OFF, ON	User button B2 is connected to PC13.
R54, R55 (PA11, PA12)	<b>OFF, OFF</b>	As OTGFS1, PA11 and PA12 are not connected to the pin_31 and pin_32 of J1.
	ON, ON	When PA11 and PA12 are not used as OTGFS1, they are connected to the pin_31 and pin_32 of J1.
R42, R53 (PB14, PB15)	<b>OFF, OFF</b>	As OTGFS2, PB14 and PB15 are not connected to the pin_3 and pin_4 of J1.
	ON, ON	When PB14 and PB15 are not used as OTGFS2, they are connected to the pin_3 and pin_4 of J1.
R56, R57, R58, R59 (Arduino™ A4, A5)	<b>OFF, ON, OFF, ON</b>	Arduino™ A4 and A5 are connected to ADC123_IN11 and ADC123_IN10.
	ON, OFF, ON, OFF	Arduino™ A4 and A5 are connected to I2C1_SDA, I2C1_SCL.
R60, R61 (Arduino™ D10)	<b>OFF, ON</b>	Arduino™ D10 is connected to SPI1_CS.
	ON, OFF	Arduino™ D10 is connected to PVM (TMR4_CH1).

(1) Rx factory default state is shown in BOLD.

### 3.11 Extension interfaces

#### 3.11.1 Arduino™ Uno R3 interface

Female plug J3~J6 and male plug J7 support Arduino™ Uno R3 connector. Most of the daughter boards built on Arduino™ Uno R3 are applicable to AT-START-F435 board.

*Note: The I/Os of the AT32F435ZMT7 are 3.3 V-compatible with Arduino™ Uno R3, but not 5 V.*

**Table 3. Arduino™ Uno R3 extension interface pin definition**

Connector	Pin number	Arduino Pin name	AT32F435 Pin name	Description
J4 (power supply)	1	NC	-	-
	2	IOREF	-	3.3 V reference
	3	RESET	NRST	External reset
	4	3.3V	-	3.3 V input/output
	5	5V	-	5 V input/output
	6	GND	-	Ground
	7	GND	-	Ground
	8	-	-	-
J6 (Analog input)	1	A0	PA0	ADC123_IN0
	2	A1	PA1	ADC123_IN1
	3	A2	PA4	ADC12_IN4
	4	A3	PB0	ADC12_IN8
	5	A4	PC1 or PB9 <sup>(1)</sup>	ADC123_IN11 or I2C1_SDA
	6	A5	PC0 or PB8 <sup>(1)</sup>	ADC123_IN10 or I2C1_SCL
J5 (Logic input/output low byte)	1	D0	PA3	USART2_RX
	2	D1	PA2	USART2_TX
	3	D2	PA10	-
	4	D3	PB3	TMR2_CH2
	5	D4	PB5	-
	6	D5	PB4	TMR3_CH1
	7	D6	PB10	TMR2_CH3
	8	D7	PA8 <sup>(2)</sup>	-
J3 (Logic input/output high byte)	1	D8	PA9	-
	2	D9	PC7	TMR3_CH2
	3	D10	PA15 or PB6 <sup>(1)</sup>	SPI1_CS or TMR4_CH1
	4	D11	PA7	TMR3_CH2 / SPI1_MOSI
	5	D12	PA6	SPI1_MISO
	6	D13	PA5	SPI1_SCK
	7	GND	-	Ground
	8	AREF	-	V <sub>REF+</sub> output
	9	SDA	PB9	I2C1_SDA
	10	SCL	PB8	I2C1_SCL
J7 (Others)	1	MISO	PB14	SPI2_MISO
	2	5V	-	5 V input/output
	3	SCK	PB13	SPI2_SCK

Connector	Pin number	Arduino Pin name	AT32F435 Pin name	Description
	4	MOSI	PB15	SPI2_MOSI
	5	RESET	NRST	External reset
	6	GND	-	Ground
	7	NSS	PB12	SPI2_CS
	8	PB11	PB11	-

(1) Refer to [Table 2](#) for details on 0Ω resistors.

### 3.11.2 LQFP144 I/O extension interface

The I/Os of AT-START-F435 microcontroller can be connected to external devices through extension interfaces J1 and J2. All I/Os on the AT32F435ZMT7 are available on these extension interfaces. J1 and J2 can also be measured with oscilloscope, logic analyzer or voltmeter probe.

## 4 Schematic

Figure 4. Schematic (AT-Link-EZ)

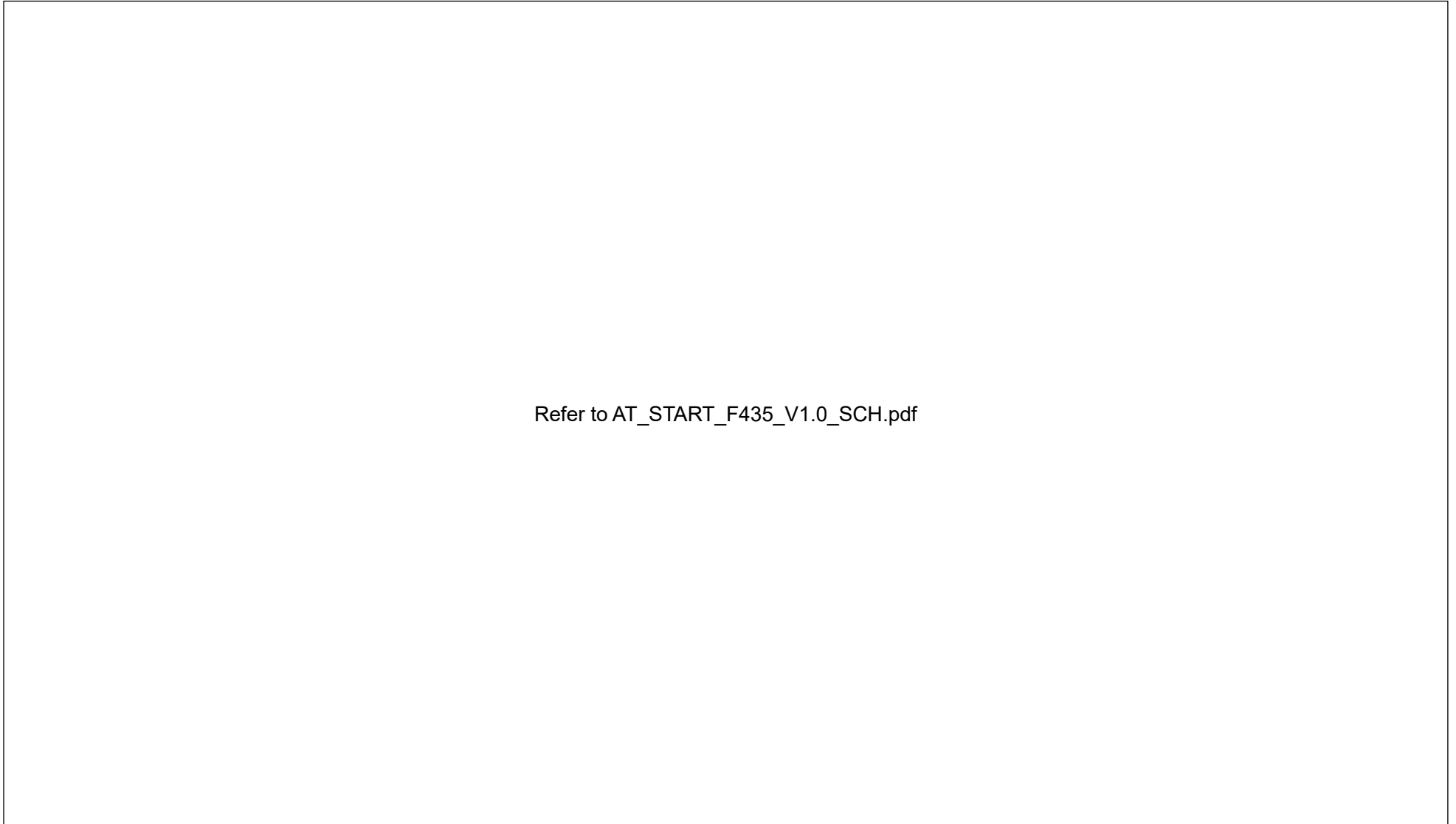

Figure 5. Schematic (microcontroller)

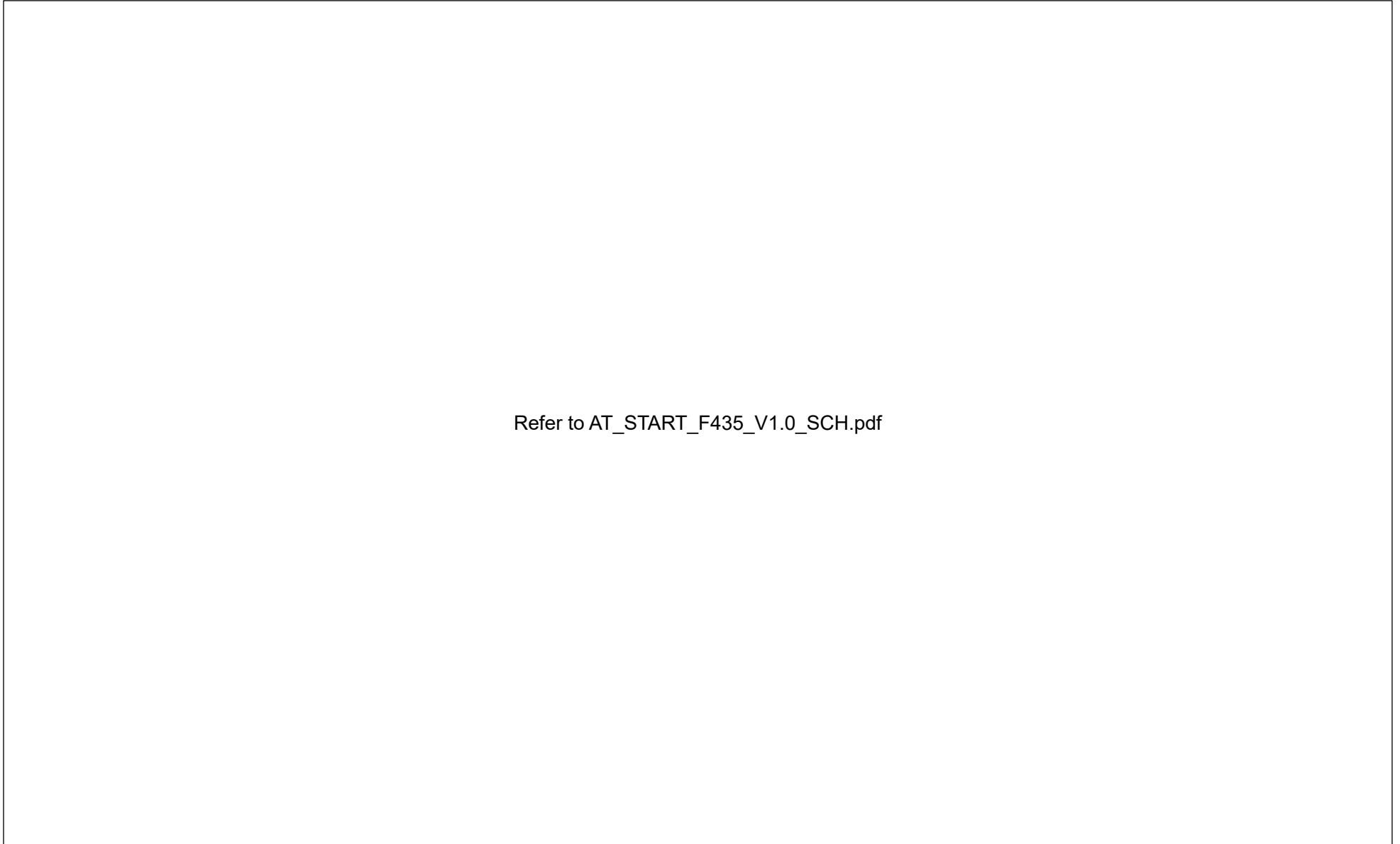



Figure 6. Schematic (power supply and peripherals)

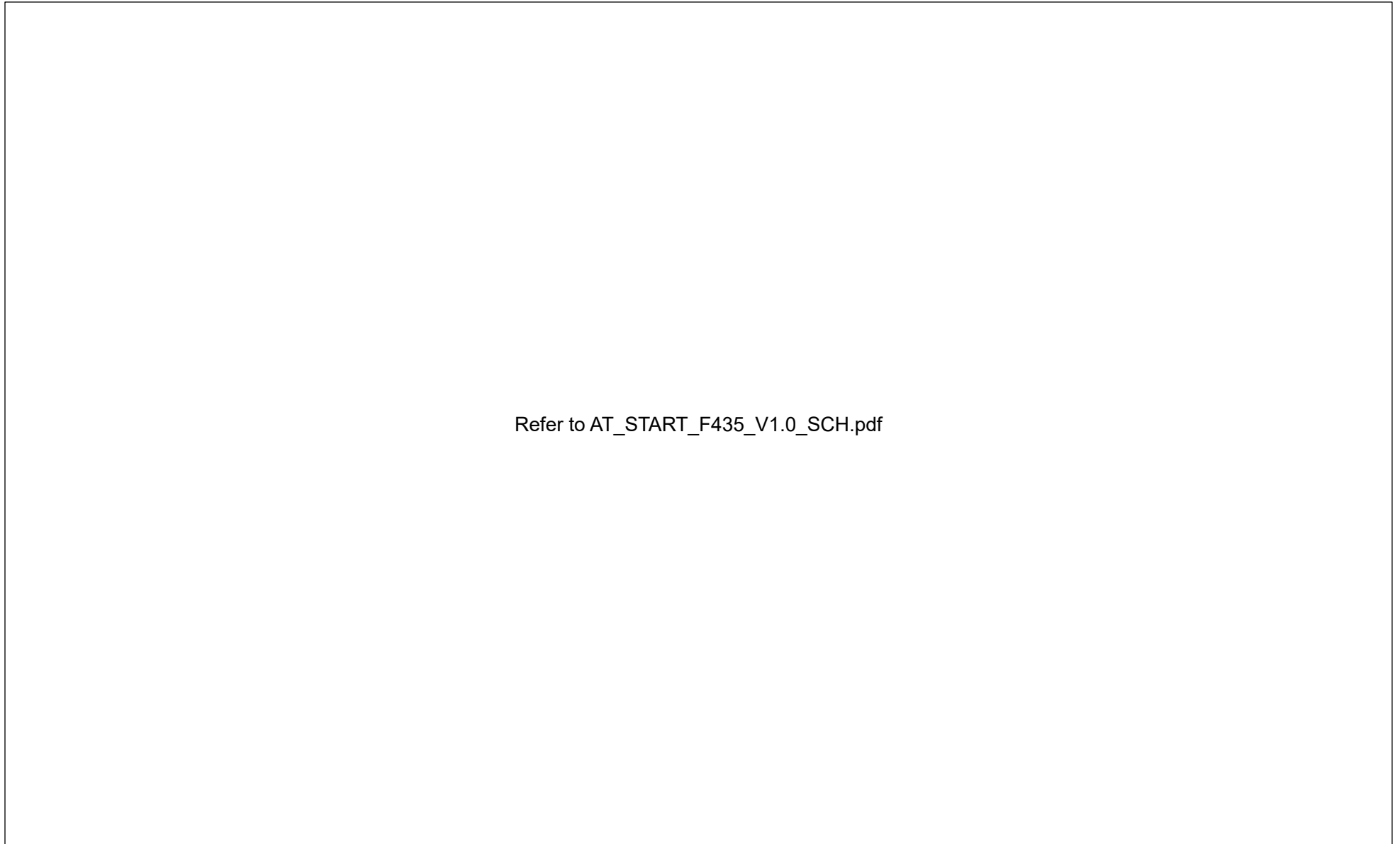
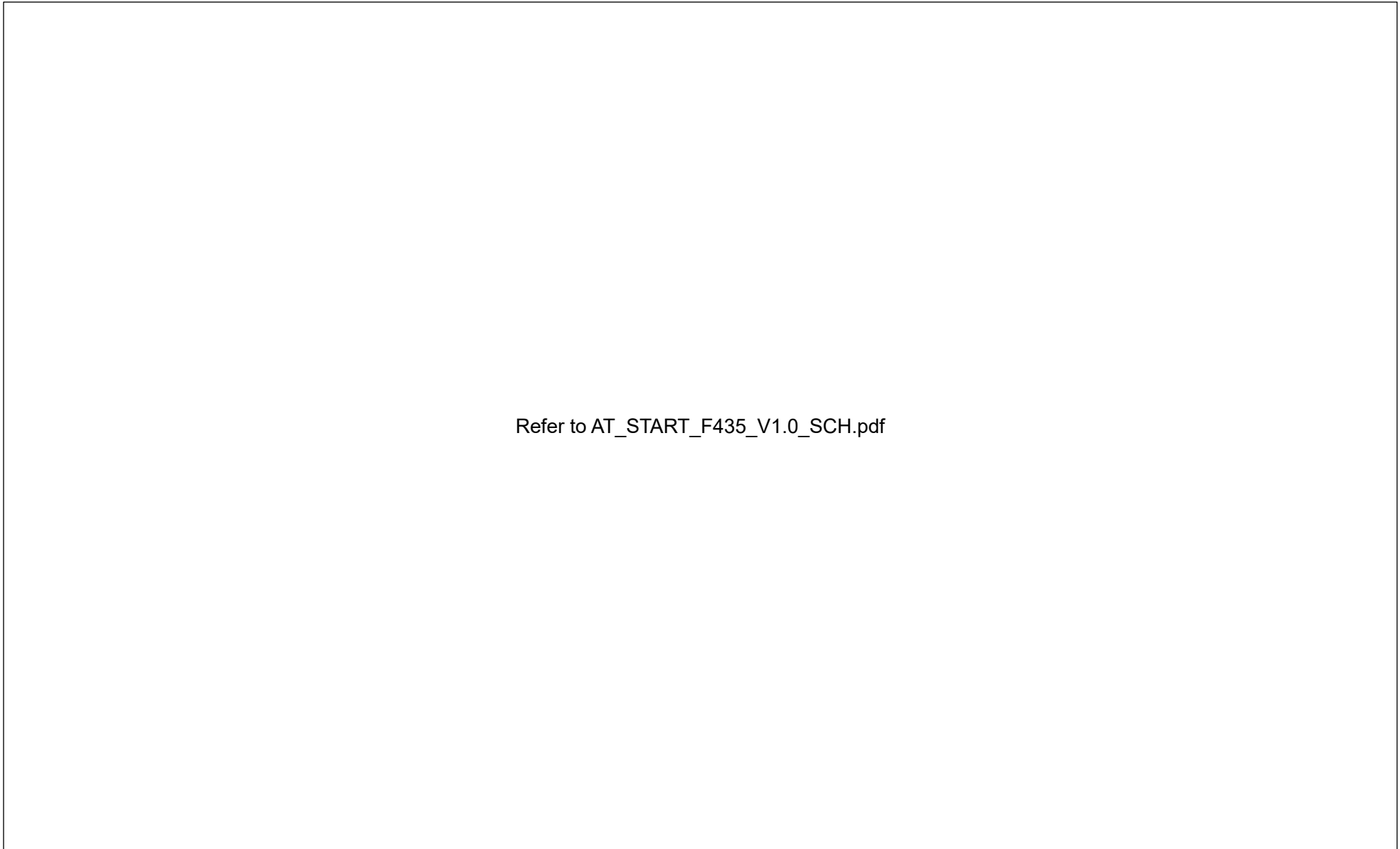

Figure 7. Schematic (extension interfaces)



Refer to AT\_START\_F435\_V1.0\_SCH.pdf

## 5 Revision history

Table 4. Document revision history

Date	Revision	Changes
2021.11.20	1.00	Initial release

## IMPORTANT NOTICE – PLEASE READ CAREFULLY

Purchasers understand and agree that purchasers are solely responsible for the selection and use of Artery's products and services.

Artery's products and services are provided "AS IS" and Artery provides no warranties express, implied or statutory, including, without limitation, any implied warranties of merchantability, satisfactory quality, non-infringement, or fitness for a particular purpose with respect to the Artery's products and services.

Notwithstanding anything to the contrary, purchasers acquires no right, title or interest in any Artery's products and services or any intellectual property rights embodied therein. In no event shall Artery's products and services provided be construed as (a) granting purchasers, expressly or by implication, estoppel or otherwise, a license to use third party's products and services; or (b) licensing the third parties' intellectual property rights; or (c) warranting the third party's products and services and its intellectual property rights.

Purchasers hereby agrees that Artery's products are not authorized for use as, and purchasers shall not integrate, promote, sell or otherwise transfer any Artery's product to any customer or end user for use as critical components in (a) any medical, life saving or life support device or system, or (b) any safety device or system in any automotive application and mechanism (including but not limited to automotive brake or airbag systems), or (c) any nuclear facilities, or (d) any air traffic control device, application or system, or (e) any weapons device, application or system, or (f) any other device, application or system where it is reasonably foreseeable that failure of the Artery's products as used in such device, application or system would lead to death, bodily injury or catastrophic property damage

© 2022 ARTERY Technology – All rights reserved