



DGAR-1083+-D5GS-M12X-WV

Industrial EN50155 802.11 ac/g/n 5G Cellular GPS Router with 3x10/100/1000Base-T(X), M12 Connector

Features

- Leading **EN50155**-compliant wireless access point for rolling stock application
- Provide HNAT enhance LAN to WAN routing performance
- **Provide SNAT/PAT/1:1 NAT**
- Dual high Speed Air Connectivity: each WLAN interface support **IEEE 802.11 ac/g/n** up to 867Mbps link speed
- Highly Security Capability: WEP/WPA/WPA-PSK(TKIP,AES)/WPA2/WPA2-PSK(TKIP,AES)/802.1X Authentication supported
- Support wireless AP/Client mode
- Provide 3x10/100/1000Base-T(X) Ethernet with M12 x-coding
- **Supports 5G and LTE Modem dial up**
- Support GPS connection
- Secured Management by HTTPS
- Various kind of WAN Connection Type supported: Dynamic/Static IP, PPPoE, Modem Dial Up
- IP table configurable to prevent access from unauthorized IP address
- Support VPN for secured network connection (Open VPN , PPTP VPN)
- 1KV isolation for PoE P.D. port
- Support NAT Setting (Virtual Server , Port Trigger)
- Support DHCP forwarding through PPTP function
- Wireless connecting status monitoring
- Wifi multiple SSID supported
- Event Warning by Syslog, Email, SNMP Trap
- Wall mounting enabled

Preliminary





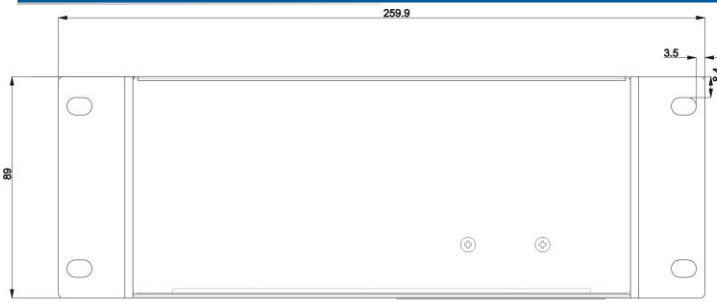

Dimension

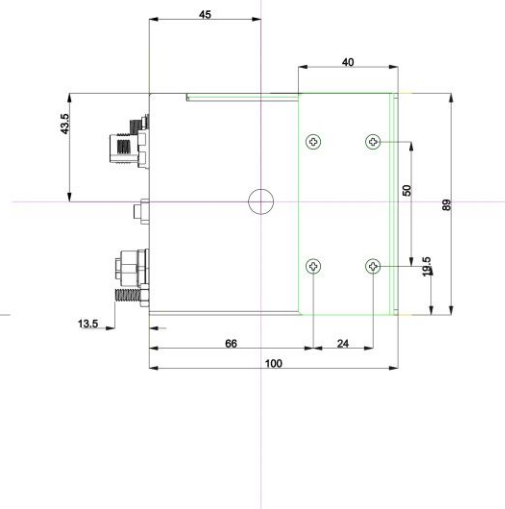
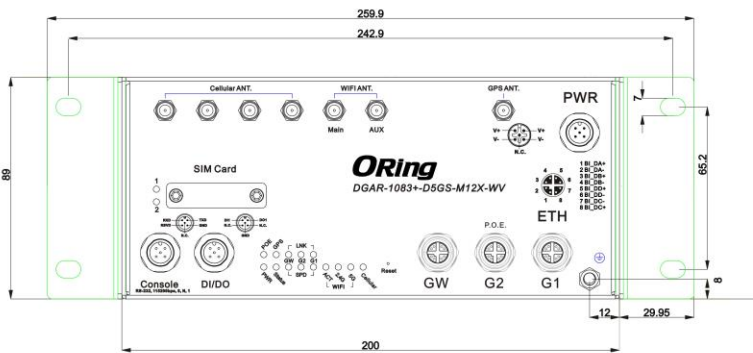
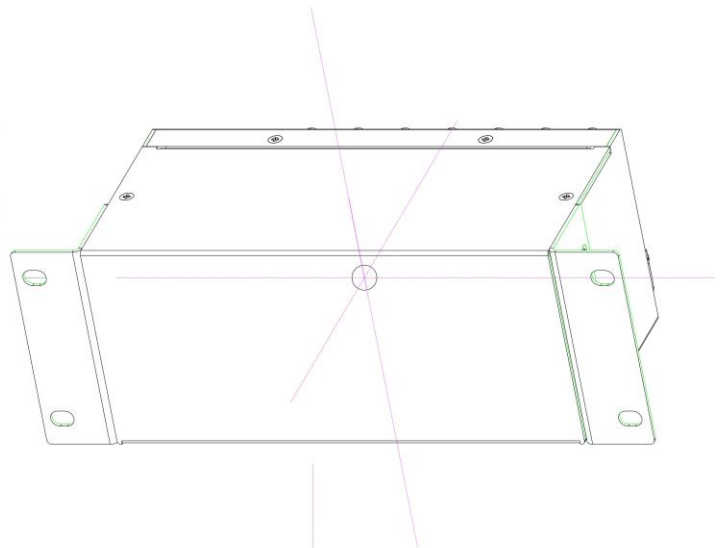
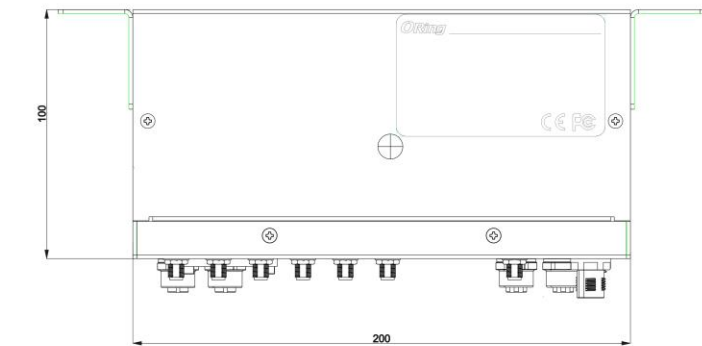

Dimension (Unit =mm)

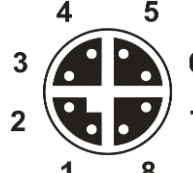
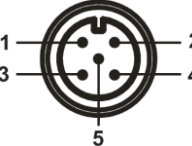
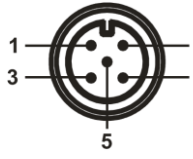

Pin Definition

 <p>A-coding Male</p>	PWR M12 port		 <p>X-coding Female</p>	10/100/1000Base-T(X) M12 port	
	Pin No.	Description		Pin No.	Description
	#1	V+		#1	BI_DA+
	#2	V+		#2	BI_DA-
	#3	V-		#3	BI_DB+
#4	V-	#4	BI_DB-		
#5	N.C.	#5	BI_DD+		
 <p>A-coding Female</p>	Console M12 port		 <p>A-coding Female</p>	DI/DO M12 port	
	Pin No.	Description		Pin No.	Description
	#1	RXD		#1	Digital Input
	#2	TXD		#2	Digital Output
	#3	RSVD		#3	N.C.
#4	GND	#4	N.C.		
#5	N.C.	#5	GND		

Specifications

ORing EN50155 LTE Router Model	DGAR-1083+-D5GS-M12X-WV
Physical Ports	
10/100/1000Base-T(X) Ports in M12 (8-pin X-coding female)	1(WAN) + 2(LAN)
Sim Card Slot	2
Console Port in M12 (5-pin A-coding female)	1
DI/DO Port in M12 (5-pin A-coding female)	DI x 1, DO x 1 (DI :Logic level 1: 5V~30V, Logic level 0: 0V~2V DO :Maximum Voltage is 30V, Maximum Current is 20mA)
Input Power Port in M12 (5-pin A-coding male)	1
PoE P.D Port	Present at Ethernet (G2) Fully compliant with IEEE 802.3at Power Device specification Over load & short circuit protection Isolation Voltage: 1000 VDC min. Isolation Resistance : 10 ⁸ ohms min
Antenna connector	
WIFI	2 x SMA female
Cellular	4 x SMA female
GPS	1 x SMA female
GPS Interface	
Receiver Type	50 Channels GPS L1 frequency, C/A Code
Time-To-First-Fix	Cold Start: 29s Warm Start: 29s Hot Start: <1s
Sensitivity	Tracking & Navigation: -160dBm Reacquisition: -160dBm Cold Start: -147dBm
Cellular Interface	
Cellular Standard	HSDPA / HSUPA / LTE/ LTE+/ 5G
Band Option	5G NR : n1,n2,n3,n5,n7,n8,n12,n20,n28,n41,n66,n71,n77,n78,n79 LTE : FDD : B1/B2/B3/B4/B5/B7/B8/B12/B13/B14/B17/B18/B19/B20/B25/B26/B28/B29/B30/B32/B66/B71 TDD : B34/B38/B39/B40/B41/B42/B46/B48 WCDMA : B1/B2/B3/B4/B5/B6/B8/B9/B19
WLAN interface	
Modulation	IEEE 802.11a: OFDM IEEE 802.11b: CCK, DQPSK, DBPSK IEEE 802.11g: OFDM IEEE 802.11n: BPSK, QPSK, 16-QAM, 64-QAM IEEE 802.11ac: BPSK, QPSK, 16-QAM, 64-QAM, 256-QAM
Frequency Band	America / FCC: 2.412~2.462 GHz 5.180~5.240 GHz & 5.745~5.825 GHz Europe CE / ETSI: 2.412~2.472 GHz 5.180~5.240 GHz
Transmission Rate	IEEE 802.11b: 1/2/5.5/11 Mbps IEEE 802.11a/g: 6/9/12/18/24/36/48/54 Mbps IEEE 802.11n: UP to 300 Mbps IEEE 802.11ac: up to 867Mbps
Transmit Power	IEEE 802.11a: 15dBm ± 2dBm@54Mbps

	IEEE 802.11b: 18dBm ± 2dBm@11Mbps IEEE 802.11g: 15dBm ± 2dBm@54Mbps IEEE 802.11gn HT20: 13dBm ± 2dBm @MCS7 IEEE 802.11gn HT40: 13dBm ± 2dBm @MCS7 IEEE 802.11an HT20: 13dBm ± 2dBm @MCS7 IEEE 802.11an HT40: 12dBm ± 2dBm @MCS7 IEEE 802.11ac VHT80: 10dBm ± 2dBm @MCS9
Receiver Sensitivity	IEEE 802.11a : -65dBm ± 2dBm@54Mbps IEEE 802.11b : -76dBm ± 2dBm@11Mbps IEEE 802.11g : -65dBm ± 2dBm@54Mbps IEEE 802.11gn HT20:-64dBm ± 2dBm@MCS7 IEEE 802.11gn HT40:-61dBm ± 2dBm@MCS7 IEEE 802.11an HT20:-64dBm ± 2dBm@MCS7 IEEE 802.11an HT40:-61dBm ± 2dBm@MCS7 IEEE 802.11ac VHT80:-51dBm ± 2dBm@MCS9
Encryption Security	WEP: (64-bit ,128-bit key supported) WPA/WPA2 :802.11i(WEP and AES encryption) WPA-PSK (256-bit key pre-shared key supported) 802.1X Authentication supported TKIP encryption
Wireless Security	SSID broadcast disable
Protocol Support	
Protocol	ARP,BOOTP, DHCP, DNS, HTTP, IP, ICMP, SNTP, TCP, UDP, RADIUS, SNMP, PPPoE, STP (IEEE 802.1D)
LED Indicators	
PWR	1 x LED, Green for DC Power in
POE	1 x LED, Green for POE Power in
Ethernet Port Indicator	6 x LEDs, LNK: Green for port Link/Act. SPD: Green On for 1000/100Base-T(X) link; Green Off for 10Base link
GPS LED	1 x LED, Green on for GPS on, slow blink for connection Act
WLAN(Wifi) LED	3 x LEDs, 1 x LED, Green On: RF on, Blink: data transmitting 1 x LED, Green for WLAN work on 2.4GHz 1 x LED, Green for WLAN work on 5GHz
Cellular LED	1 x LED, Green slow blink for work normal,
Status Indicator	1 x LED, Green slow blink for normal, off for system halt
Power	
Input Power	24 ~ 110Vdc
Isolation	TBD
Power Consumption (Typ.)	TBD
Overload Current Protection	Present
Reverse Polarity Protection	Present
Physical Characteristic	
Enclosure	IP-30
Dimension (W x D x H)	200(W) x 100(D) x 89(H) mm
Weight (g)	<2Kg
Environmental	
Storage Temperature	-40 to 85°C (-40 to 185°F)
Operating Temperature	-25 to 70°C (-13 to 158°F)
Operating Humidity	5% to 95% Non-condensing
Regulatory Approvals	
EMI	FCC Part 15, CISPR (EN55022) class A, EN50155 (EN50121-3-2, EN55011, EN50121-4)
EMS	EN61000-4-2 (ESD), EN61000-4-3 (RS), EN61000-4-4 (EFT), EN61000-4-5 (Surge), EN61000-4-6 (CS), EN61000-4-8, EN61000-4-11
Shock	IEC60068-2-27, EN61373
Free Fall	IEC60068-2-31
Vibration	IEC60068-2-6, EN61373

Rail Traffic	EN50155
Cooling	EN60068-2-1
Dry Heat	EN60068-2-2
Safety	EN60950-1
Warranty	5 years

