

TO-220 & TO-218 & TO-247 Heat Sinks

SW25, SW38, SW50, SW63

Extruded heat sink with unequal channel widths



Extruded heat sink with unequal channel widths front and back

can accommodate a TO-220, TO-218, or TO-247 devices. Includes two solderable mounting pins which permit vertical mounting and eliminate stress on device leads. Available in three heights. Version without hole uses clip 5901 (sold separately) to attach device. See page 97 for clip information.

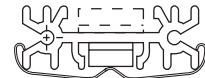
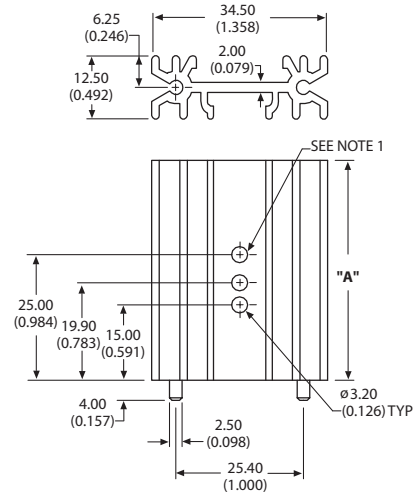
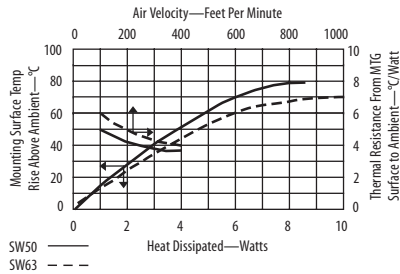
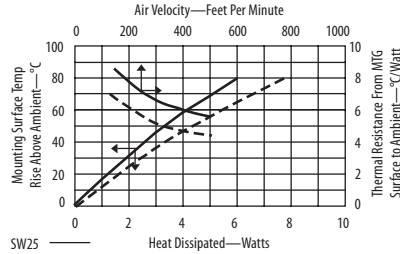

NOTE 1: This hole not present in SW25 model

Material: Aluminum
Finish: Black Anodize

ORDERING INFORMATION

Part Number	Description	"A" Dim	Holes	Dia of PCB Plated Thru Hole for Pins
SW25-2G	Extruded heat sink with unequal channel widths front and back	25.00 (0.984)	No	3.00 (0.118)
SW25-4G	With device mounting holes	25.00 (0.984)	Yes	3.00 (0.118)
SW38-2G	Extruded heat sink with unequal channel widths front and back	38.00 (1.496)	No	3.00 (0.118)
SW38-4G	With device mounting holes	38.00 (1.496)	Yes	3.00 (0.118)
SW50-2G	Extruded heat sink with unequal channel widths front and back	50.00 (1.968)	No	3.00 (0.118)
SW50-4G	With device mounting holes	50.00 (1.968)	Yes	3.00 (0.118)
SW63-2G	Extruded heat sink with unequal channel widths front and back	63.00 (2.480)	No	3.00 (0.118)
SW63-4G	With device mounting holes	63.00 (2.480)	Yes	3.00 (0.118)

5297, 5298, 5299, 5300

Extruded heat sink with large radial fins



Extruded heat sink with large radial fins

features equal channel widths on both sides for single or dual device mounting. Includes two solderable mounting pins which permit vertical mounting and eliminate stress on device leads. Available in four heights for TO-220, TO-218, and TO-247 devices.

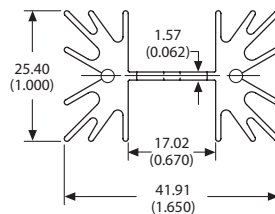
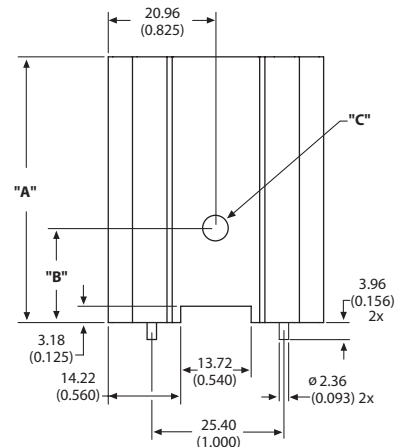
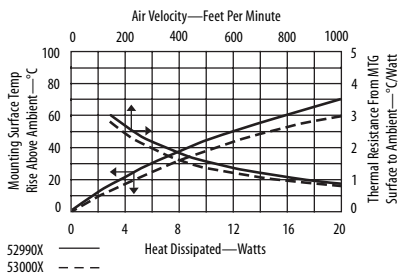
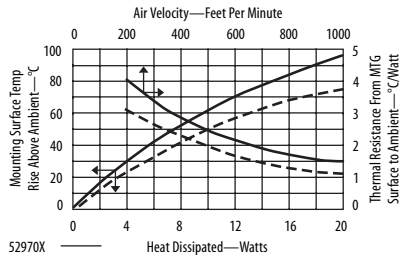

Material: Aluminum
Finish: Black Anodize

ORDERING INFORMATION

Part Number	Device	"A" Dim	"B" Dim	"C" Dim	Dia of PCB Plated Thru Hole for Pins
529701B02500G	TO-218, TO-247	25.40 (1.000)	21.59 (0.850)	3.66 (0.144)	2.67 (0.105)
529702B02500G	TO-220	25.40 (1.000)	18.29 (0.720)	3.17 (0.125)	2.67 (0.105)
529801B02500G	TO-218, TO-247	38.10 (1.500)	21.59 (0.850)	3.66 (0.144)	2.67 (0.105)
529802B02500G	TO-220	38.10 (1.500)	18.29 (0.720)	3.17 (0.125)	2.67 (0.105)
529901B02500G	TO-218, TO-247	50.80 (2.000)	21.59 (0.850)	3.66 (0.144)	2.67 (0.105)
529902B02500G	TO-220	50.80 (2.000)	18.29 (0.720)	3.17 (0.125)	2.67 (0.105)
530001B02500G	TO-218, TO-247	63.50 (2.500)	21.59 (0.850)	3.66 (0.144)	2.67 (0.105)
530002B02500G	TO-220	63.50 (2.500)	18.29 (0.720)	3.17 (0.125)	2.67 (0.105)

For additional options see page 83