

IRIS-M

~25° medium beam optimized for CREE XM-L.
Assembly with holder, sublens and installation
tape.

TECHNICAL SPECIFICATIONS:

Dimensions	Ø 38.0 mm
Height	29.2 mm
Fastening	tape, pin
ROHS compliant	yes ⓘ

MATERIAL SPECIFICATIONS:

Component	Type	Material	Colour	Finish
IRIS	Single lens	PMMA	clear	
IRIS-XM-HLD	Holder	PC	black	
SPUTNIK-TAPE	Tape	Acrylic foam	black	
LEDILSTAR-SUB	Sublens	PC		

ORDERING INFORMATION:

Component	Type	Qty in box	MOQ	MPQ	Box weight (kg)
FCA12777_IRIS-M	Single lens	378	126	42	9.0
» Box size: 480 x 280 x 300 mm					



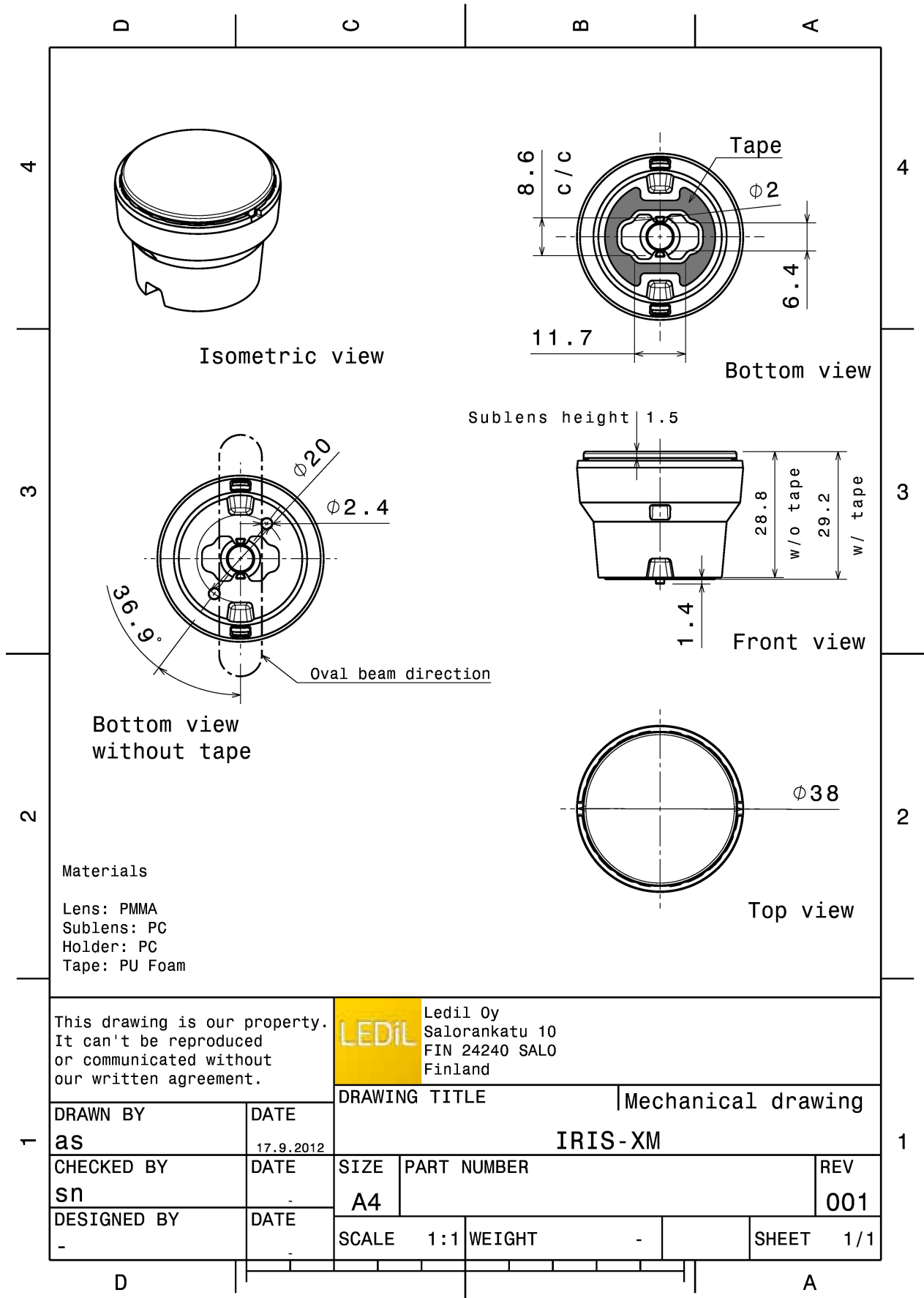

This drawing is our property. It can't be reproduced or communicated without our written agreement.

LEDiL Ledil Oy
Salorankatu 10
FIN 24240 SALO
Finland

DRAWN BY
as

DATE
17.9.2012

DRAWING TITLE | Mechanical drawing

CHECKED BY
sn

DATE
-

SIZE | PART NUMBER | REV

A4 | | **001**

DESIGNED BY
-

DATE
-

SCALE | WEIGHT | SHEET

1:1 | - | **1/1**

See also our general installation guide: www.ledil.com/installation_guide

PHOTOMETRIC DATA (MEASURED):

CREE → LED

LED XHP35 HD
 FWHM / FWTM 29.0° / 50.0°
 Efficiency 83 %
 Peak intensity 2.9 cd/m
 LEDs/each optic 1
 Light colour White
 Required components:

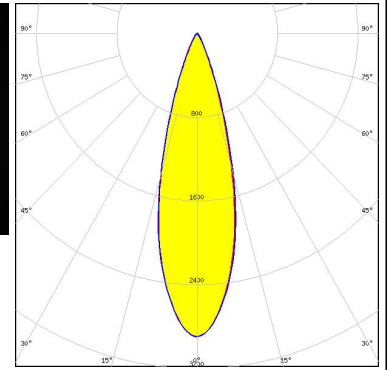
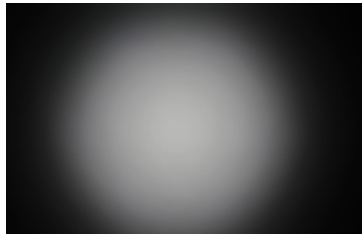

CREE → LED

LED XHP35 HI
 FWHM / FWTM 29.0° / 47.0°
 Efficiency 85 %
 Peak intensity 3.2 cd/m
 LEDs/each optic 1
 Light colour White
 Required components:

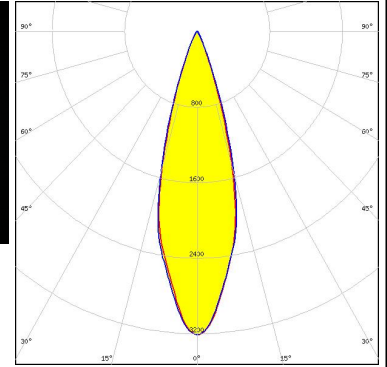

CREE → LED

LED XHP50
 FWHM / FWTM 29.0° / 53.0°
 Efficiency 83 %
 Peak intensity 2.7 cd/m
 LEDs/each optic 1
 Light colour White
 Required components:

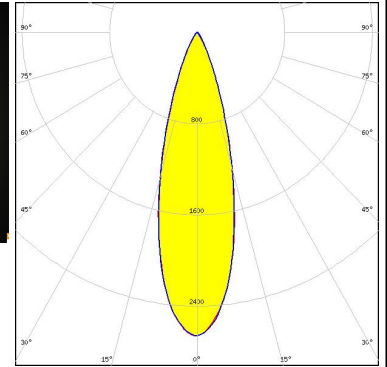
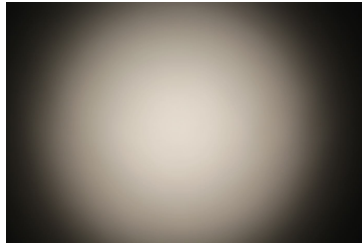

CREE → LED

LED XHP50.2
 FWHM / FWTM 30.0° / 55.0°
 Efficiency 80 %
 Peak intensity 2.4 cd/m
 LEDs/each optic 1
 Light colour White
 Required components:

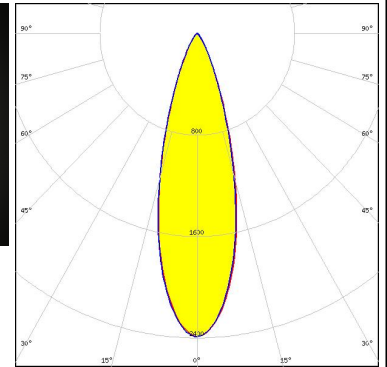
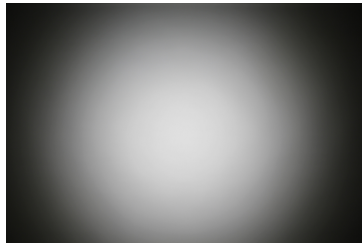

PHOTOMETRIC DATA (MEASURED):



LED XM-L
 FWHM / FWTM 28.0° / 50.0°
 Efficiency 84 %
 Peak intensity 1.4 cd/lm
 LEDs/each optic 1
 Light colour White
 Required components:



LED XM-L2
 FWHM / FWTM 29.0° / 52.0°
 Efficiency 80 %
 Peak intensity 2.9 cd/lm
 LEDs/each optic 1
 Light colour White
 Required components:

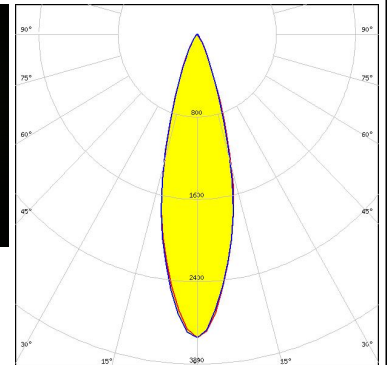

LED NFMW48xA
 FWHM / FWTM 31.0° / 59.0°
 Efficiency 80 %
 Peak intensity 2.2 cd/lm
 LEDs/each optic 1
 Light colour White
 Required components:

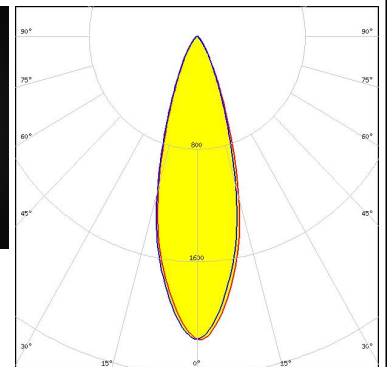
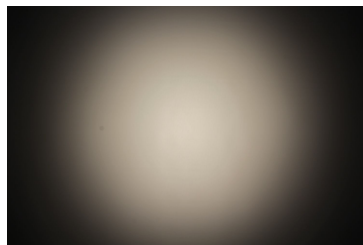

GENERAL INFORMATION:

NOTE: The typical beam angle will be changed by different color, chip size and chip position tolerance. The typical total beam angle is the full angle measured where the luminous intensity is half of the peak value.

MATERIALS:

As part of our continuous research and improvement processes, and to ensure the best possible quality and availability of our products, LEDiL reserves the right to change material grades without notice.

PRODUCT DATA USER AGREEMENT AND DISCLAIMER:

The measured data in the provided downloadable LEDiL Product Datasheets and Mechanical 2D-Drawings is rounded and provided as reference for planning. LEDiL Oy's optical specifications have been verified by conducting performance testing of the products in accordance with the company's quality system. The reported data are averaged results of multiple measurements with typical variation. LEDiL Oy reserves the right to without prior notification make changes and improvements to its products.

LEDiL Oy assumes neither warranty, nor guarantee nor any other liability of any kind for the contents and correctness of the provided data. The provided data has been generated with highest diligence but the provided data may in reality not represent the complete possible variation range of all intrinsic parameters. Therefore, in certain cases a deviation from the provided data could occur.

LEDiL Oy reserves the right to undertake technical changes of its products without further notification which could lead to changes in the provided data. LEDiL Oy assumes no liability of any kind for the possible deviation from any provided data or any other damage resulting from the usage of the provided data.

The user agrees to this disclaimer and user agreement with the download or usage of the provided files.

LEDiL Oy

Joensuunkatu 13
FI-24240 SALO
Finland

LEDiL Inc.

228 West Page Street
Suite D
Sycamore IL 60178
USA

Ledil Optics Technology (Shenzhen) Co., Ltd.

405 , Block B
Casic Motor Building
Shenzhen 518057
P.R.CHINA

Local sales and technical support

[www.ledil.com/
where_to_buy](http://www.ledil.com/where_to_buy)

Shipping locations

Salo, Finland
Hong Kong, China

Distribution Partners

[www.ledil.com/
where_to_buy](http://www.ledil.com/where_to_buy)