

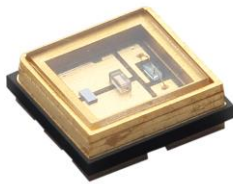

**Part No.: U3535C1VGB10**

**Product picture**



**Product introduction**

This series of deep uv packaging products are specially designed for applications with high radiation power and directivity requirements. The surface of the packaging body in the form of a patch device, and the use of special uv glass, so as to optimize the product life and performance. It can be used in plant lighting, fluorescence analyzer, medical testing, food and pharmaceutical processing, sterilization and other fields.

**Features**

- ✧ Ceramic packaging
- ✧ Standard SMD process
- ✧ In line with the ROHS standard

**Contents**

Outline dimensions .....	3
Photoelectric properties .....	4
Limit service condition(UVC).....	4
Photoelectric parameter curve(UVC) .....	5
Packaging.....	7
Reliability test.....	9
Recommended reflow temperature curve formula .....	9



Part No.: U3535C1VGB10

Outline dimensions: (Unit: mm, The tolerance  $\pm 0.1\text{mm}$ )

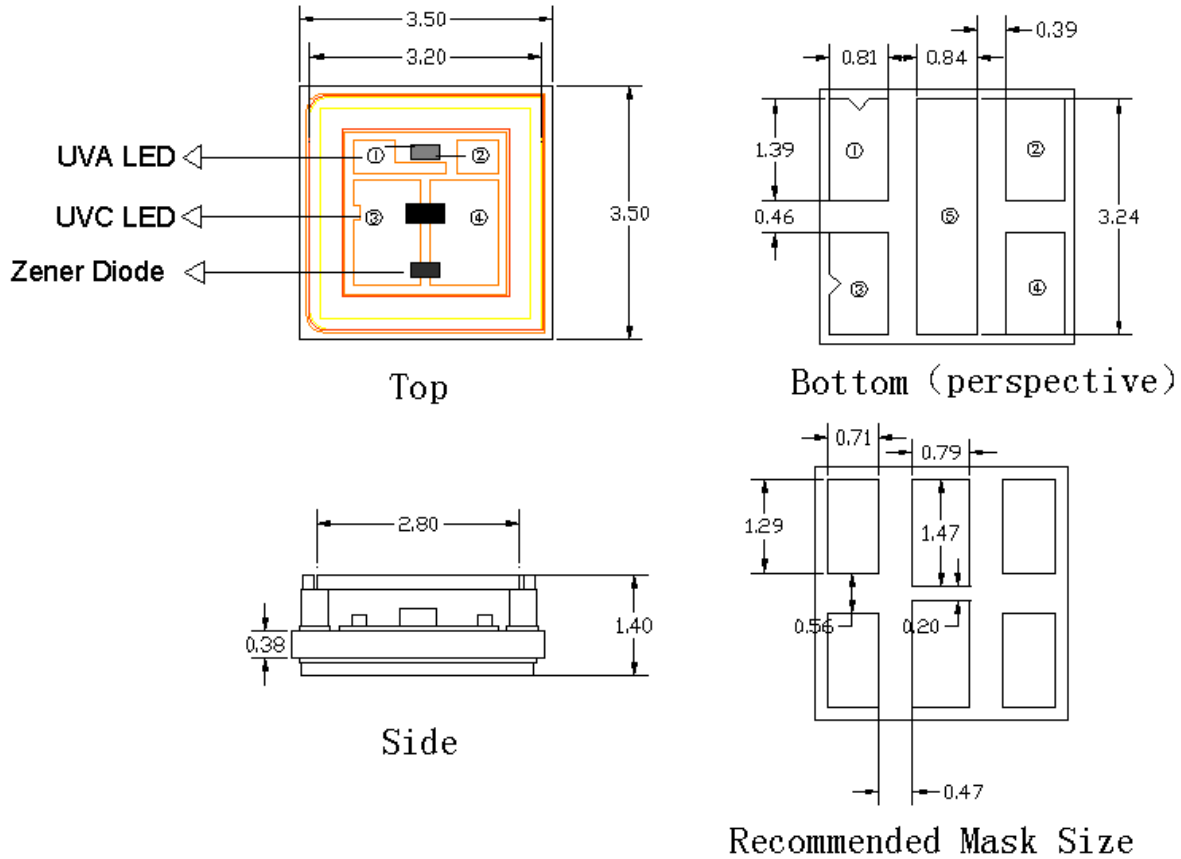

①: UVA- ②: UVA+ ③: UVC- ④: UVC+ ⑤: Cooling pad

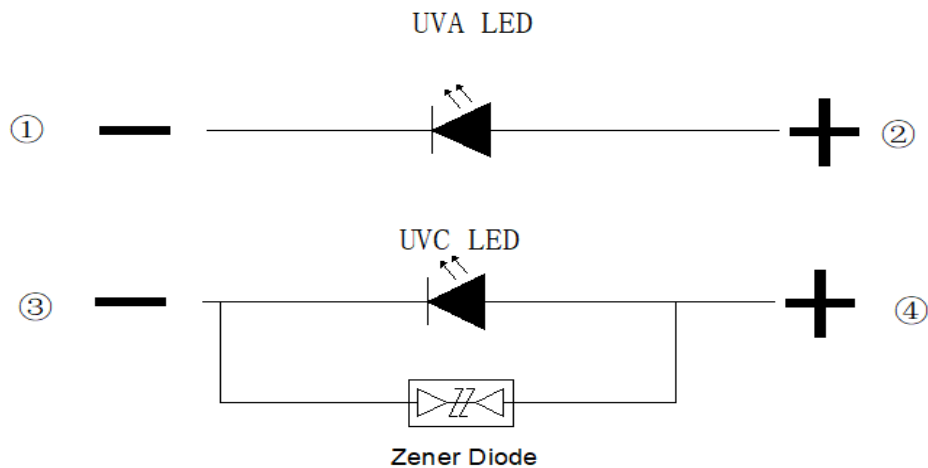



Part No.: U3535C1VGB10

Photoelectric properties (Ta = 25°C)

Parameter	Symbol	Forward current	Symbol	Min.	Typ	Max	Unit
UVC	The peak wavelength	If=30mA	$\lambda_p$	270	275	280	nm
	Output Radiated power		$P_{opt}$	--	3.5	--	mW
	Forward Voltage		$V_f$	5	5.5	7.5	V
	FWHM		$\Delta \lambda$	--	9	--	nm
	Viewing Angle		$2\theta_{1/2}$	--	120	--	°
	Output Radiated power	If=60mA	$P_{opt}$	--	5.5	--	mW
UVA	The peak wavelength	If=60mA	$\lambda_p$	395	400	405	nm
	Output Radiated power		$P_{opt}$	40	--	50	mW
	Forward current		$I_f$		60	90	mA
	Forward Voltage		$V_f$	3	3.5	4	V
	FWHM		$\Delta \lambda$	--	14	--	nm

Instructions: Tc = 25°C; The tolerance of Forward voltage:  $\pm 0.1V$ ; The tolerance of Radiation flux:  $\pm 8\%$ ; The tolerance of peak wavelength :  $\pm 3nm$ .

**Limit service condition(UVC)**

Parameter	Symbol	Unit	Range
Forward current	If	mA	$\leq 60$
Junction temperature	Tj	°C	$\leq 90$
Working temperature	Topr	°C	-30-60
The welding conditions	Tsol	-	260°C < 5seconds



Part No.: U3535C1VGB10

Photoelectric parameter curve (UVC) :

Fig.1 Relative Radiant Power VS Forward Current(Ta=25℃) Fig.2 Forward Current VS Forward Voltage (Ta=25℃)

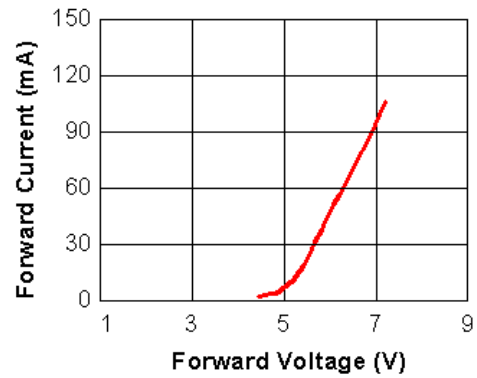
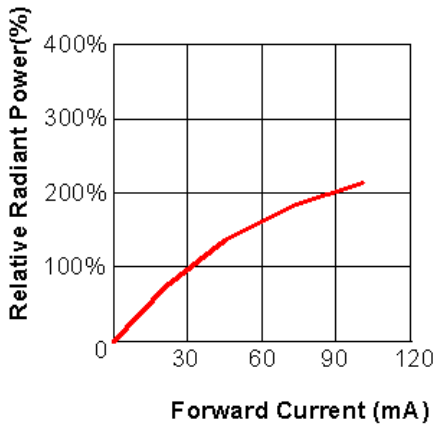

Fig.3 Forward Voltage VS Ambient Temperature

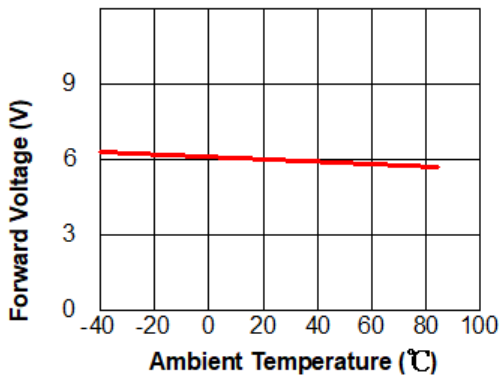
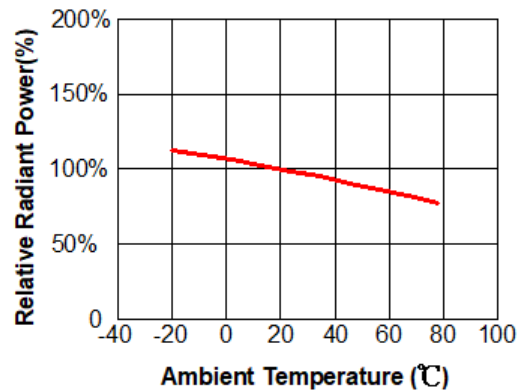

Fig.4 Relative Radiant Power VS Ambient Temperature





Part No.: U3535C1VGB10

Fig.5 Peak Wavelength VS Forward Current

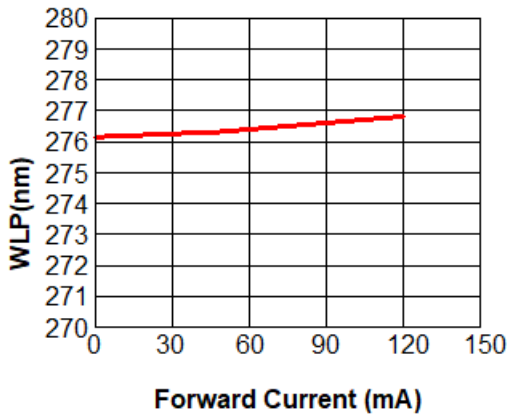

Fig.6 Forward Current VS Ambient Temperature

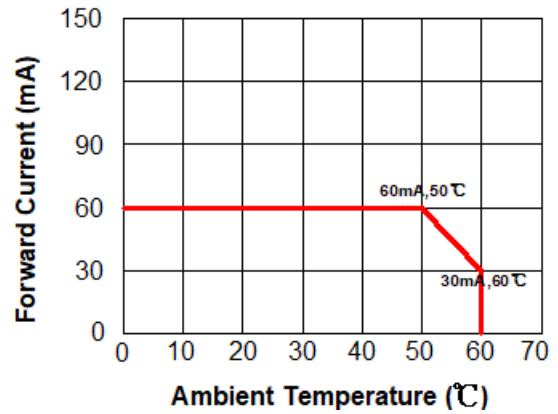

Fig.7 Relative Intensity VS WLP

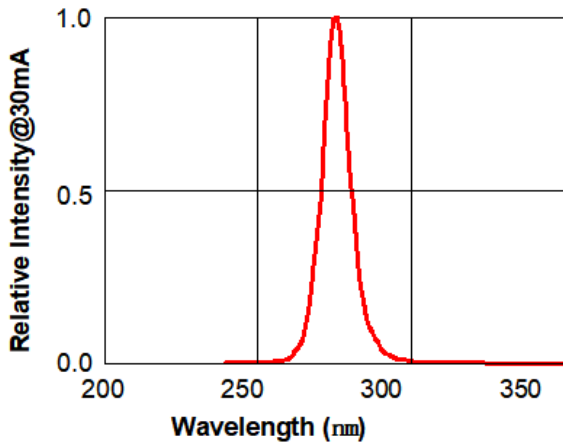
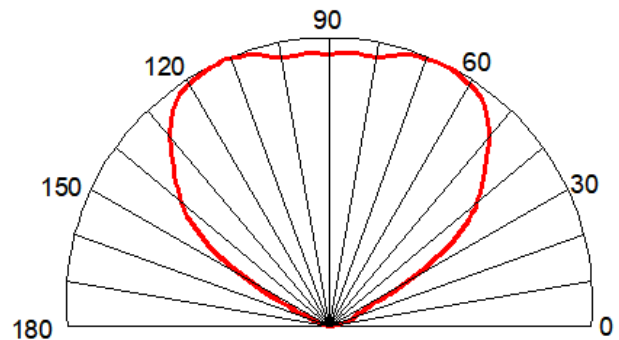

Fig.8 Radiation pattern@30mA





Part No.: U3535C1VGB10

**Packing**

(Unit: mm)

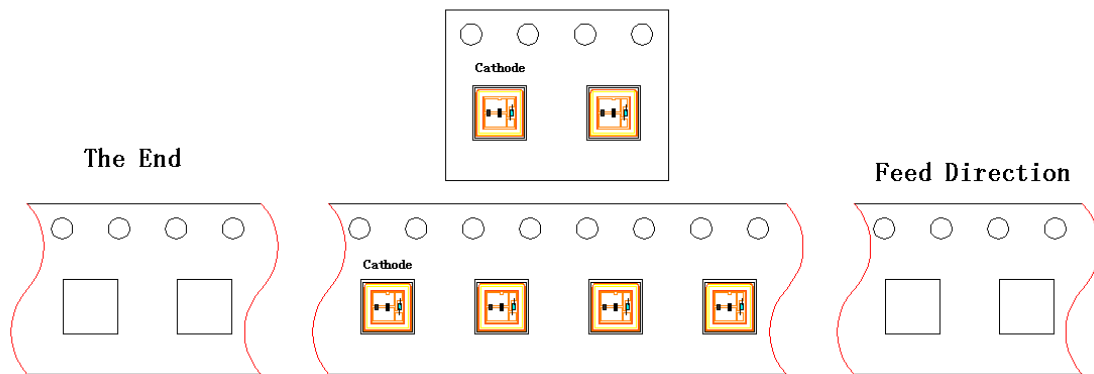
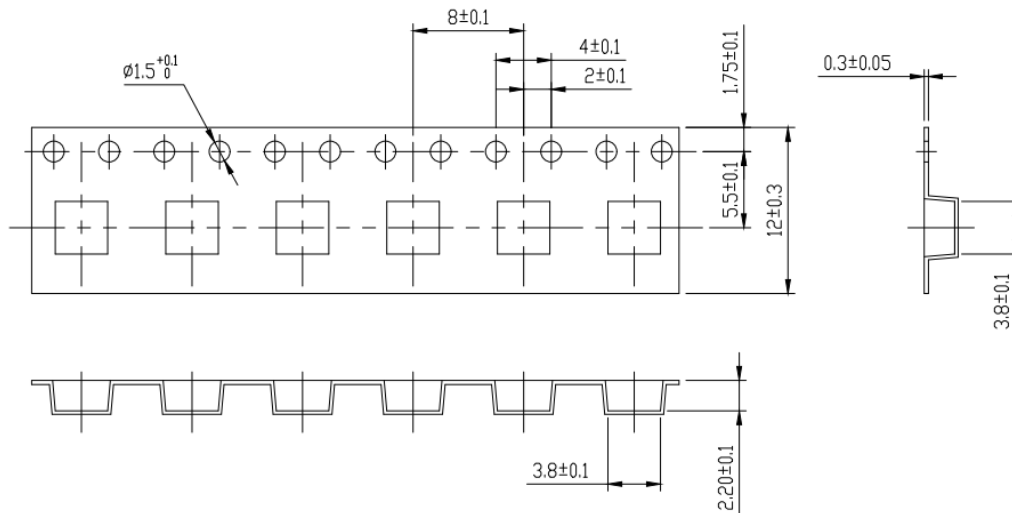

The blank space With 200mm

A roll of 1000PCS

The blank space With 400mm



Part No.: U3535C1VGB10

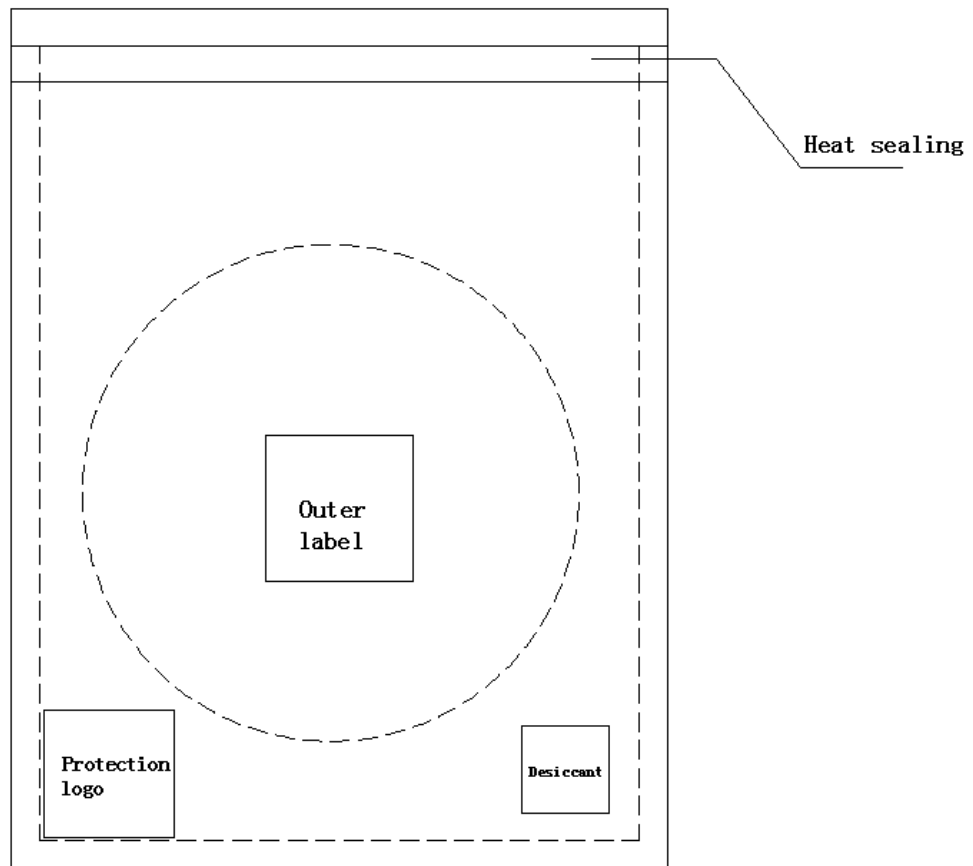
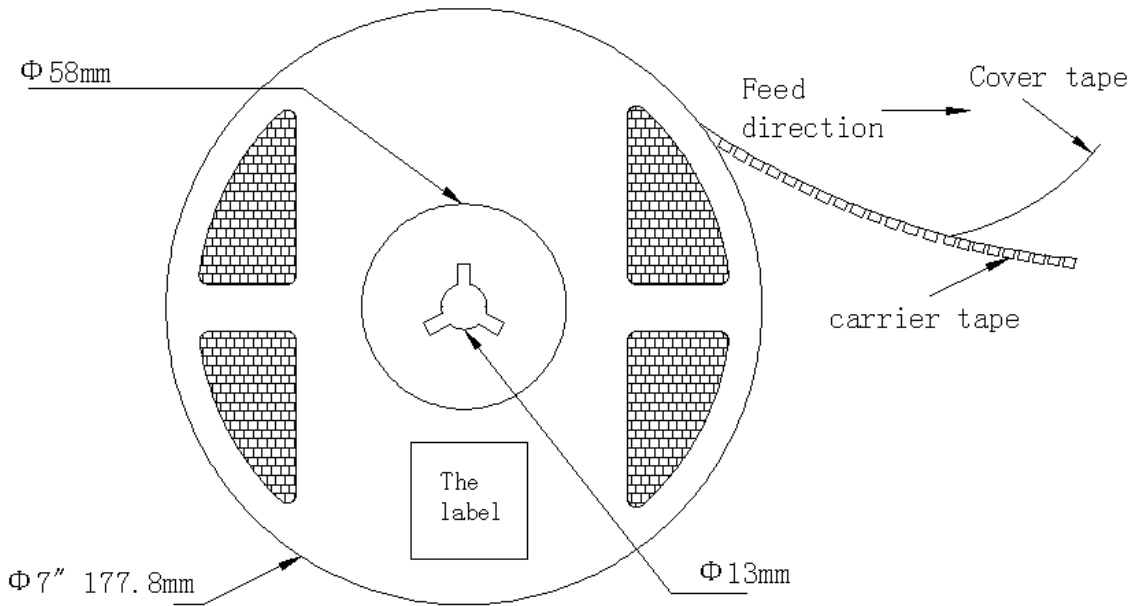

**Notice:** Please refer to the label value for the actual number of products in each roll, but the total number will



not exceed 1000.

**Reliability test**

Test	Test Conditions	Failure Criterion
Normal temperature life test	25°C, 30mA, 1000Hours	Forward voltage, $V_f > 110\%$
High temperature storage	100°C, 1000Hours	
Low temperature storage	-40°C, 1000Hours	
Temperature cycle (100times)	-40°C (30mins) ~ +25°C (5mins) +100°C(30mins) ~ +25°C (5mins)	Radiation power, $P_{opt} < 70\%$

Notice:

Test the device at room temperature

**Recommend suitable temperature curve formula**

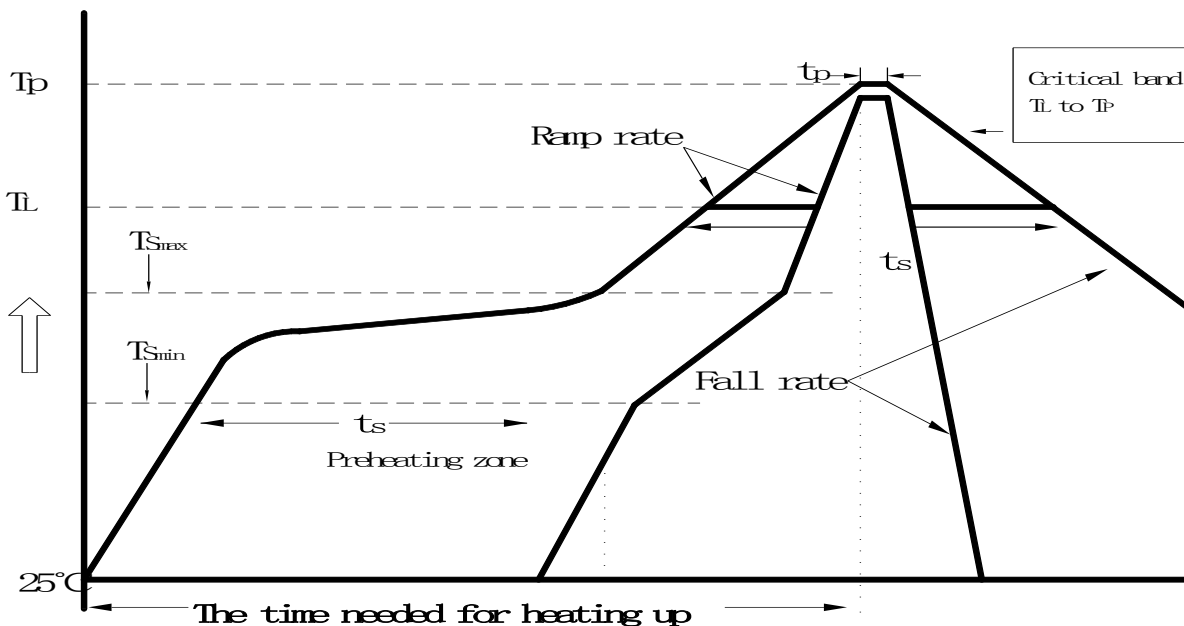





Part No.: U3535C1VGB10

Temperature curve characteristics	Lead-free solder
Ramp rate (T <sub>Smax</sub> to T <sub>P</sub> )	Max 3°C/S
Preheat: minimum temperature(T <sub>Smin</sub> )	150°C
Prehea: maximum temperature(T <sub>Smax</sub> )	200°C
Maintain a higher temperature: temperature (T <sub>L</sub> )	60-180 S
Liquid temperature (T <sub>L</sub> )	217°C
Maintain a higher temperature: time (T <sub>L</sub> )	60-150 S
T <sub>p</sub> /temperature	260°C
Specify the time within 5°C of the actual peak temperature	20-40 S
The slope rate (T <sub>p</sub> to T <sub>L</sub> )	Max 6°C/S
The time needed for heating up to theT <sub>p</sub> of 25 °C	Max 8 min