

DAISY-28X1-WW

~80° wide beam. Variant with 4X1 lenses.

TECHNICAL SPECIFICATIONS:

Dimensions	1140.0 x 40.0 mm
Height	20.2 mm
Fastening	pin, screw, clips
ROHS compliant	yes ⓘ

MATERIAL SPECIFICATIONS:

Component	Type	Material	Colour	Finish
C16584_DAISY-4X1-WW	Linear lens	PMMA	clear	
C16585_DAISY-28X1-SHD	Shade	PC-ABS	black	gloss
C16783_DAISY-28X1-SHD-WHT	Shade	PC	white	gloss
C17481_DAISY-28X1-SHD-MATT	Shade	PC	black	matt
C17482_DAISY-28X1-SHD-WHT-MATT	Shade	PC	white	matt
C17527_DAISY-28X1-SHD-MET	Shade	PC	metal	gloss
C17537_DAISY-28X1-SHD-MET-MATT	Shade	PC	metal	matt

ORDERING INFORMATION:

Quantities for one set:

Linear lens	7
Shade	1



Component		Qty in box	MOQ	MPQ	Box weight (kg)
C16584_DAISY-4X1-WW » Box size: 480 x 280 x 300 mm	Linear lens	504	336	21	5.6
C16783_DAISY-28X1-SHD-WHT » Box size: 1185 x 385 x 140 mm	Shade	48	48	48	8.0
C17537_DAISY-28X1-SHD-MET-MATT » Box size: 1185 x 385 x 140 mm	Shade	48	48	48	8.3
C17481_DAISY-28X1-SHD-MATT » Box size: 1185 x 385 x 140 mm	Shade	48	48	48	8.2
C17482_DAISY-28X1-SHD-WHT-MATT » Box size: 1185 x 385 x 140 mm	Shade	48	48	48	8.7
C16585_DAISY-28X1-SHD » Box size: 1185 x 385 x 140 mm	Shade	48	48	48	8.4
C17527_DAISY-28X1-SHD-MET » Box size: 1185 x 385 x 140 mm	Shade	48	48	48	8.6

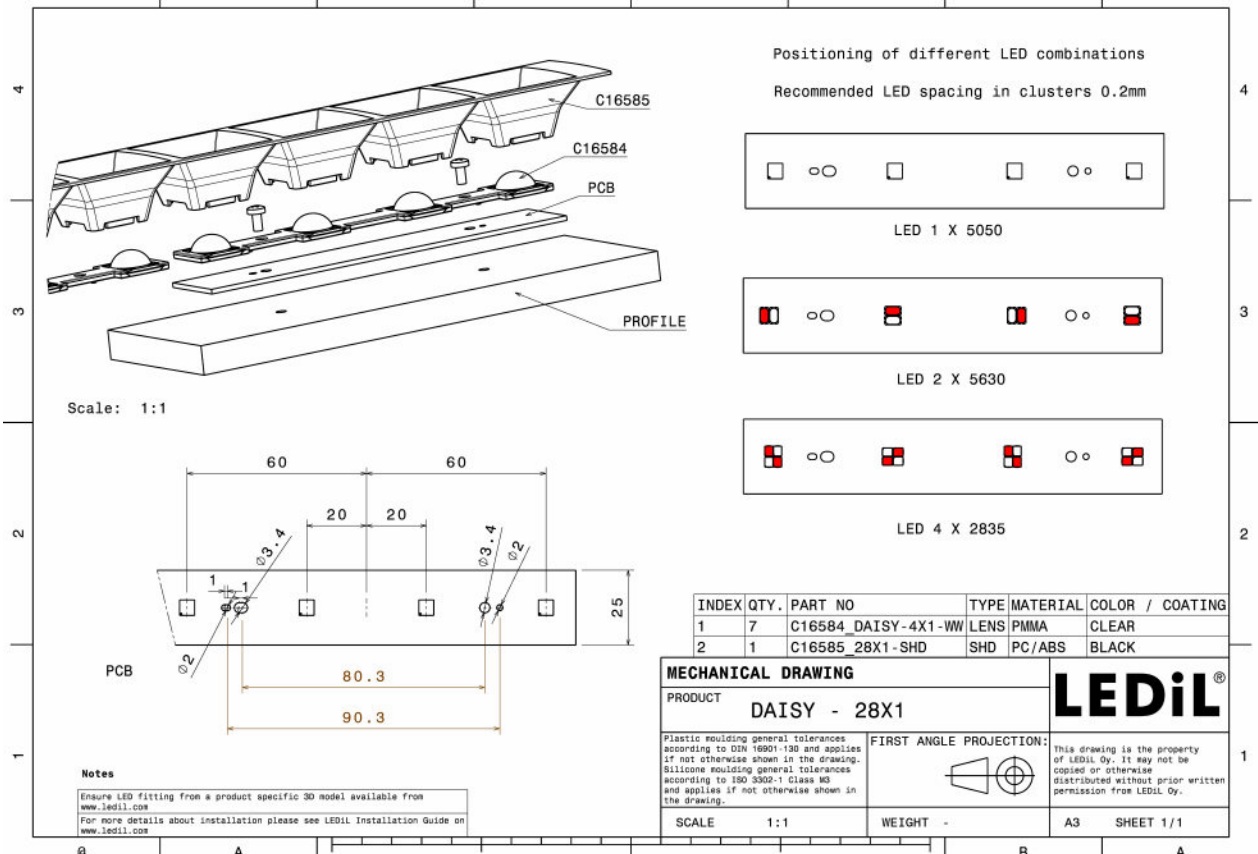
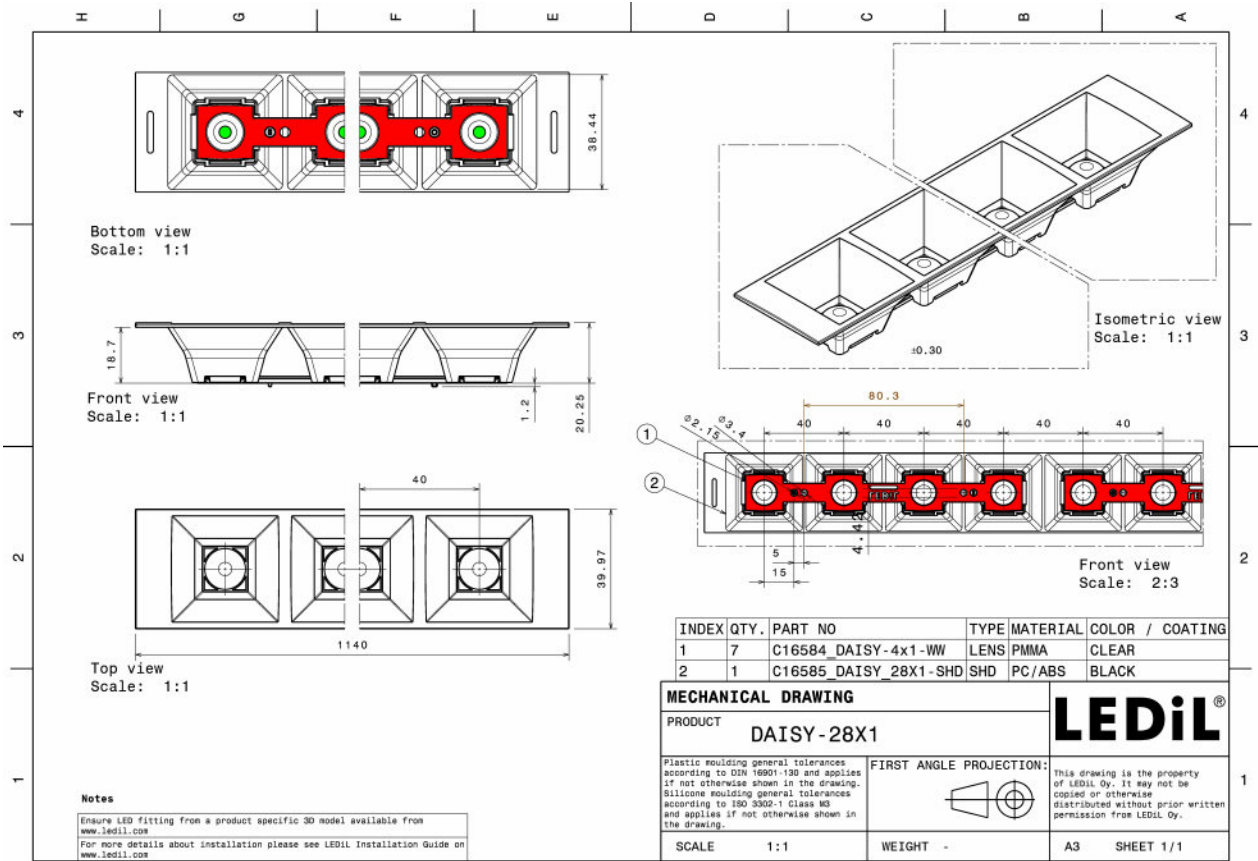

See also our general installation guide: www.ledil.com/installation_guide

PHOTOMETRIC DATA (MEASURED):



LED LIGHT ENGINE DAISY 112 LEDs 1,140mm x 20mm
 FWHM / FWTM 75.0° / 87.0°
 Efficiency 94 %
 Peak intensity 0.7 cd/m
 LEDs/each optic 4
 Light colour White
 Required components:
 C17537_DAISSY-28X1-SHD-MET-MATT

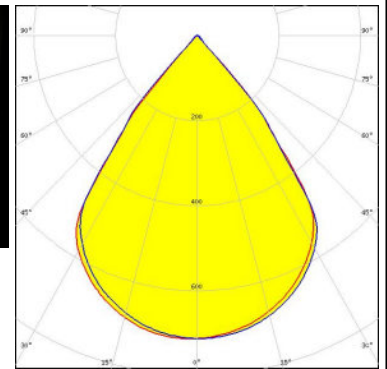
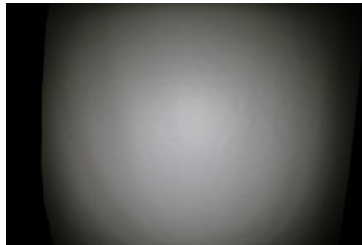

LED LIGHT ENGINE DAISY 112 LEDs 1,140mm x 20mm
 FWHM / FWTM 74.0° / 87.0°
 Efficiency 96 %
 Peak intensity 0.7 cd/m
 LEDs/each optic 4
 Light colour White
 Required components:
 C17527_DAISSY-28X1-SHD-MET

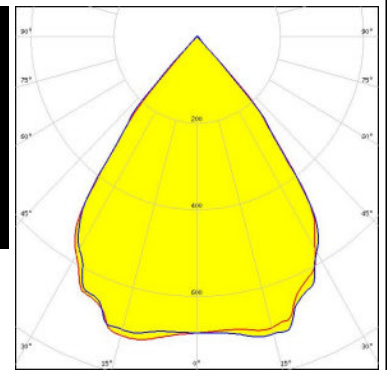
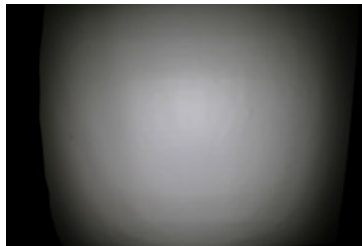

LED LIGHT ENGINE DAISY 112 LEDs 1,140mm x 20mm
 FWHM / FWTM 76.0° / 87.5°
 Efficiency 95 %
 Peak intensity 0.7 cd/m
 LEDs/each optic 4
 Light colour White
 Required components:
 C17482_DAISSY-28X1-SHD-WHT-MATT

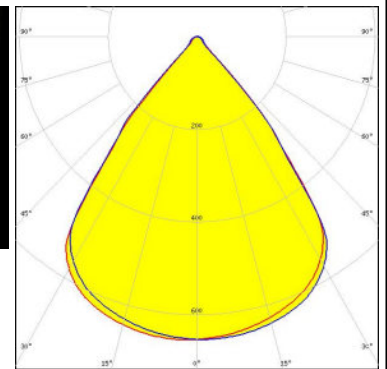
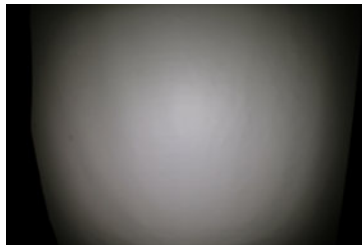

LED LIGHT ENGINE DAISY 112 LEDs 1,140mm x 20mm
 FWHM / FWTM 76.0° / 87.0°
 Efficiency 86 %
 Peak intensity 0.6 cd/m
 LEDs/each optic 4
 Light colour White
 Required components:
 C17481_DAISSY-28X1-SHD-MATT

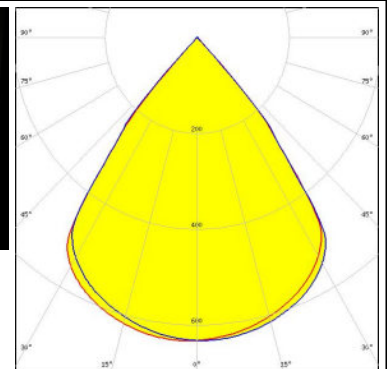
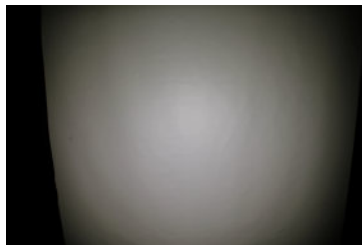

PHOTOMETRIC DATA (MEASURED):



LED LIGHT ENGINE DAISY 112 LEDs 1,140mm x 20mm
 FWHM / FWTM 76.0° / 87.5°
 Efficiency 95 %
 Peak intensity 0.7 cd/lm
 LEDs/each optic 1
 Light colour White
 Required components:
 C16783_DAISY-28X1-SHD-WHT

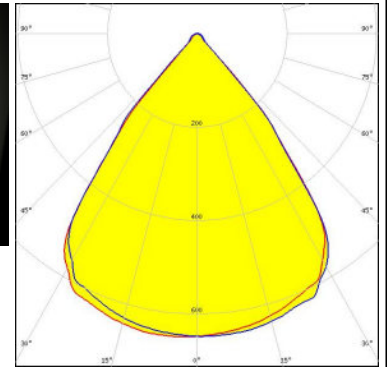

LED LIGHT ENGINE DAISY 112 LEDs 1,140mm x 20mm
 FWHM / FWTM 76.0° / 87.0°
 Efficiency 87 %
 Peak intensity 0.6 cd/lm
 LEDs/each optic 4
 Light colour White
 Required components:
 C16585_DAISY-28X1-SHD

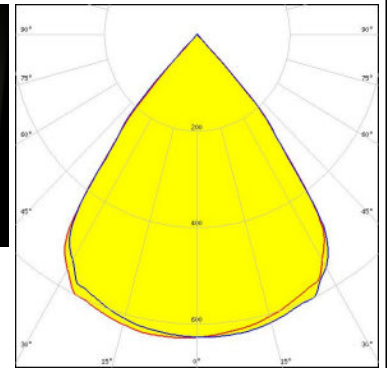
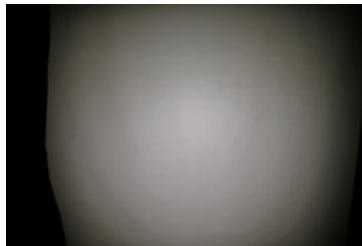

LED J Series 2835
 FWHM / FWTM 77.0° / 86.0°
 Efficiency 87 %
 Peak intensity 0.6 cd/lm
 LEDs/each optic 2
 Light colour White
 Required components:
 C16585_DAISY-28X1-SHD

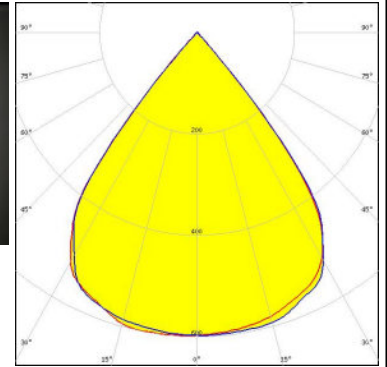

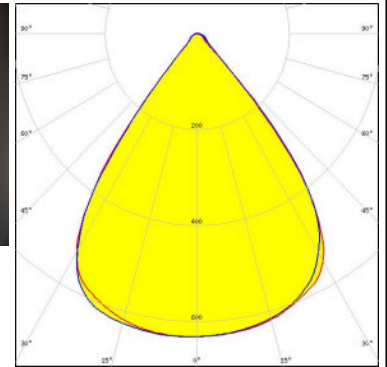
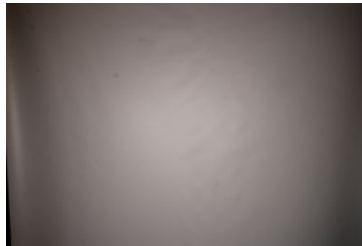

LED LDL-iC-562-827-2000lm
 FWHM / FWTM 75.0° / 88.0°
 Efficiency 92 %
 Peak intensity 0.6 cd/lm
 LEDs/each optic 1
 Light colour White
 Required components:
 C16783_DAISY-28X1-SHD-WHT



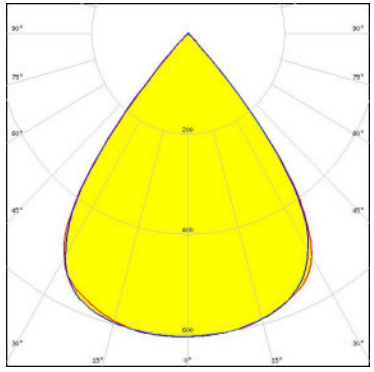
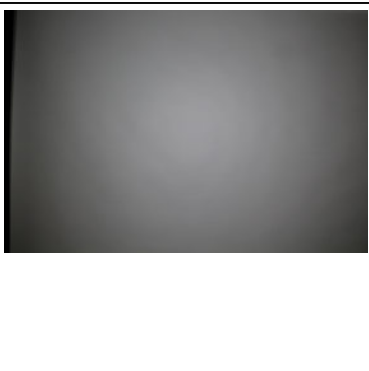
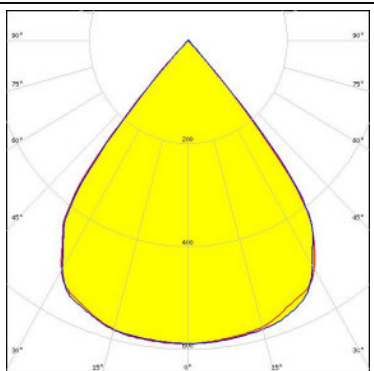
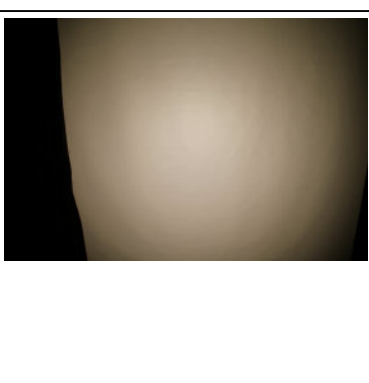
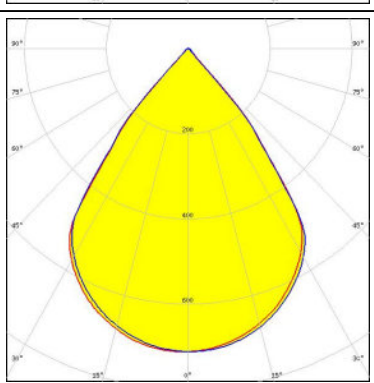
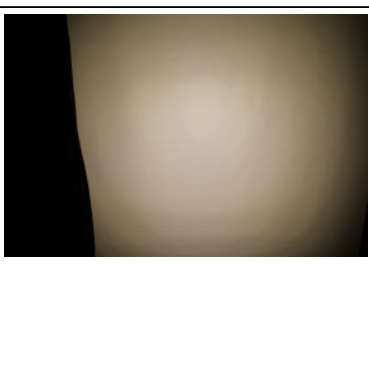
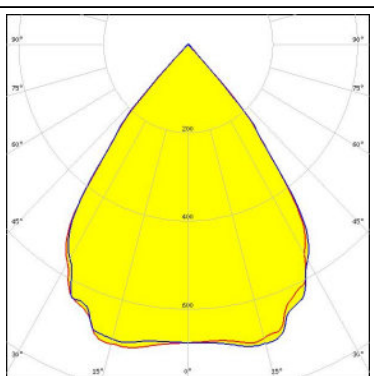

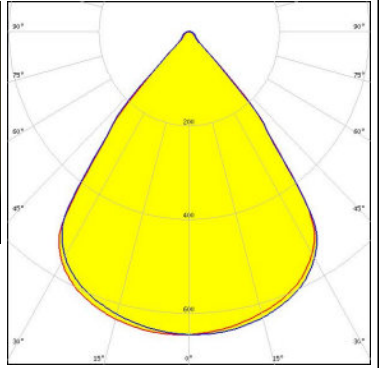
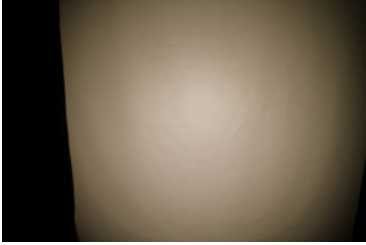
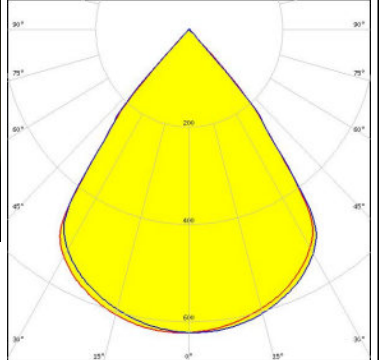

PHOTOMETRIC DATA (MEASURED):

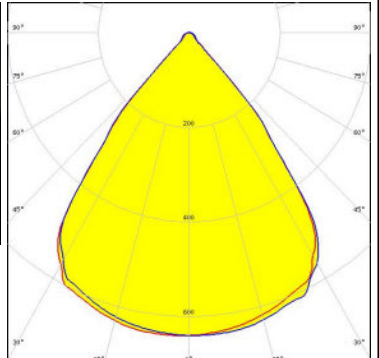
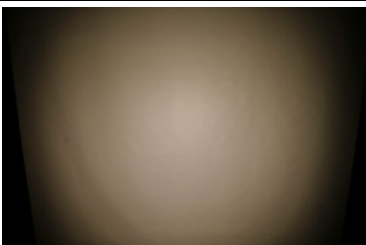
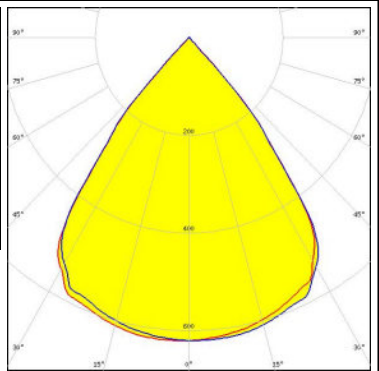
<p>Helvar</p> <p>LED LDL-iC-562-827-2000lm FWHM / FWTM 75.0° / 86.0° Efficiency 83 % Peak intensity 0.6 cd/lm LEDs/each optic 1 Light colour White Required components: C16585_DAISSY-28X1-SHD</p>		
<p>LUMILEDS</p> <p>LED LUXEON 2835 Line FWHM / FWTM 78.0° / 86.0° Efficiency 87 % Peak intensity 0.6 cd/lm LEDs/each optic 2 Light colour White Required components: C16585_DAISSY-28X1-SHD</p>		
<p>MST <i>Your solutions</i></p> <p>LED LinLED 1120x28mm 2200lm 8x0 2C 84V Opt G1 FWHM / FWTM 74.5° / 87.5° Efficiency 94 % Peak intensity 0.7 cd/lm LEDs/each optic 2 Light colour White Required components: C17537_DAISSY-28X1-SHD-MET-MATT</p>		
<p>MST <i>Your solutions</i></p> <p>LED LinLED 1120x28mm 2200lm 8x0 2C 84V Opt G1 FWHM / FWTM 74.5° / 87.5 + 87.0° Efficiency 95 % Peak intensity 0.7 cd/lm LEDs/each optic 2 Light colour White Required components: C17527_DAISSY-28X1-SHD-MET</p>		



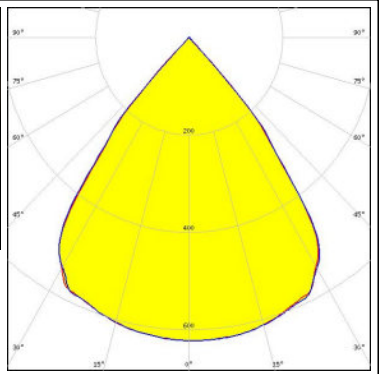
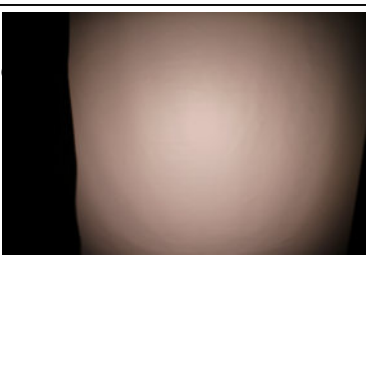
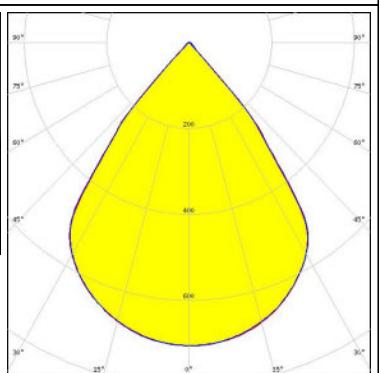

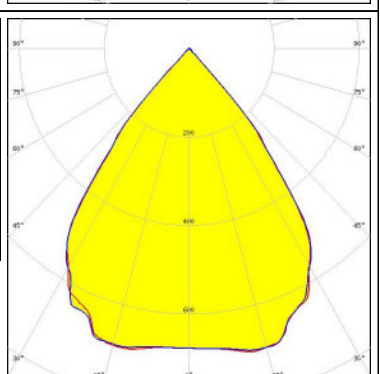
PHOTOMETRIC DATA (MEASURED):

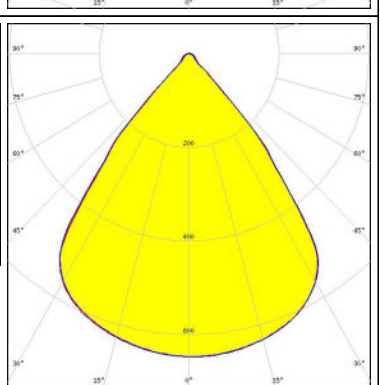
<p>MST <i>Your solutions</i></p> <p>LED LinLED 1120x28mm 2200lm 8x0 2C 84V Opt G1 FWHM / FWTM 76.0 + 76.5° / 88.0° Efficiency 94 % Peak intensity 0.6 cd/lm LEDs/each optic 2 Light colour White Required components: C17482_DAISSY-28X1-SHD-WHT-MATT</p>		
<p>MST <i>Your solutions</i></p> <p>LED LinLED 1120x28mm 2200lm 8x0 2C 84V Opt G1 FWHM / FWTM 75.5 + 76.0° / 87.5° Efficiency 85 % Peak intensity 0.6 cd/lm LEDs/each optic 2 Light colour White Required components: C17481_DAISSY-28X1-SHD-MATT</p>		
<p>MST <i>Your solutions</i></p> <p>LED LinLED 1120x28mm 2200lm 8x0 2C 84V Opt G1 FWHM / FWTM 76.5° / 88.5 + 88.0° Efficiency 94 % Peak intensity 0.6 cd/lm LEDs/each optic 2 Light colour White Required components: C16783_DAISSY-28X1-SHD-WHT</p>		
<p>MST <i>Your solutions</i></p> <p>LED LinLED 1120x28mm 2200lm 8x0 2C 84V Opt G1 FWHM / FWTM 76.0 + 75.5° / 87.5 + 87.0° Efficiency 86 % Peak intensity 0.6 cd/lm LEDs/each optic 2 Light colour White Required components: C16585_DAISSY-28X1-SHD</p>		



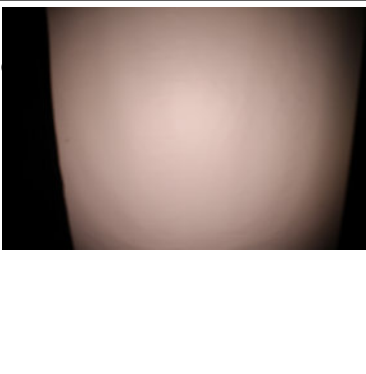
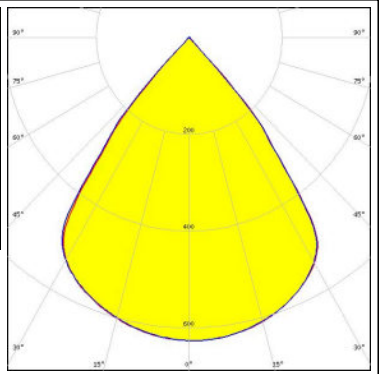
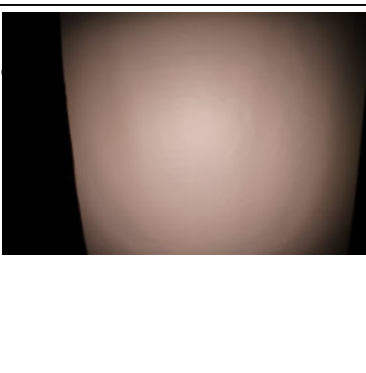
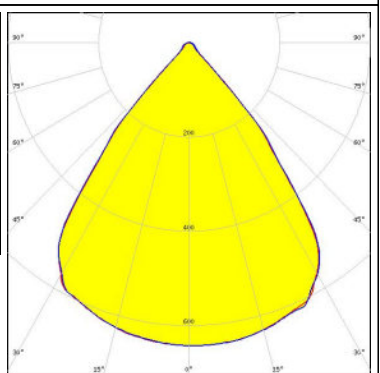

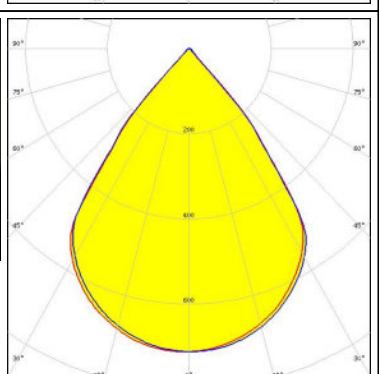
PHOTOMETRIC DATA (MEASURED):

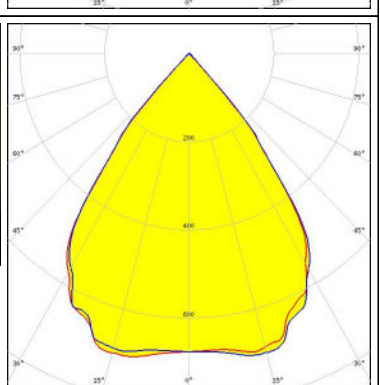
<p>MST <i>Your solutions</i></p> <p>LED LinLED 1120x28mm 2x2200lm 827-865 2x2C 84V DAISY</p> <p>FWHM / FWTM 76.0 + 76.5° / 87.5°</p> <p>Efficiency 87 %</p> <p>Peak intensity 0.6 cd/lm</p> <p>LEDs/each optic 4</p> <p>Light colour Tunable White</p> <p>Required components: C16585_DAISY-28X1-SHD</p>		
<p>MST <i>Your solutions</i></p> <p>LED LinLED 1120x28mm 2x2200lm 827-865 2x2C 84V DAISY</p> <p>FWHM / FWTM 75.5° / 88.0 + 87.5°</p> <p>Efficiency 94 %</p> <p>Peak intensity 0.7 cd/lm</p> <p>LEDs/each optic 4</p> <p>Light colour Tunable White</p> <p>Required components: C17537_DAISY-28X1-SHD-MET-MATT</p>		
<p>MST <i>Your solutions</i></p> <p>LED LinLED 1120x28mm 2x2200lm 827-865 2x2C 84V DAISY</p> <p>FWHM / FWTM 74.5 + 75.5° / 87.5°</p> <p>Efficiency 95 %</p> <p>Peak intensity 0.7 cd/lm</p> <p>LEDs/each optic 4</p> <p>Light colour Tunable White</p> <p>Required components: C17527_DAISY-28X1-SHD-MET</p>		
<p>MST <i>Your solutions</i></p> <p>LED LinLED 1120x28mm 2x2200lm 827-865 2x2C 84V DAISY</p> <p>FWHM / FWTM 76.5 + 77.0° / 88.5°</p> <p>Efficiency 95 %</p> <p>Peak intensity 0.6 cd/lm</p> <p>LEDs/each optic 4</p> <p>Light colour Tunable White</p> <p>Required components: C17482_DAISY-28X1-SHD-WHT-MATT</p>		

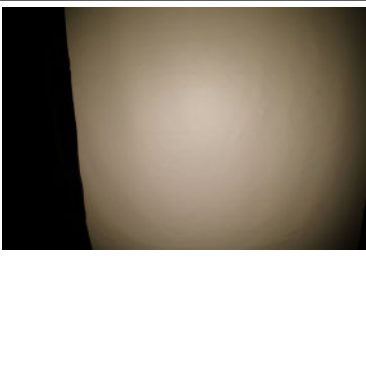
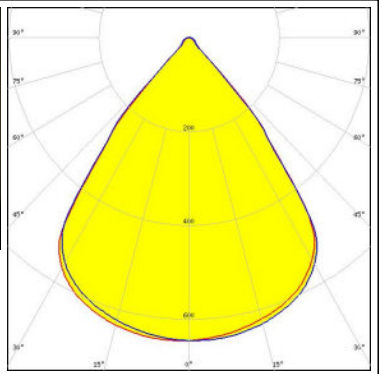
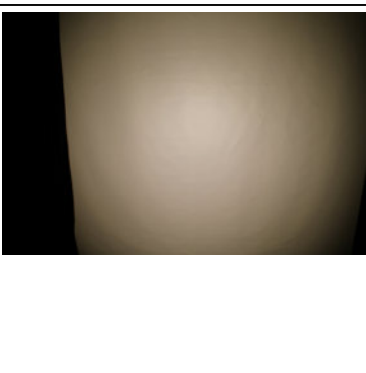
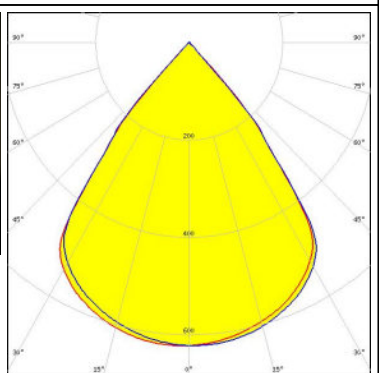

PHOTOMETRIC DATA (MEASURED):

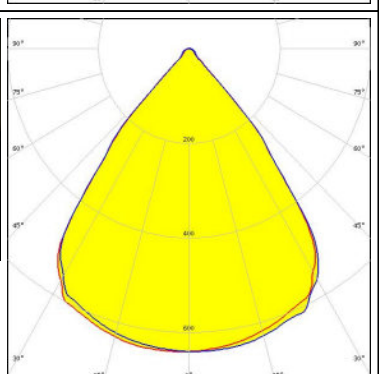
<p>MST <i>Your solutions</i></p> <p>LED LinLED 1120x28mm 2x2200lm 827-865 2x2C 84V DAISY</p> <p>FWHM / FWTM 76.0 + 76.5° / 87.5°</p> <p>Efficiency 86 %</p> <p>Peak intensity 0.6 cd/lm</p> <p>LEDs/each optic 4</p> <p>Light colour Tunable White</p> <p>Required components: C17481_DAISSY-28X1-SHD-MATT</p>		
<p>MST <i>Your solutions</i></p> <p>LED LinLED 1120x28mm 2x2200lm 827-865 2x2C 84V DAISY</p> <p>FWHM / FWTM 76.5 + 77.0° / 88.5°</p> <p>Efficiency 95 %</p> <p>Peak intensity 0.6 cd/lm</p> <p>LEDs/each optic 4</p> <p>Light colour Tunable White</p> <p>Required components: C16783_DAISSY-28X1-SHD-WHT</p>		
<p>MST <i>Your solutions</i></p> <p>LED LinLED 1120x28mm 4400lm 8x0 2C 84V Opt G1</p> <p>FWHM / FWTM 74.5° / 87.5°</p> <p>Efficiency 94 %</p> <p>Peak intensity 0.7 cd/lm</p> <p>LEDs/each optic 4</p> <p>Light colour White</p> <p>Required components: C17537_DAISSY-28X1-SHD-MET-MATT</p>		
<p>MST <i>Your solutions</i></p> <p>LED LinLED 1120x28mm 4400lm 8x0 2C 84V Opt G1</p> <p>FWHM / FWTM 74.5° / 87.5 + 87.0°</p> <p>Efficiency 95 %</p> <p>Peak intensity 0.7 cd/lm</p> <p>LEDs/each optic 4</p> <p>Light colour White</p> <p>Required components: C17527_DAISSY-28X1-SHD-MET</p>		

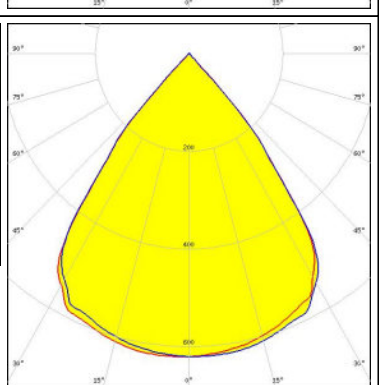



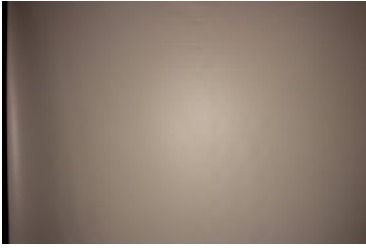
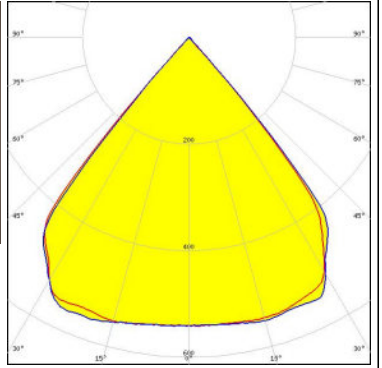
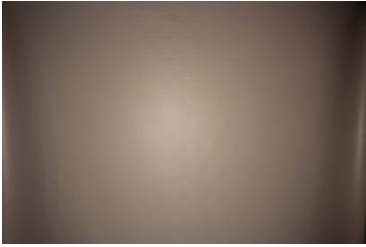
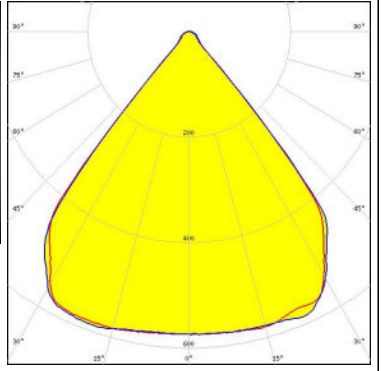
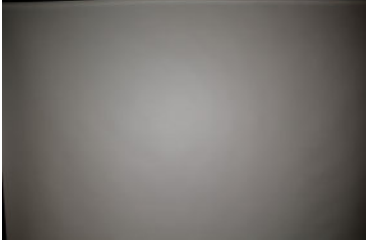
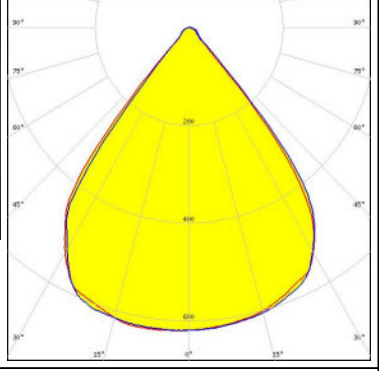

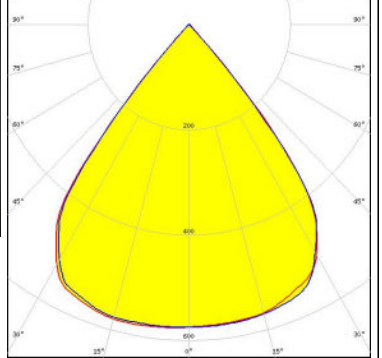
PHOTOMETRIC DATA (MEASURED):

<p>MST <i>Your solutions</i></p> <p>LED LinLED 1120x28mm 4400lm 8x0 2C 84V Opt G1 FWHM / FWTM 76.0 + 76.5° / 88.0° Efficiency 94 % Peak intensity 0.6 cd/lm LEDs/each optic 4 Light colour White Required components: C17482_DAISSY-28X1-SHD-WHT-MATT</p>		
<p>MST <i>Your solutions</i></p> <p>LED LinLED 1120x28mm 4400lm 8x0 2C 84V Opt G1 FWHM / FWTM 75.5 + 76.0° / 87.5° Efficiency 85 % Peak intensity 0.6 cd/lm LEDs/each optic 4 Light colour White Required components: C17481_DAISSY-28X1-SHD-MATT</p>		
<p>MST <i>Your solutions</i></p> <p>LED LinLED 1120x28mm 4400lm 8x0 2C 84V Opt G1 FWHM / FWTM 76.5° / 88.5 + 88.0° Efficiency 94 % Peak intensity 0.6 cd/lm LEDs/each optic 4 Light colour White Required components: C16783_DAISSY-28X1-SHD-WHT</p>		
<p>MST <i>Your solutions</i></p> <p>LED LinLED 1120x28mm 4400lm 8x0 2C 84V Opt G1 FWHM / FWTM 76.0 + 75.5° / 87.5 + 87.0° Efficiency 86 % Peak intensity 0.6 cd/lm LEDs/each optic 4 Light colour White Required components: C16585_DAISSY-28X1-SHD</p>		

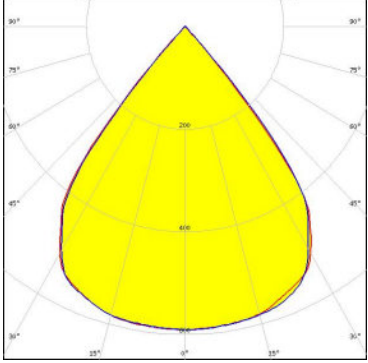
PHOTOMETRIC DATA (MEASURED):

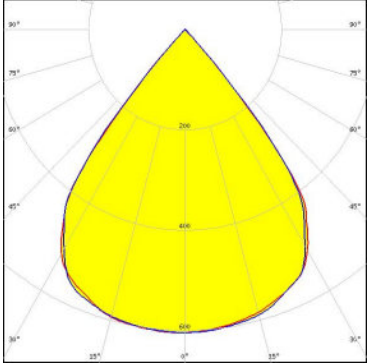
<p>NICHIA</p> <p>LED NF2W757G-MT (Tunable White) FWHM / FWTM 79.0° / 85.0° Efficiency 86 % Peak intensity 0.6 cd/m LEDs/each optic 1 Light colour Tunable White Required components: C16585_DAISSY-28X1-SHD</p>		
<p>NICHIA</p> <p>LED NF2W757G-MT (Tunable White) FWHM / FWTM 80.0° / 86.0° Efficiency 97 % Peak intensity 0.6 cd/m LEDs/each optic 1 Light colour Tunable White Required components: C16783_DAISSY-28X1-SHD-WHT</p>		
<p>SAMSUNG</p> <p>LED LM28xB Series FWHM / FWTM 77.0° / 87.0° Efficiency 94 % Peak intensity 0.6 cd/m LEDs/each optic 2 Light colour White Required components: C16783_DAISSY-28X1-SHD-WHT</p>		
<p>SAMSUNG</p> <p>LED LM28xB Series FWHM / FWTM 78.0° / 86.0° Efficiency 84 % Peak intensity 0.6 cd/m LEDs/each optic 2 Light colour White Required components: C16585_DAISSY-28X1-SHD</p>		

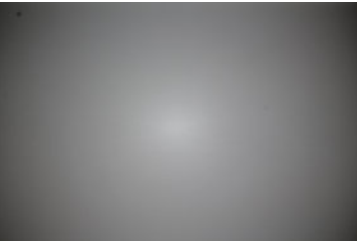
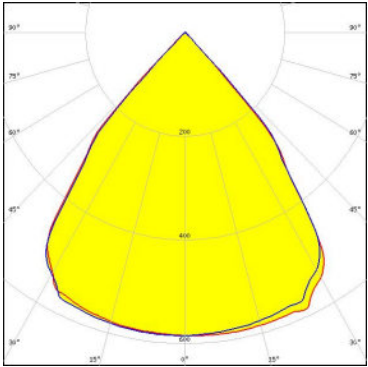
PHOTOMETRIC DATA (MEASURED):

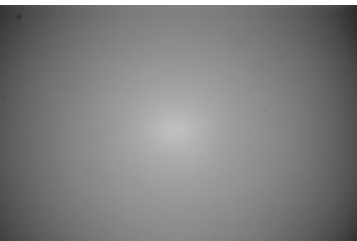
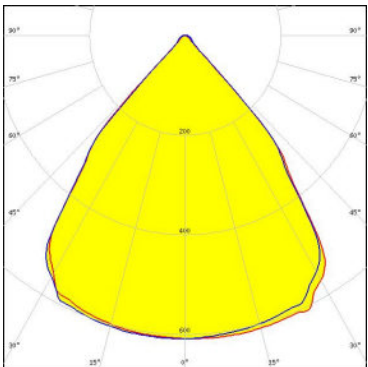
<p> SEOUL SEMICONDUCTOR</p> <p>LED: SEOUL DC 3528 FWHM / FWTM: 78.0° / 86.0° Efficiency: 87 % Peak intensity: 0.6 cd/m LEDs/each optic: 2 Light colour: White Required components: C16585_DAISSY-28X1-SHD</p>		
<p> SEOUL SEMICONDUCTOR</p> <p>LED: SEOUL DC 3528 FWHM / FWTM: 77.0° / 86.0° Efficiency: 87 % Peak intensity: 0.6 cd/m LEDs/each optic: 2 Light colour: White Required components: C16585_DAISSY-28X1-SHD</p>		
<p> TEPCOMP group</p> <p>LED: PassivePAQ-L-2F35-SSA3-5.4K-840-3-DC FWHM / FWTM: 81.0° / 90.0° Efficiency: 86 % Peak intensity: 0.6 cd/m LEDs/each optic: 4 Light colour: White Required components: C16585_DAISSY-28X1-SHD</p>		
<p> TEPCOMP group</p> <p>LED: PassivePAQ-L-2F35-SSA3-5.4K-840-3-DC FWHM / FWTM: 82.0° / 90.0° Efficiency: 94 % Peak intensity: 0.6 cd/m LEDs/each optic: 4 Light colour: White Required components: C16783_DAISSY-28X1-SHD-WHT</p>		

PHOTOMETRIC DATA (MEASURED):

TRIDONIC

LED LLE 24x280mm 750lm 8x0 LVD ADV1
FWHM / FWMTM 77.0° / 88.0°
Efficiency 94 %
Peak intensity 0.6 cd/lm
LEDs/each optic 1
Light colour White
Required components:
C16783_DAISY-28X1-SHD-WHT

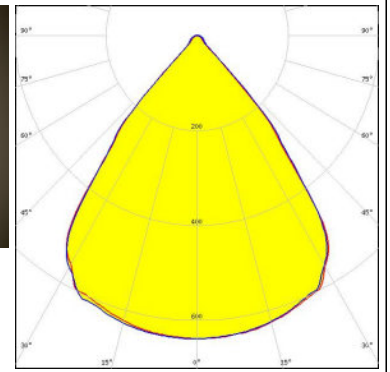

PHOTOMETRIC DATA (SIMULATED):



LED XD16
 FWHM / FWTM 76.0° / 93.0°
 Efficiency 88 %
 Peak intensity 0.6 cd/lm
 LEDs/each optic 1
 Light colour White
 Required components:
 C16585_DAISY-28X1-SHD

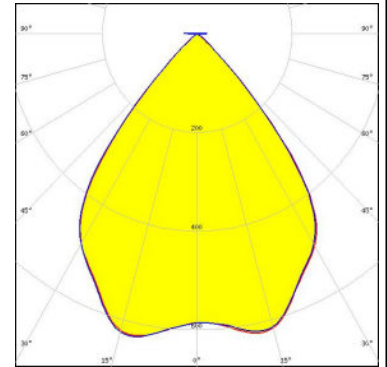

LED NF2W757G-MT (Tunable White)
 FWHM / FWTM 76.0° / 88.0°
 Efficiency 90 %
 Peak intensity 0.7 cd/lm
 LEDs/each optic 4
 Light colour Tunable White
 Required components:
 C16585_DAISY-28X1-SHD

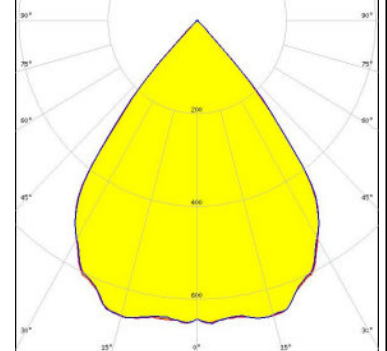

LED NF2W757G-MT (Tunable White)
 FWHM / FWTM 76.0 + 78.0° / 86.0°
 Efficiency 90 %
 Peak intensity 0.7 cd/lm
 LEDs/each optic 2
 Light colour Tunable White
 Required components:
 C16585_DAISY-28X1-SHD

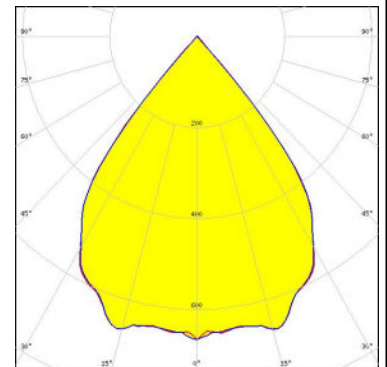

LED NVSxx19B/NVSxx19C
 FWHM / FWTM 79.2° / 94.2°
 Efficiency 87 %
 Peak intensity 0.6 cd/lm
 LEDs/each optic 1
 Light colour White
 Required components:
 C16585_DAISY-28X1-SHD

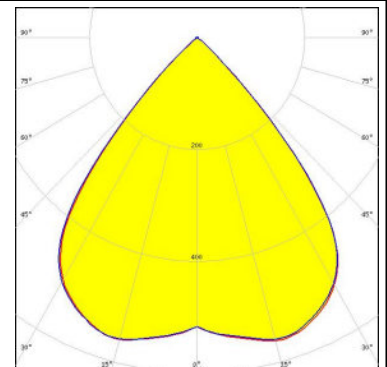

GENERAL INFORMATION:

NOTE: The typical beam angle will be changed by different color, chip size and chip position tolerance. The typical total beam angle is the full angle measured where the luminous intensity is half of the peak value.

MATERIALS:

As part of our continuous research and improvement processes, and to ensure the best possible quality and availability of our products, LEDiL reserves the right to change material grades without notice.

PRODUCT DATA USER AGREEMENT AND DISCLAIMER:

The measured data in the provided downloadable LEDiL Product Datasheets and Mechanical 2D-Drawings is rounded and provided as reference for planning. LEDiL Oy's optical specifications have been verified by conducting performance testing of the products in accordance with the company's quality system. The reported data are averaged results of multiple measurements with typical variation. LEDiL Oy reserves the right to without prior notification make changes and improvements to its products.

LEDiL Oy assumes neither warranty, nor guarantee nor any other liability of any kind for the contents and correctness of the provided data. The provided data has been generated with highest diligence but the provided data may in reality not represent the complete possible variation range of all intrinsic parameters. Therefore, in certain cases a deviation from the provided data could occur.

LEDiL Oy reserves the right to undertake technical changes of its products without further notification which could lead to changes in the provided data. LEDiL Oy assumes no liability of any kind for the possible deviation from any provided data or any other damage resulting from the usage of the provided data.

The user agrees to this disclaimer and user agreement with the download or usage of the provided files.

LEDiL Oy

Joensuunkatu 13
FI-24240 SALO
Finland

LEDiL Inc.

228 West Page Street
Suite D
Sycamore IL 60178
USA

Ledil Optics Technology (Shenzhen) Co., Ltd.

405 , Block B
Casic Motor Building
Shenzhen 518057
P.R.CHINA

Local sales and technical support

[www.ledil.com/
where_to_buy](http://www.ledil.com/where_to_buy)

Shipping locations

Salo, Finland
Hong Kong, China

Distribution Partners

[www.ledil.com/
where_to_buy](http://www.ledil.com/where_to_buy)