

HF171F

MINIATURE HIGH POWER RELAY



File No.:E133481



File No.:40048577



File No.:17002177419



Features

- * 8A switching capability
- * 1 form A and 1 form C configurations
- * High sensitivity 200mW
- * Creepage/clearance distance:>6mm,meets VDE 0631reinforce insulation
- * 5KV dielectric between coil to contacts
- * Class F insulation
- * Outline Dimensions: 20.0mm x 10mmx 10.6mm

CONTACT DATA

Contact arrangement	1A	1C
Contact resistance ¹⁾	100mΩ max.(at 1A 6VDC)	
Contact material	AgSnO ₂ AgNi	
Contact rating (Res. load)	1A	1C
	6A 250VAC	NO 250VAC 5A 250VAC
	6A 30VDC	6A 30VDC 5A 30VDC
Max. switching voltage	30VDC / 277VAC	
Max. switching current	8A	
Max. switching power	180W/1662VA	
Mechanical endurance	1 x 10 ⁷ OPS	
Electrical endurance	1 x 10 ⁵ OPS(Resistive load, Room temp., 1.5s on 1.5s off)	

Notes: 1)The data shown above are initial values.

CHARACTERISTICS

Insulation resistance	1000MΩ (at 500VDC)
Dielectric strength	Between coil & contacts 5000VAC 1min
	Between open contacts 1000VAC 1min
Surge voltage(Between coil & contacts)	10KV(1.2/50*s)
Operate time (at nomi. volt.)	8ms max.
Release time (at nomi. volt.)	5ms max.
Temperature rise (at nomi.volt.)	60K max.
Shock resistance*	Functional 98m/s ²
	Destructive 980m/s ²
Vibration resistance	10Hz to 55Hz 1.5mm DA
Humidity	5% to 85% RH
Ambient temperature	-40°C to 85°C
Termination	PCB
Unit weight	Approx. 4.6g
Construction	Flux proofed

Notes: 1)*Index is not in relay length direction.
2)The data shown above are initial values.

COIL

Coil power	Approx. 200mW
------------	---------------

COIL DATA

at 23°C

Nominal Voltage VDC	Pick-up Voltage VDC ¹⁾ max.	Drop-out Voltage VDC ¹⁾ min.	Max. ²⁾ Allowable Voltage VDC	Coil Resistance Ω
3	2.25	0.30	3.90	45 x (1±10%)
5	3.75	0.50	6.50	125 x (1±10%)
6	4.50	0.60	7.80	180 x (1±10%)
9	6.75	0.90	11.7	405 x (1±10%)
12	9.00	1.20	15.6	720 x (1±10%)
18	13.5	1.80	23.4	1600 x (1±10%)
24	18.0	2.40	31.2	2880 x (1±10%)
36	27.0	3.60	46.8	6480 x (1±10%)
48	36.0	4.80	62.4	11520 x (1±10%)

Notes: 1)The data shown above are initial values.

2) Maximum voltage is refers to the relay coil in a short period of time can bear the biggest values.

SAFETY APPROVAL RATINGS(PENDING)

UL/CUL	1 Form A	8A 250/277VAC Resistive 85°C 6A 250/277VAC Resistive 85°C 5A 30VDC Resistive 85°C 6A 250VAC General purpose 85°C 10A 120VAC General purpose 85°C 1/4HP 240/277VAC Motor 40°C B300 Pilot duty 40°C
	1 Form C	NO:8A 250/277VAC Resistive 85°C NO:6A 250/277VAC Resistive 85°C CO:5A 250/277VAC Resistive 85°C
VDE	1 Form A	8A 250/277VAC Resistive 85°C 6A 250/277VAC Resistive 85°C 6A 30VDC Resistive 85°C AgSnO ₂ 8A 30VDC Resistive 85°C AgSnO ₂
	1 Form C	NO:8A 250/277VAC Resistive 85°C NO:6A 250/277VAC Resistive 85°C NO:6A 30VDC Resistive 85°C AgSnO ₂ NO:8A 30VDC Resistive 85°C AgSnO ₂ CO:5A 250VAC/30VDC Resistive 85°C

Notes: 1) All values unspecified are at room temperature.

2) Only typical loads are listed above. Other load specifications can be available upon request.



HONGFA RELAY

ISO9001, ISO/TS16949, ISO14001, OHSAS18001, IECQ QC 080000 CERTIFIED

2018 Rev. 1.01

ORDERING INFORMATION

Type	HF171F /	12	-H	T	(XXX)
Coil voltage :	3,5,6,9,12,18,24,36,48VDC				
Contact arrangement	H: 1 Form A	Z: 1 Form C			
Construction	T: AgSnO ₂	3: AgNi			
Special code ²⁾	XXX: Customer special requirement	Nil: Standard			

Notes: 1) We recommend flux proofed types for a clean environment (free from contaminations like H₂S,SO₂,NO₂ dust,etc).
 2) The customer special requirement express as special code after evaluating by Hongfa.

OUTLINE DIMENSIONS, WIRING DIAGRAM AND PC BOARD LAYOUT

Unit: mm

Outline Dimensions

1 Form A

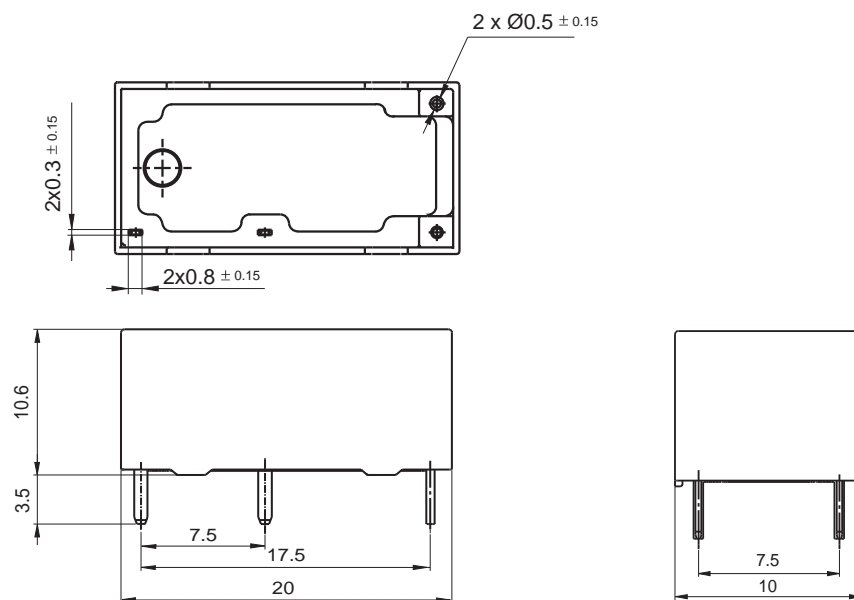

Outline Dimensions

1 Form C

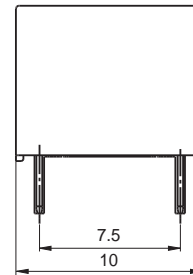
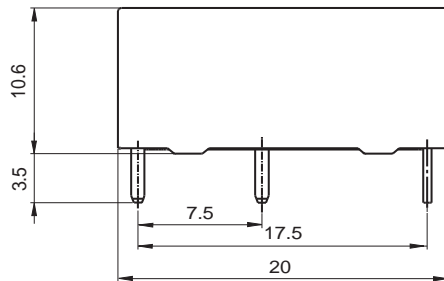
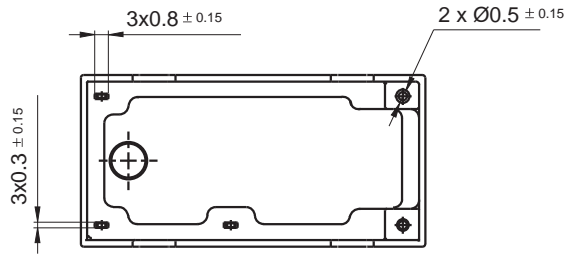

Wiring Diagram
(Bottom view)

PCB Layout
(Bottom view)

1 Form A

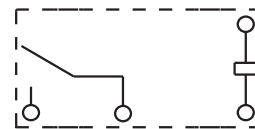
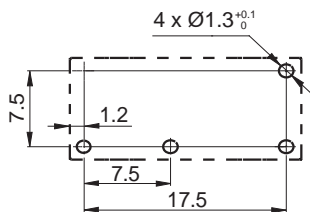

1 Form C

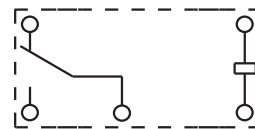
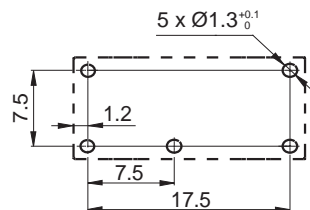

Remark: 1) In case of no tolerance shown in outline dimension: outline dimension *1mm, tolerance should be $\pm 0.2\text{mm}$; outline dimension *1mm and *5mm, tolerance should be $\pm 0.3\text{mm}$; outline dimension *5mm, tolerance should be $\pm 0.4\text{mm}$.
2) The tolerance without indicating for PCB layout is always $\pm 0.1\text{mm}$.

Disclaimer

The specification is for reference only. See to "Terminology and Guidelines" for more information. Specifications subject to change without notice. We could not evaluate all the performance and all the parameters for every possible application. Thus the user should be in a right position to choose the suitable product for their own application. If there is any query, please contact Hongfa for the technical service. However, it is the user's responsibility to determine which product should be used only.