

G2-LAURA-RS-P

~8° spot beam. Assembly with thinner white holder, installation tape and location pins.

TECHNICAL SPECIFICATIONS:

Dimensions	21.6 mm
Height	13.1 mm
Fastening	tape, pin
Colour	white
Box size	
Box weight	5.9 kg
Quantity in Box	pcs
ROHS compliant	yes ⓘ



MATERIAL SPECIFICATIONS:

Component	Type	Material	Colour
LAURA-RS	Single lens	PMMA	
LAURA-LT-PIN-XP-HLD-WHT	Holder	PC	
ROSE-TAPE	Tape	PU tape	

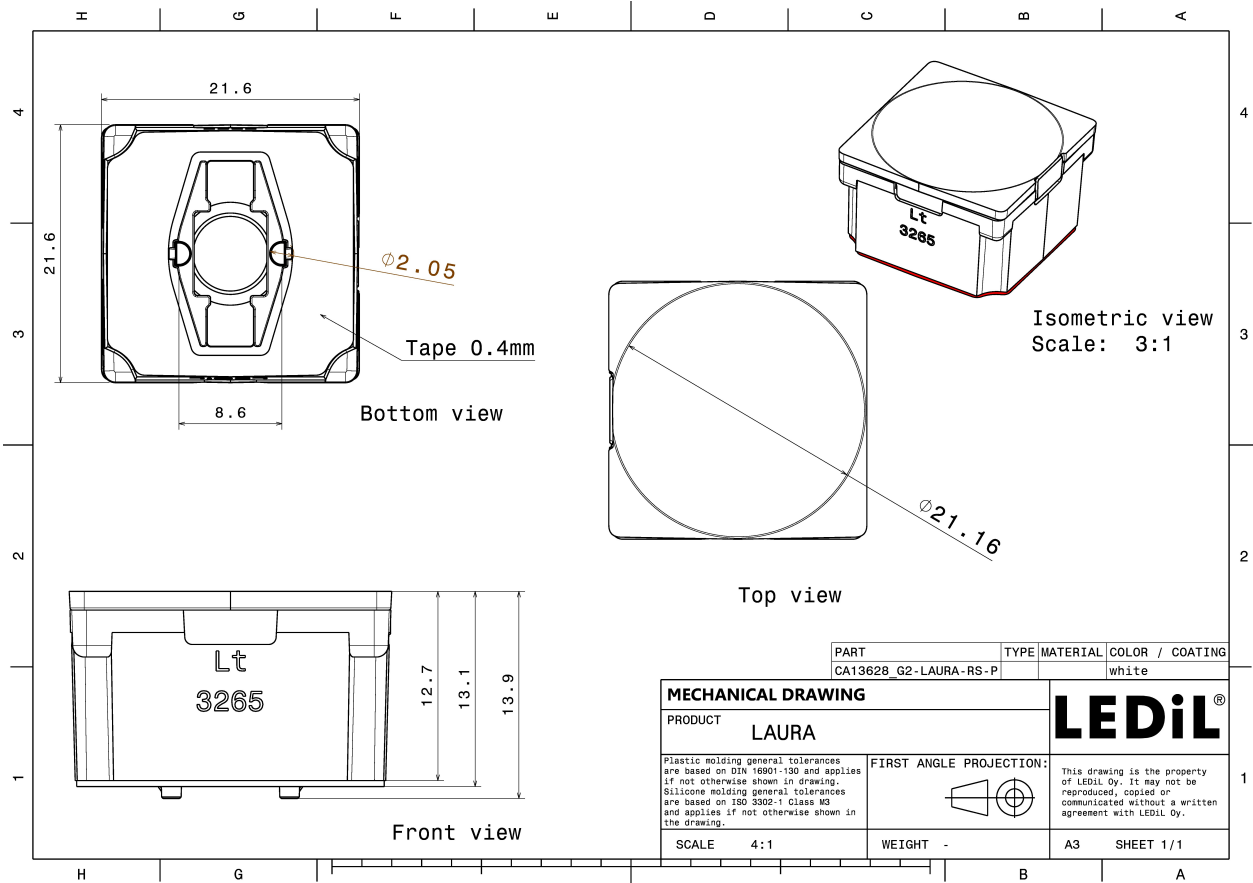

PHOTOMETRIC DATA (MEASURED):

CREE

LED XB-H
 FWHM 11.0°
 Efficiency 91 %
 Peak intensity 20.500 cd/lm
 LEDs/each optic 1
 Light colour White
 Required components:

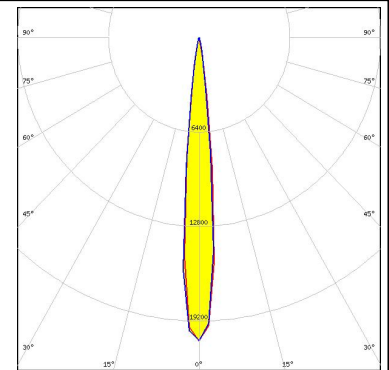

CREE

LED XP-E
 FWHM 8.0°
 Efficiency 93 %
 Peak intensity 33.200 cd/lm
 LEDs/each optic 1
 Light colour White
 Required components:

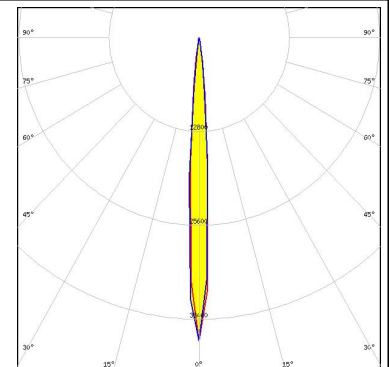
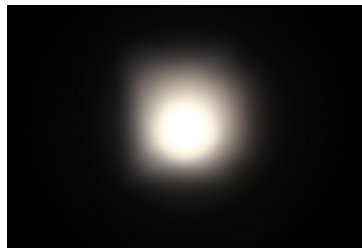

CREE

LED XP-E2
 FWHM 8.0°
 Efficiency 91 %
 Peak intensity 41.400 cd/lm
 LEDs/each optic 1
 Light colour White
 Required components:

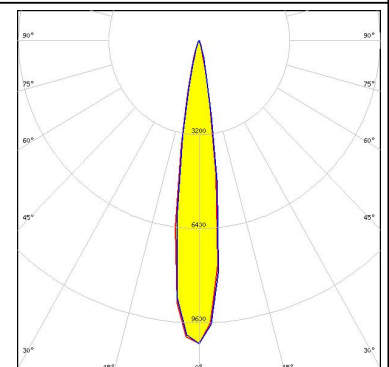
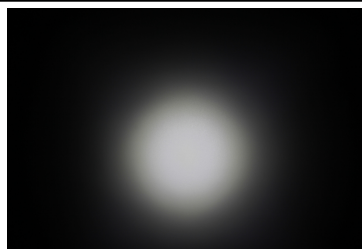

CREE

LED XP-L HD
 FWHM 16.0°
 Efficiency 90 %
 Peak intensity 10.320 cd/lm
 LEDs/each optic 1
 Light colour White
 Required components:

PHOTOMETRIC DATA (MEASURED):



LED XQ-E HI
 FWHM 5.0°
 Efficiency 94 %
 Peak intensity 65.300 cd/lm
 LEDs/each optic 1
 Light colour White
 Required components:

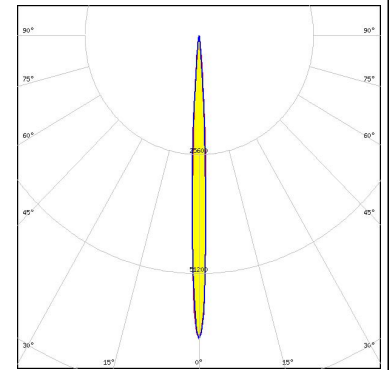
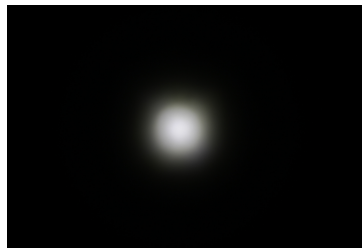

LED LUXEON 3030 2D (Round LES)
 FWHM 9.0°
 Efficiency 92 %
 Peak intensity 22.700 cd/lm
 LEDs/each optic 1
 Light colour White
 Required components:

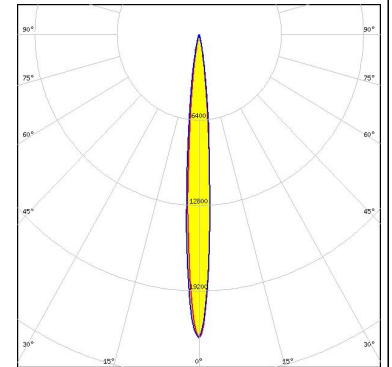
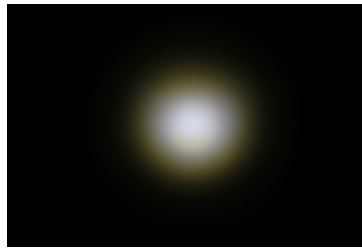

LED LUXEON TX
 FWHM 11.0°
 Efficiency 90 %
 Peak intensity 20.000 cd/lm
 LEDs/each optic 1
 Light colour White
 Required components:

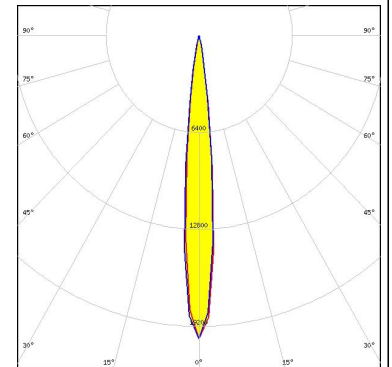

LED NCSxx19A
 FWHM 10.0°
 Efficiency 90 %
 Peak intensity 25.300 cd/lm
 LEDs/each optic 1
 Light colour White
 Required components:

