

Features

- 400 watts Peak Pulse Power (10/1000 μ s)
- Unidirectional and Bidirectional Protection
- Fast Response Time : Typically < 1ns
- Excellent Clamping Capability
- Built-in Strain relief
- Low inductance
- Low profile package
- High temperature solder: 260 $^{\circ}$ C/10 seconds at terminal

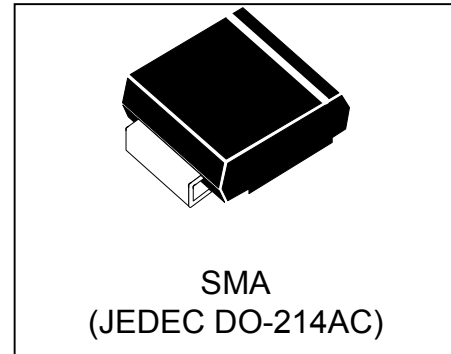

Mechanical Characteristics

- JEDEC DO-214AC package
- Molding compound flammability rating: UL 94V-0
- Marking: Marking Code
- Packaging: Tape and Reel per EIA 481
- RoHS &UL497B Compliant

Applications

- I/O Interfaces
- Power lines
- Automotive and Telecommunication
- Computers & Consumer Electronics
- Industrial Electronics

Absolute Maximum Rating			
Rating	Symbol	Value	Units
Peak Pulse Power ($t_p = 10/1000\mu s$) (see Note1,2& 3)	P_{PPM}	400	Watts
Peak pulse current (10/1000 μ s) (see Note2&3)	I_{PPM}	See Electrical Characteristics	A
Peak forward surge current (see Note4&5)	I_{FSM}	40	A
Power dissipation on infinite heat sink $T_L = 50^{\circ}C$ (Fig5)	P_D	3.3	W
Operating junction temperature range	T_J	-65 to + 150	$^{\circ}C$
Storage temperature range	T_{STG}	-65 to + 150	$^{\circ}C$

Note1: Peak Pulse Power Rating as Pulse Width ,per Fig1.

Note2: Peak Pulse Power or Current Derated above $T_A=25^{\circ}C$ Per Fig. 2 and Non-Repetitive Current Pulse, Per Fig.3.

Note3: Mounted on 5.0x5.0mm² copper pad to each terminal.

Note4: 8.3ms Single Half Sine Wave or Equivalent Square Wave.

Note5: Maximum Forward Surge Current only for Unidirectional Device per Fig6.

Electrical Characteristics

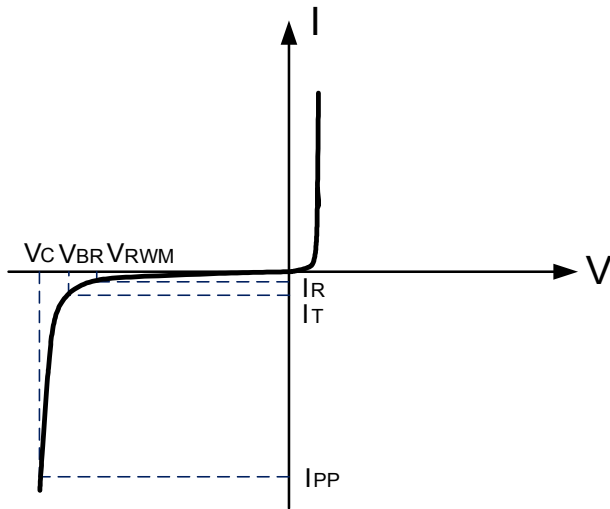

I-V curve of unidirectional device

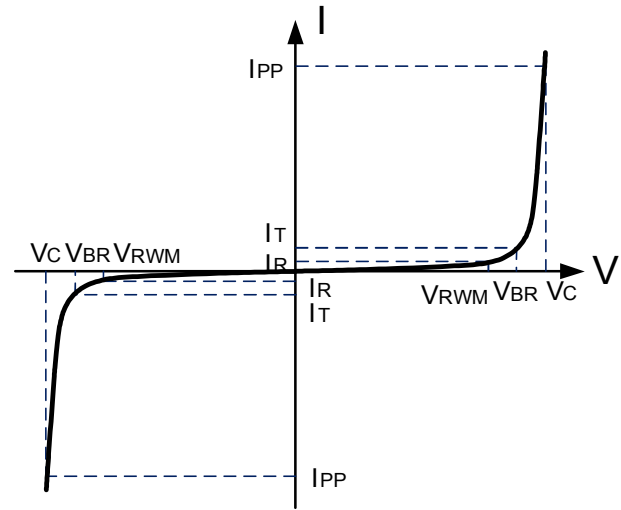

I-V curve of bidirectional device

Part Number		Reverse Stand off Voltage V_{RWM} (Volts)	Breakdown Voltage V_{BR} (Volts)@ I_T		Test Current I_T (mA)	Maximum Clamping Voltage V_c @ I_{PP} (Volts)	Maximum Peak Pulse Current I_{pp} (Amps)	Maximum Reverse Leakage I_R @ V_{RWM} (μ A)
UNI-POLAR	BI-POLAR		MIN	MAX				
WS5.0P4SMA	WS5.0P4SMA-B	5.0	6.40	7.07	10	9.2	43.5	800
WS6.0P4SMA	WS6.0P4SMA-B	6.0	6.67	7.37	10	10.3	38.8	800
WS6.5P4SMA	WS6.5P4SMA-B	6.5	7.22	7.98	10	11.2	35.7	500
WS7.0P4SMA	WS7.0P4SMA-B	7.0	7.78	8.60	10	12.0	33.3	200
WS7.5P4SMA	WS7.5P4SMA-B	7.5	8.33	9.21	1	12.9	31.0	100
WS8.0P4SMA	WS8.0P4SMA-B	8.0	8.89	9.83	1	13.6	29.4	50
WS8.5P4SMA	WS8.5P4SMA-B	8.5	9.44	10.40	1	14.4	27.8	20
WS9.0P4SMA	WS9.0P4SMA-B	9.0	10.00	11.10	1	15.4	26.0	10
WS10P4SMA	WS10P4SMA-B	10	11.10	12.30	1	17.0	23.5	5
WS11P4SMA	WS11P4SMA-B	11	12.20	13.50	1	18.2	22.0	5
WS12P4SMA	WS12P4SMA-B	12	13.30	14.7	1	19.9	20.1	5
WS13P4SMA	WS13P4SMA-B	13	14.40	15.90	1	21.5	18.6	1
WS14P4SMA	WS14P4SMA-B	14	15.60	17.20	1	23.2	17.2	1
WS15P4SMA	WS15P4SMA-B	15	16.70	18.50	1	24.4	16.4	1
WS16P4SMA	WS16P4SMA-B	16	17.80	19.70	1	26.0	15.4	1
WS17P4SMA	WS17P4SMA-B	17	18.90	20.90	1	27.6	14.5	1
WS18P4SMA	WS18P4SMA-B	18	20.00	22.10	1	29.2	13.7	1
WS20P4SMA	WS20P4SMA-B	20	22.20	24.50	1	32.4	12.3	1
WS22P4SMA	WS22P4SMA-B	22	24.40	26.90	1	35.5	11.3	1

Electrical Characteristics (Cont.)

Part Number		Reverse Stand off Voltage V_{RWM} (Volts)	Breakdown Voltage		Test Current I_T (mA)	Maximum Clamping Voltage $V_C@I_{PP}$ (Volts)	Maximum Peak Pulse Current I_{PP} (Amps)	Maximum Reverse Leakage $I_R@V_{RWM}$ (μ A)
			$V_{BR}(\text{Volts})@I_T$					
UNI-POLAR	BI-POLAR		MIN	MAX				
WS24P4SMA	WS24P4SMA-B	24	26.70	29.50	1	38.9	10.3	1
WS26P4SMA	WS26P4SMA-B	26	28.90	31.90	1	42.1	9.5	1
WS28P4SMA	WS28P4SMA-B	28	31.10	34.40	1	45.4	8.8	1
WS30P4SMA	WS30P4SMA-B	30	33.30	36.80	1	48.4	8.3	1
WS33P4SMA	WS33P4SMA-B	33	36.70	40.60	1	53.3	7.5	1
WS36P4SMA	WS36P4SMA-B	36	40.00	44.20	1	58.1	6.9	1
WS40P4SMA	WS40P4SMA-B	40	44.40	49.10	1	64.5	6.2	1
WS43P4SMA	WS43P4SMA-B	43	47.80	52.80	1	69.4	5.8	1
WS45P4SMA	WS45P4SMA-B	45	50.00	55.30	1	72.7	5.5	1
WS48P4SMA	WS48P4SMA-B	48	53.30	58.90	1	77.4	5.2	1
WS51P4SMA	WS51P4SMA-B	51	56.70	62.70	1	82.4	4.9	1
WS54P4SMA	WS54P4SMA-B	54	60.00	66.30	1	87.1	4.6	1
WS58P4SMA	WS58P4SMA-B	58	64.40	71.20	1	93.6	4.3	1
WS60P4SMA	WS60P4SMA-B	60	66.70	73.70	1	96.8	4.1	1
WS64P4SMA	WS64P4SMA-B	64	71.10	78.60	1	103	3.9	1
WS70P4SMA	WS70P4SMA-B	70	77.80	86.00	1	113	3.5	1
WS75P4SMA	WS75P4SMA-B	75	83.30	92.10	1	121	3.3	1
WS78P4SMA	WS78P4SMA-B	78	86.70	95.80	1	126	3.2	1
WS85P4SMA	WS85P4SMA-B	85	94.40	104	1	137	2.9	1
WS90P4SMA	WS90P4SMA-B	90	100	111	1	146	2.7	1
WS100P4SMA	WS100P4SMA-B	100	111	123	1	162	2.5	1
WS110P4SMA	WS110P4SMA-B	110	122	135	1	177	2.3	1
WS120P4SMA	WS120P4SMA-B	120	133	147	1	193	2.0	1
WS130P4SMA	WS130P4SMA-B	130	144	159	1	209	1.9	1
WS150P4SMA	WS150P4SMA-B	150	167	185	1	243	1.6	1
WS160P4SMA	WS160P4SMA-B	160	178	197	1	259	1.5	1
WS170P4SMA	WS170P4SMA-B	170	189	209	1	275	1.4	1
WS180P4SMA	WS180P4SMA-B	180	201	222	1	292	1.4	1
WS200P4SMA	WS200P4SMA-B	200	224	247	1	324	1.2	1

Electrical Characteristics (Cont.)

Part Number		Reverse Stand off Voltage V_{RWM} (Volts)	Breakdown Voltage V_{BR} (Volts)@ I_T		Test Current I_T (mA)	Maximum Clamping Voltage $V_C@I_{PP}$ (Volts)	Maximum Peak Pulse Current I_{pp} (Amps)	Maximum Reverse Leakage $I_R@V_{RWM}$ (μ A)
UNI-POLAR	BI-POLAR		MIN	MAX				
WS220P4SMA	WS220P4SMA-B	220	246	282	1	356	1.1	1
WS250P4SMA	WS250P4SMA-B	250	279	309	1	405	1.0	1
WS300P4SMA	WS300P4SMA-B	300	335	371	1	486	0.8	1
WS350P4SMA	WS350P4SMA-B	350	391	432	1	567	0.7	1
WS400P4SMA	WS400P4SMA-B	400	447	492	1	648	0.6	1
WS440P4SMA	WS440P4SMA-B	440	492	543	1	713	0.6	1

Typical Characteristics

Figure 1: Peak Pulse Power Rating Curve

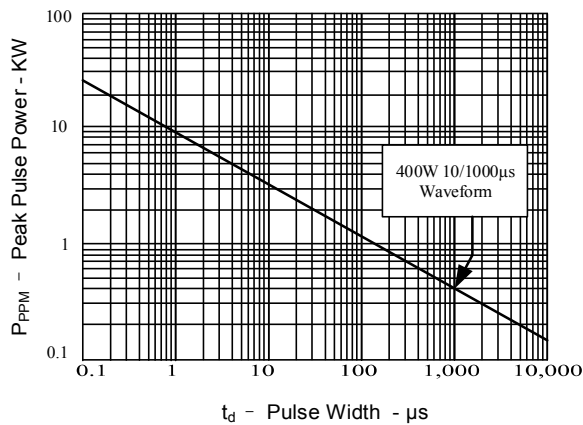

Figure 2: Pulse Derating Curve

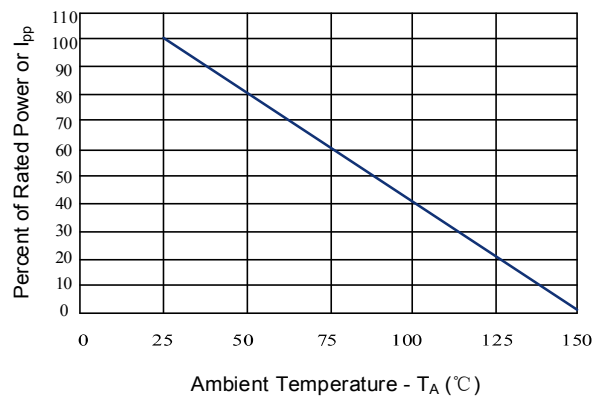

Figure 3: Pulse Waveform

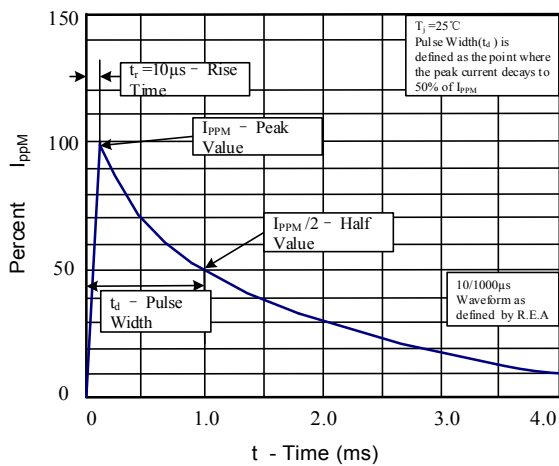

Figure 4: Typical Junction Capacitance

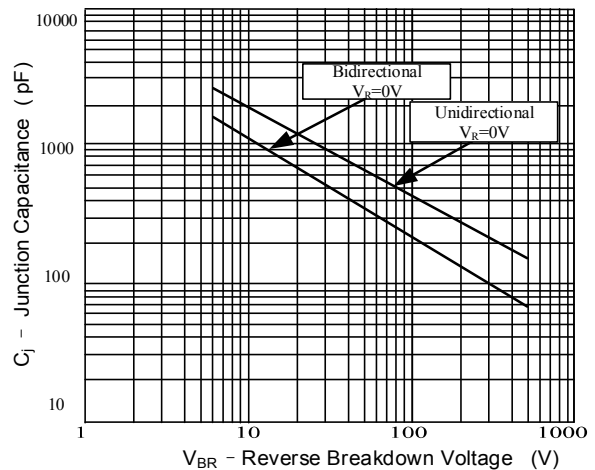

Figure 5: Steady State Power Dissipation Derating Curve

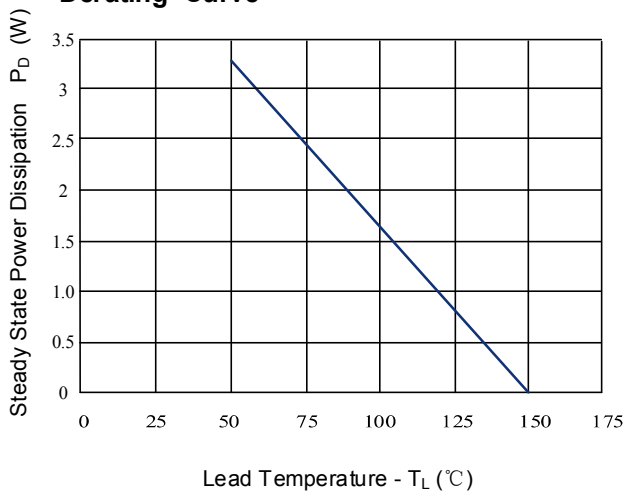
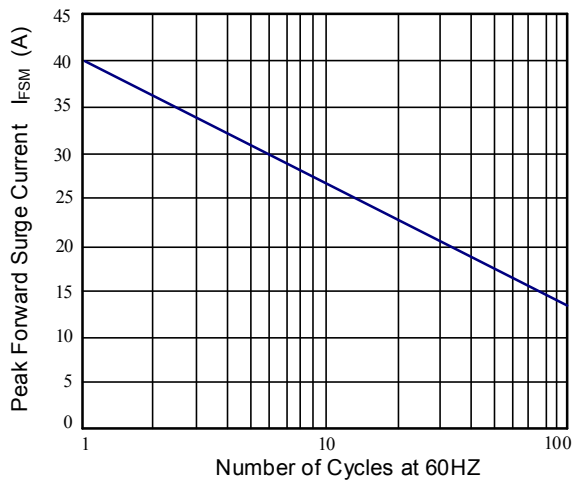
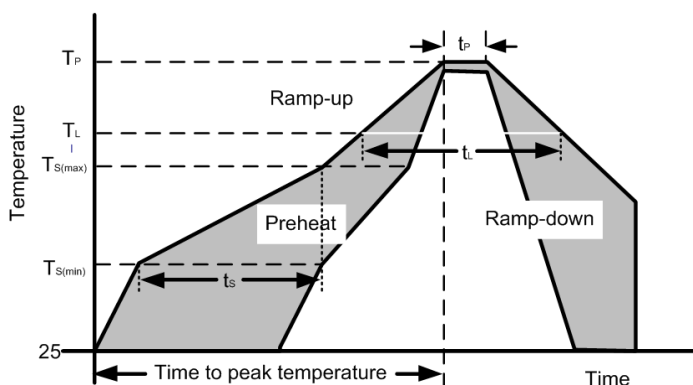

Figure 6: Maximum Non-Repetitive Forward Surge Current Only Unidirectional



Soldering Parameters

Reflow Condition		
Pre Heat	Temperature min ($T_{s(min)}$)	150°C
	Temperature max ($T_{s(max)}$)	200°C
	Time (min to max) (t_s)	60-190 s
Average ramp up rate (Liquidus Temp) (T_L) to peak		3°C/s max
Ts(max) to TL - Ramp-up Rate		3°C/s max
Reflow	Temperature (T_L) (Liquidus)	217°C
	Temperature (t_L)	60-150 s
Peak Temperature (T_P)		260 ^{+0/-5} °C
Time within actual peak Temperature (t_p)		20-40 s
Ramp-down Rate		5°C/s max
Time 25°C to peak Temperature (T_P)		8 minutes max
Do not exceed		260°C



Outline Drawing – SMA(DO-214AC)

Ref. (mm)	Millimeters	
	Min.	Max.
A	1.980	2.290
A1	-	0.203
B	1.250	1.650
E	3.990	4.500
E1	4.930	5.280
D	2.540	2.790
L	0.780	1.520

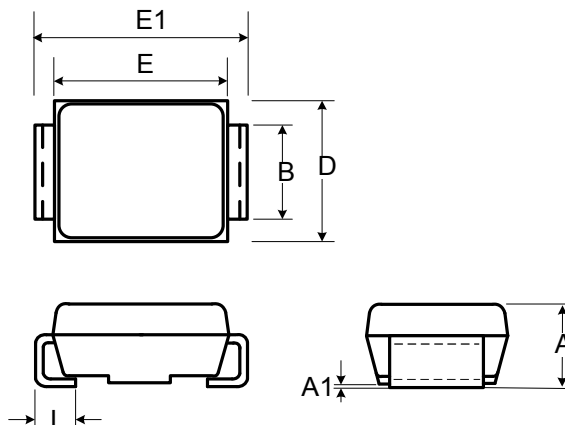

Recommended Solder Pad Layout

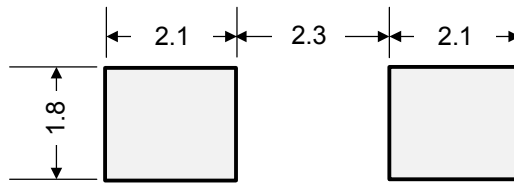

Dimensions in mm

Part Numbering System

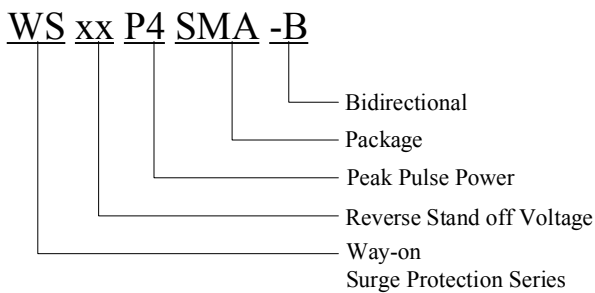

Part Marking System

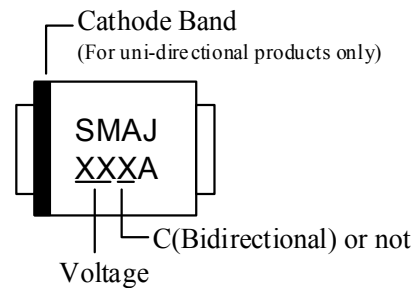

Package Information

Package Type	Description	Quantity (pcs)	Standard
SMA(DO-214AC)	Tape & Reel -12mm/13" tape	5000	EIA-481-D

CONTACT INFORMATION

CYG WAYON CIRCUIT PROTECTION CO., LTD.

No.1001, Shiwan(7) Road, Pudong District, Shanghai, P.R.China.201207

Tel: +86-21-68969993 Fax: 86-21-50757680 Email: market@way-on.com

WAYON website: <http://www.way-on.com>

For additional information, please contact your local Sales Representative.

CYG WAYON ® is registered trademarks of Wayon Corporation.

Specifications are subject to change without notice.
The device characteristics and parameters in this data sheet can and do vary in different applications and actual device performance may vary over time.
Users should verify actual device performance in their specific applications.