



*Jinchang Electron Global Service*

GPS&GLONASS+LTE MIMO+WIFI MIMO Antenna

**JCE604LMWM**



**JIAXING JINCHANG ELECTRONIC TECHNOLOGY CO.,LTD**

Add: 398#, Zhenye Road, South Street, Jiaxing, Zhejiang, China

Http:// [www.jinchanggps.com](http://www.jinchanggps.com)

E-mail: [jcgps@vip.163.com](mailto:jcgps@vip.163.com)

Tel: 86-0573-83692157/83692605/83958637 Fax: 86-0573-83958635

**DIMENSIONS**

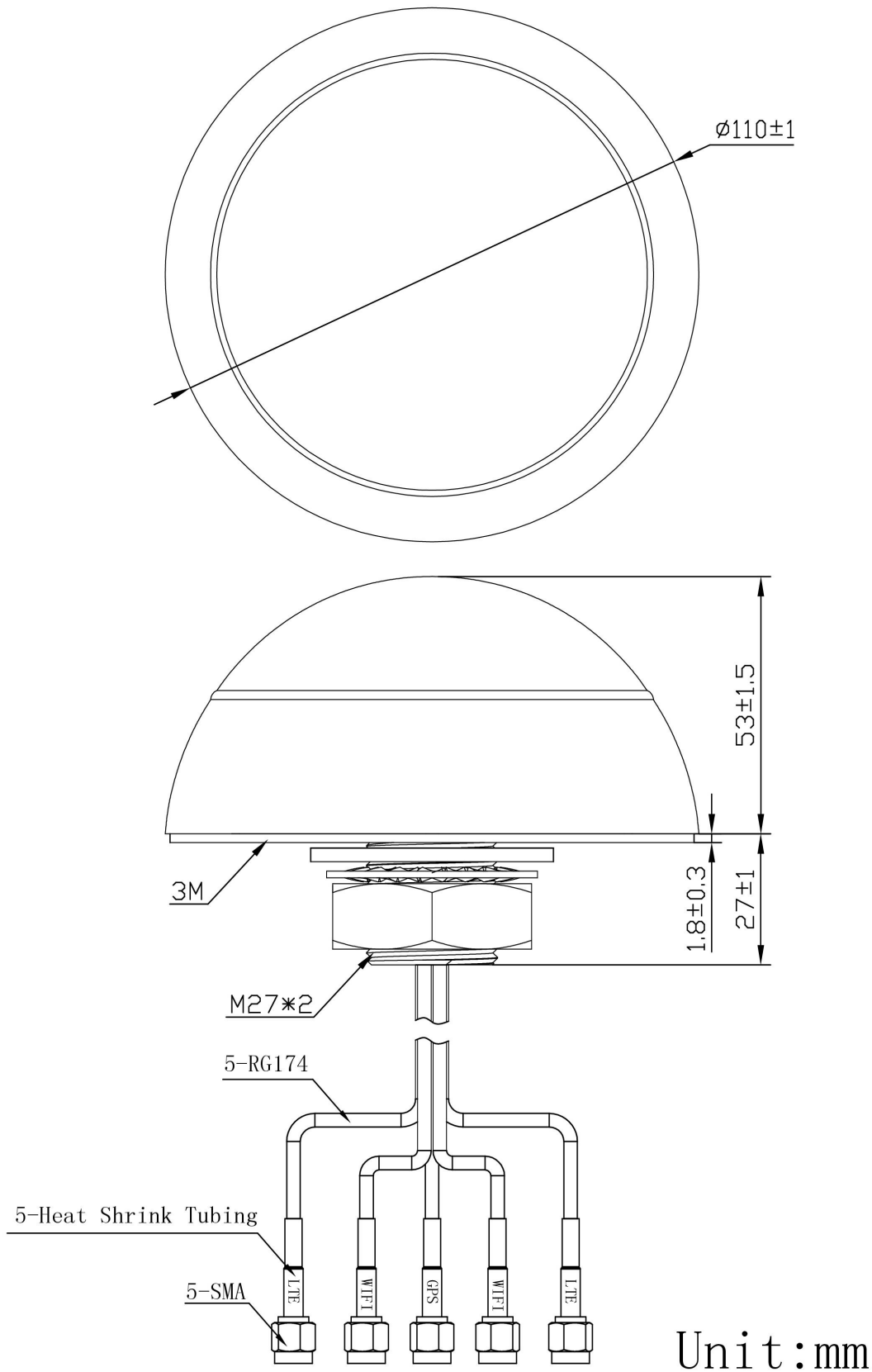

**SPECIFICATIONS**

Item	Specifications	
GPS&GLONASS Antenna	Frequency Range	1575.42~1610MHz
	Polarization	RHCP
	Impedance	50 Ω
	Dimension	25*25*6mm
	Gain	28 ± 2dB
	Noise Figure	≤ 1.5dB
	Supply Voltage	3~5V DC
	Current Consumption	< 15mA
	V.S.W.R	< 2.0
LTE Antenna MIMO	Frequency Range	698~960MHz/1710~2690MHz
	V.S.W.R	< 3.0
	Polarization	Linear
	Gain	3dBi
	Impedance	50Ω
WIFI Antenna MIMO	Frequency Range	2400~2483.5MHz/4900~5825MHz
	V.S.W.R	< 2.5
	Polarization	Linear
	Gain	2dBi
	Impedance	50Ω
Mechanical	Cable	RG174
	Connector	SMA or others
	Radome Material	ABS
	Mounting Method	Screw
Environmental	Operating Temperature	-40℃~+85℃
	Relative Humidity	Up to 95%
	Ingress Protection	IP67 (exclude cable outlet)
	Vibration	10 to 55Hz with 1.5mm amplitude 2hours
	Environmentally Friendly	ROHS Compliant

**Radiation Pattern**

GPS Antenna

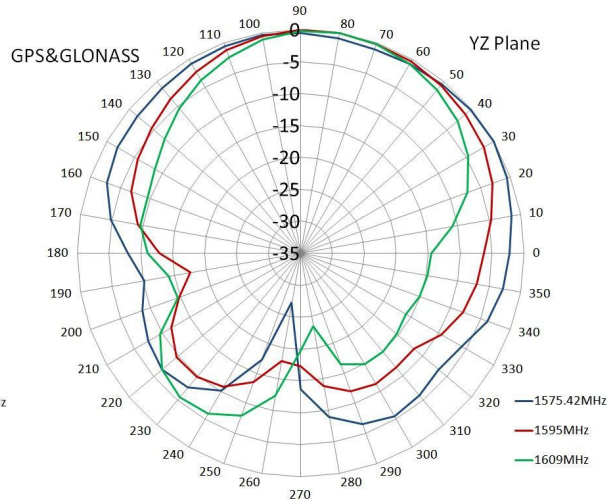
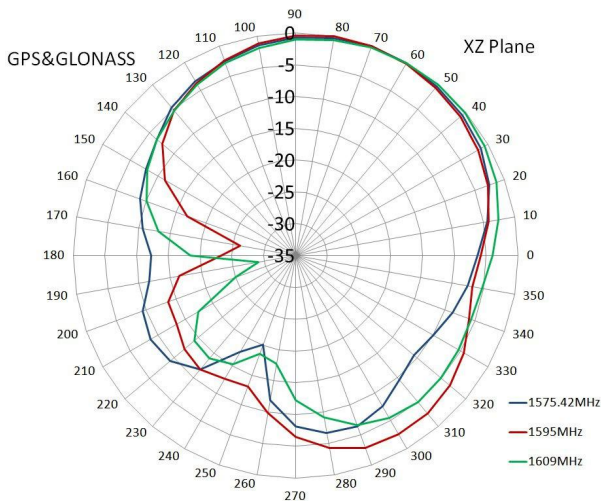
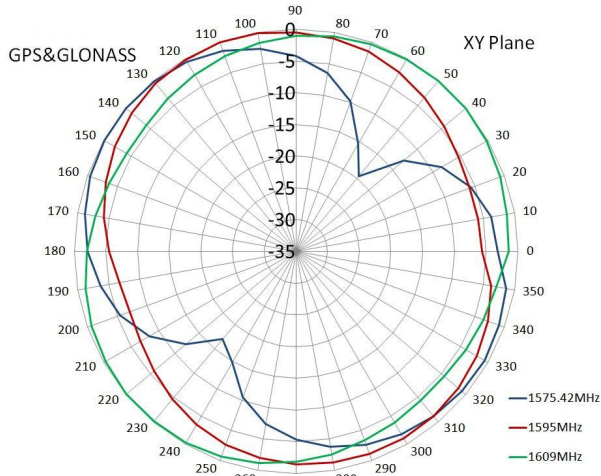

LTE Antenna

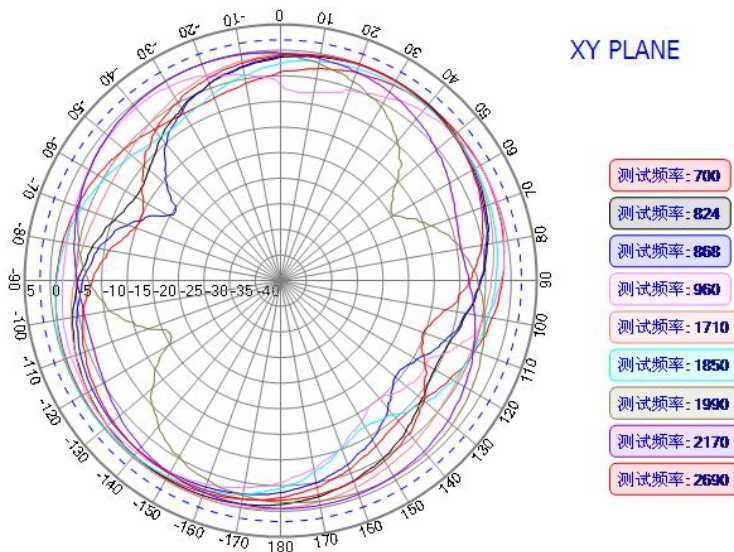

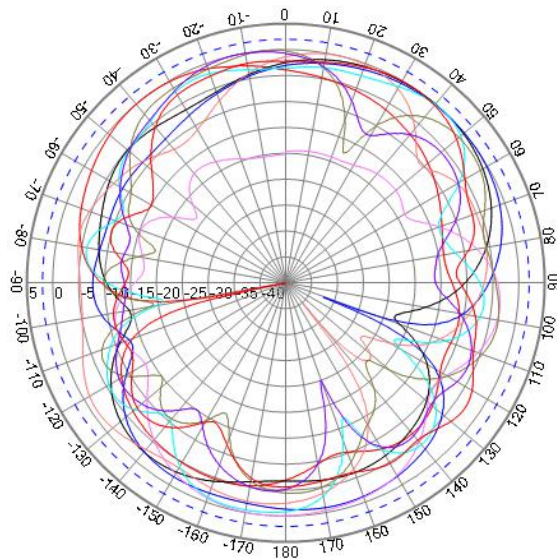

XZ PLANE

- 测试频率: 700
- 测试频率: 824
- 测试频率: 868
- 测试频率: 960
- 测试频率: 1710
- 测试频率: 1850
- 测试频率: 1990
- 测试频率: 2170
- 测试频率: 2690

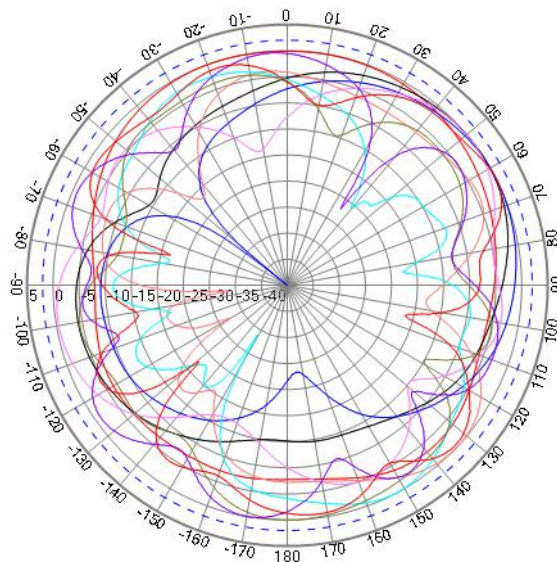

YZ PLANE

- 测试频率: 700
- 测试频率: 824
- 测试频率: 868
- 测试频率: 960
- 测试频率: 1710
- 测试频率: 1850
- 测试频率: 1990
- 测试频率: 2170
- 测试频率: 2690

WIFI Antenna

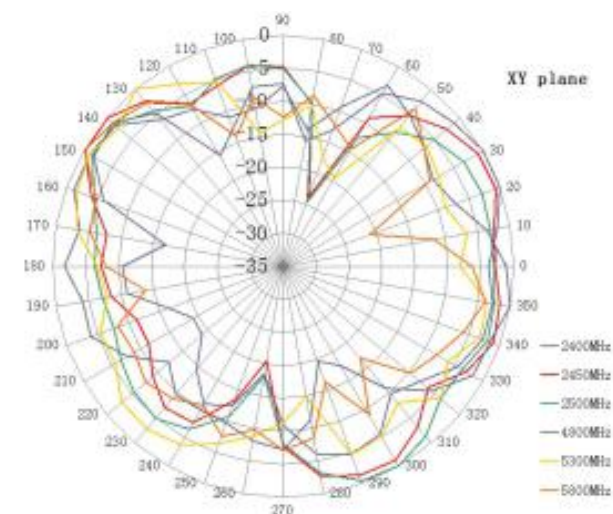



Jinchang Electron Global Service

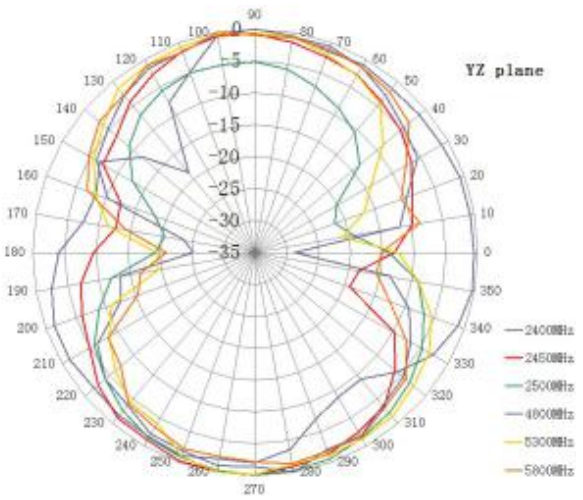
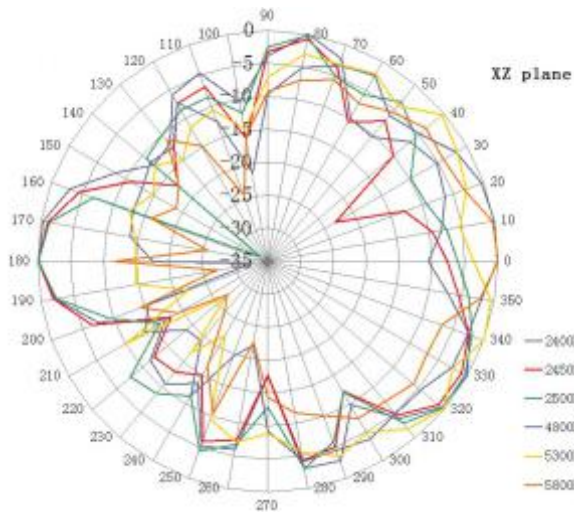

JIAXING JINCHANG ELECTRONIC TECHNOLOGY CO.,LTD

Add: 398#,Zhenye Road, South Street, Jiaxing, Zhejiang, China

Http:// www.jinchanggps.com

E-mail:jcgps@vip.163.com

Tel: 86-0573-83692157/83692605/83958637 Fax:86-0573-83958635