

THIS DOCUMENT IS SUBJECT TO CHANGE WITHOUT NOTICE. IT IS CONFIDENTIAL AND A PROPERTY OF Amphenol LTW. DISCLOSURE TO THIRD PARTY HAS TO BE AUTHORIZED BY Amphenol LTW.

REV.	ECN NO.	DATE	SIGN	DESCRIPTION
B	LEN1780901~902	2017-08-09	Frank Deng	Add Package

**ALTW**  
CONFIDENTIAL  
2017-08-09  
R&D DEPT.

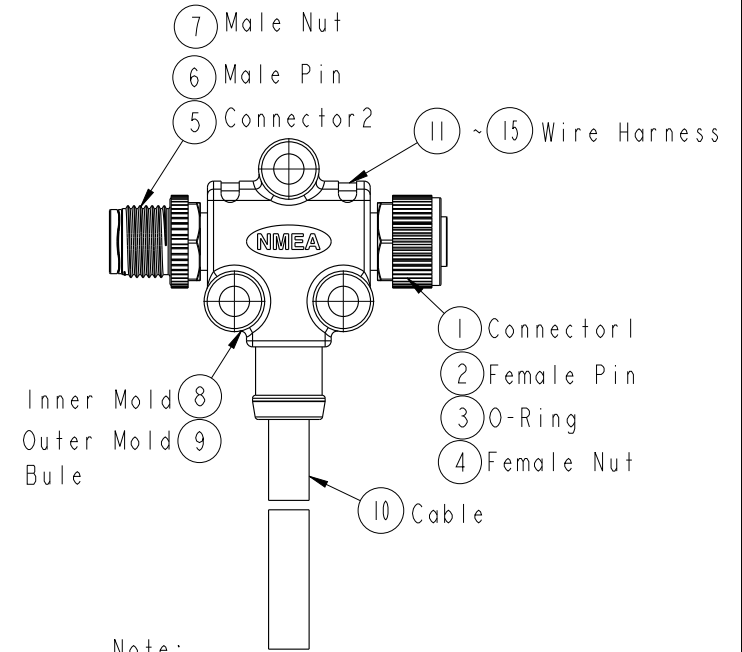
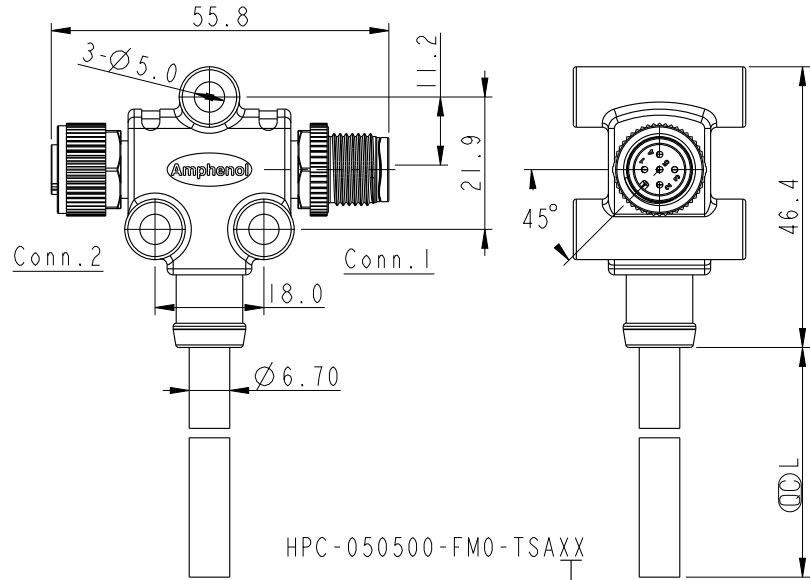
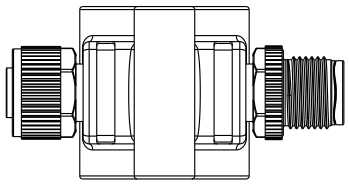

**ALTW**  
DCC. DEPT.  
CONFIDENTIAL  
2017.08.17  
ISSUED

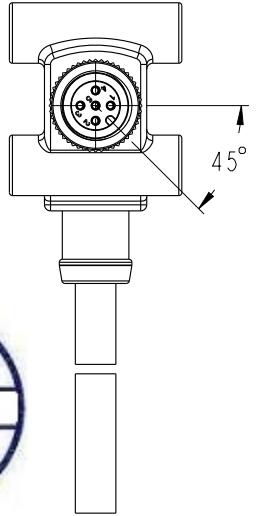

Note:  
 \*  $\varnothing$  Important Dimension To Check.  
 \* Waterproof Rate: IP68  
 In 1 meter water within 24 hours  
 \* Connector: PU, Black  
 \* Nut: PA66, Black  
 \* Pin: Copper Alloy, Gold Plated 30u"  
 \* Wire Harness: UL1061, 22AWG  
 \* Cable: CL2, (24#\*1P+A/M)+(22#\*1P+A/M)+D+B, PVC UV Cable, OD=6.7mm, Black  
 \* Cable Length Tolerance: 01M:±40mm  
 02M~05M:±60mm  
 06M~10M:±100mm  
 11M~30M:±200mm  
 31M~99M:±500mm

XX: 01~99Meters  
 01: 01Meter  
 02: 02Meters  
 ..  
 99: 99Meters  
 Cable Length(L): 01~99Meters

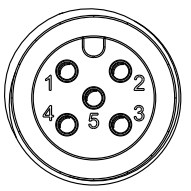
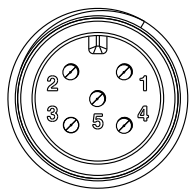

Conn.1  
Pin Assignments  
Front View

Conn.2  
Pin Assignments  
Front View

5	Blue 藍	5	Blue 藍 24#	Twist
4	White 白	4	White 白 24#	
3	Black 黑	3	Black 黑 22#	Twist
2	Red 紅	2	Red 紅 22#	
1	Green 綠	1	Drain 22#	
Conn.1	Wire Color	Conn.2	Cable	

UNIT:mm   
 TOLERANCE ±0.50mm

TITLE			
NMEA2000 Micro-C T Cable			
SCALE	SIZE	SHEET	OF
1:2	A4	1	2
REV.	WC-REV.	☉: Inspection item	
B	A.1		

**Amphenol LTW**  
安費諾亮泰企業股份有限公司

ITEM NO	DRAWN BY	DATE
	Frank Deng	2017-08-09
DWG NO	CHECKED BY	DATE
HPC-050500-FM0-TSAXX	Fisher Wang	2017-08-09
CUSTOMER	APPROVED BY	DATE
ALTW	Kevin Hu	2017-08-09

THIS DOCUMENT IS SUBJECT TO CHANGE WITHOUT NOTICE. IT IS CONFIDENTIAL AND A PROPERTY OF Amphenol LTW. DISCLOSURE TO THIRD PARTY HAS TO BE AUTHORIZED BY Amphenol LTW.

1 2 3 4 5 6 7 8

F  
E  
D  
C  
B  
A



PN	Dimension Of Roll
HPC-050500-FM0-TSA02	
HPC-050500-FM0-TSA05	
HPC-050500-FM0-TSA10	

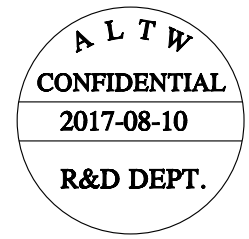

UNIT:mm		
---------	--	--

TITLE NMEA2000 Micro-C T Cable		
SCALE 1:2	SIZE A4	SHEET 2 OF 2
REV. B	WC-REV. A.1	QC: Inspection item

**Amphenol LTW**  
安費諾亮泰企業股份有限公司

ITEM NO	DRAWN BY Frank Deng	DATE 2017-08-09
DWG NO HPC-050500-FM0-TSAXX	CHECKED BY Fisher Wang	DATE 2017-08-09
CUSTOMER ALTW	APPROVED BY Kevin Hu	DATE 2017-08-09

1 2 3 4 5 6 7 8 FMW10702-01-02A1