

THIS DOCUMENT IS SUBJECT TO CHANGE WITHOUT NOTICE. IT IS CONFIDENTIAL AND A PROPERTY OF Amphenol LTW. DISCLOSURE TO THIRD PARTY HAS TO BE AUTHORIZED BY Amphenol LTW.

REV.	ECN NO.	DATE	SIGN	DESCRIPTION

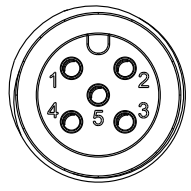

Conn. 1&3  
Pin Assignments  
Front View

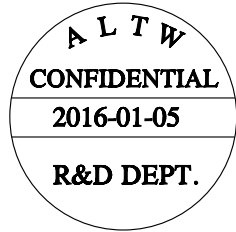
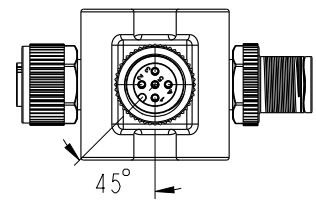
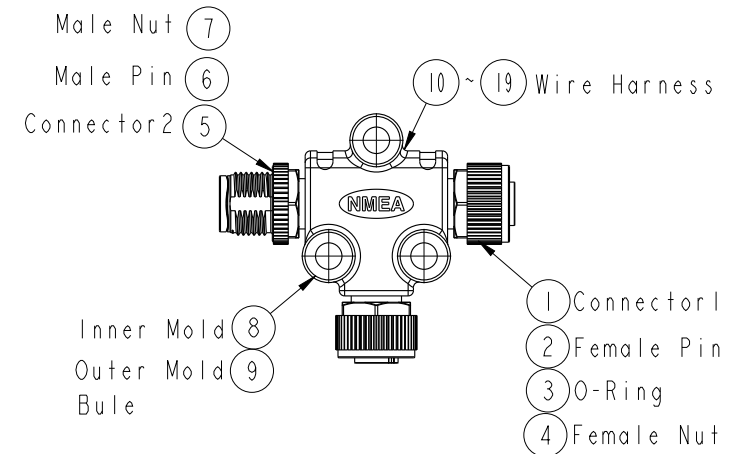
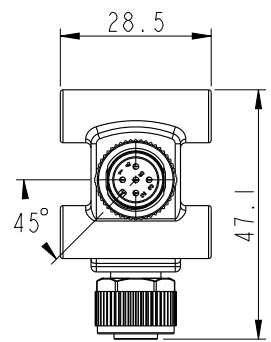
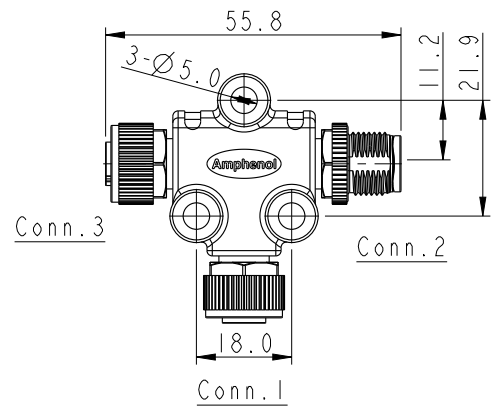
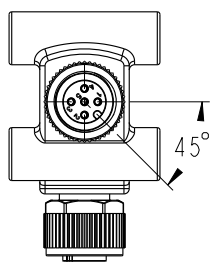
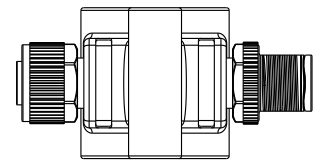
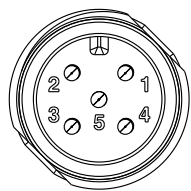

Conn. 2  
Pin Assignments  
Front View

Blue 藍	5	5	5
White 白	4	4	4
Black 黑	3	3	3
Red 紅	2	2	2
Green 綠	1	1	1
Wire Color	Conn.1	Conn.2	Conn.3
	Pin Out		

Note:  
 \* (CC) Important Dimension To Check.  
 \* Waterproof Rate: IP68  
 In 1 meter water within 24 hours  
 \* Connector: PU, Black  
 \* Nut: Zinc Alloy, Nickel Plated  
 \* Pin: Copper Alloy, Gold Plated 30u"  
 \* Outer Mold: PU, Blue  
 \* Wire Harness: UL1061, 22AWG

UNIT: mm   
 TOLERANCE ±0.50mm

TITLE NMEA2000 Micro-C T Adaptor			
SCALE 1:1	SIZE A4	SHEET 1 OF 1	
REV. A	WC-REV. A.2	CC: Inspection item	

**Amphenol LTW**  
 安費諾亮泰企業股份有限公司

ITEM NO. HMC-050505-FMF-TS001	DRAWN BY Cary	DATE 2016-01-05
DWG NO. HMC-050505-FMF-TS001	CHECKED BY Yulong	DATE 2016-01-05
CUSTOMER ALTW	APPROVED BY Jerry	DATE 2016-01-05