

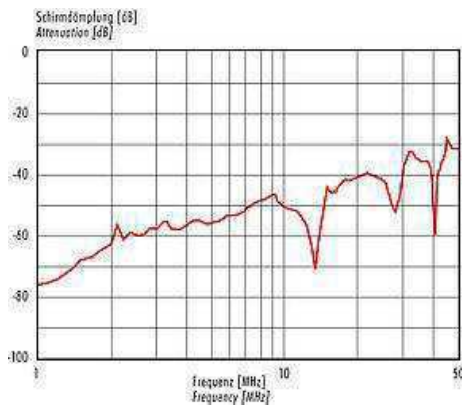

Conntherm

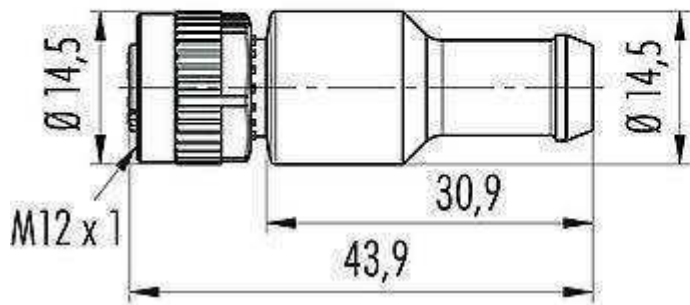

Pinbelegung

Pin assignment



- 1 nicht konfektioniert / *not assembled*
- 2 nicht konfektioniert / *not assembled*
- 3 nicht konfektioniert / *not assembled*
- 4  Widerstand / *Resistor*
- 5  120 Ω

Conntherm

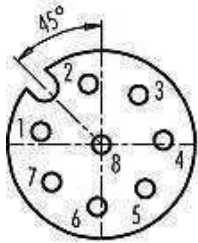

	X	Y
1	-2,69	0,57
2	-0,57	2,69
3	1,66	2,20
4	2,75	0,19
5	1,94	-1,94
6	-0,19	-2,75
7	-2,20	-1,66
8	0,00	0,00

- 1 weiß/white
- 2 braun/brown
- 3 grün/green
- 4 gelb/yellow
- 5 grau/grey
- 6 rosa/pink
- 7 blau/blue
- 8 rot/red

Geschirmte Versionen: Schirm auf Gehäuse oder Pin 8
Shielded versions: shield on housing or pin 8

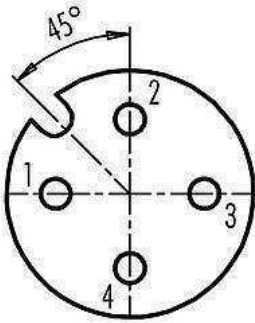

- 1 braun/brown
- 2 weiß/white
- 3 blau/blue
- 4 schwarz/black

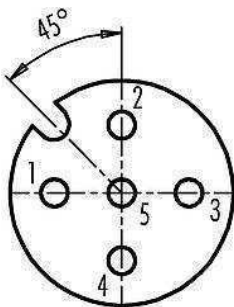

- 1 braun/brown
- 2 weiß/white
- 3 blau/blue
- 4 schwarz/black
- 5 grau/grey